



# Altivar Soft Starter ATS480

Soft starters for process and  
infrastructures from 4 to 900 kW

Life Is On

**Schneider**  
Electric

# Quick access to product information

## Get technical information about your product

References

**Modicon TM3**  
I/O expansion modules for Modicon controllers  
Analog I/O modules

Reference	Number and type of channels	Input range	Output range	Resolution	Input terminal block	Reference	Weight
240A00000	24 channels	-10...+10VDC 0...20mA I, 20mA	10...20VDC 10...20mA I, 20mA	10 bits	Terminal block	240A00000	0,118 kg
240A00001	24 channels	-10...+10VDC 0...20mA I, 20mA	10...20VDC 10...20mA I, 20mA	10 bits	Terminal block	240A00001	0,118 kg
240A00002	24 channels	-10...+10VDC 0...20mA I, 20mA	10...20VDC 10...20mA I, 20mA	10 bits	Terminal block	240A00002	0,118 kg
240A00003	24 channels	-10...+10VDC 0...20mA I, 20mA	10...20VDC 10...20mA I, 20mA	10 bits	Terminal block	240A00003	0,118 kg
240A00004	24 channels	-10...+10VDC 0...20mA I, 20mA	10...20VDC 10...20mA I, 20mA	10 bits	Terminal block	240A00004	0,118 kg
240A00005	24 channels	-10...+10VDC 0...20mA I, 20mA	10...20VDC 10...20mA I, 20mA	10 bits	Terminal block	240A00005	0,118 kg
240A00006	24 channels	-10...+10VDC 0...20mA I, 20mA	10...20VDC 10...20mA I, 20mA	10 bits	Terminal block	240A00006	0,118 kg
240A00007	24 channels	-10...+10VDC 0...20mA I, 20mA	10...20VDC 10...20mA I, 20mA	10 bits	Terminal block	240A00007	0,118 kg
240A00008	24 channels	-10...+10VDC 0...20mA I, 20mA	10...20VDC 10...20mA I, 20mA	10 bits	Terminal block	240A00008	0,118 kg
240A00009	24 channels	-10...+10VDC 0...20mA I, 20mA	10...20VDC 10...20mA I, 20mA	10 bits	Terminal block	240A00009	0,118 kg
240A00010	24 channels	-10...+10VDC 0...20mA I, 20mA	10...20VDC 10...20mA I, 20mA	10 bits	Terminal block	240A00010	0,118 kg
240A00011	24 channels	-10...+10VDC 0...20mA I, 20mA	10...20VDC 10...20mA I, 20mA	10 bits	Terminal block	240A00011	0,118 kg
240A00012	24 channels	-10...+10VDC 0...20mA I, 20mA	10...20VDC 10...20mA I, 20mA	10 bits	Terminal block	240A00012	0,118 kg
240A00013	24 channels	-10...+10VDC 0...20mA I, 20mA	10...20VDC 10...20mA I, 20mA	10 bits	Terminal block	240A00013	0,118 kg
240A00014	24 channels	-10...+10VDC 0...20mA I, 20mA	10...20VDC 10...20mA I, 20mA	10 bits	Terminal block	240A00014	0,118 kg
240A00015	24 channels	-10...+10VDC 0...20mA I, 20mA	10...20VDC 10...20mA I, 20mA	10 bits	Terminal block	240A00015	0,118 kg
240A00016	24 channels	-10...+10VDC 0...20mA I, 20mA	10...20VDC 10...20mA I, 20mA	10 bits	Terminal block	240A00016	0,118 kg
240A00017	24 channels	-10...+10VDC 0...20mA I, 20mA	10...20VDC 10...20mA I, 20mA	10 bits	Terminal block	240A00017	0,118 kg
240A00018	24 channels	-10...+10VDC 0...20mA I, 20mA	10...20VDC 10...20mA I, 20mA	10 bits	Terminal block	240A00018	0,118 kg
240A00019	24 channels	-10...+10VDC 0...20mA I, 20mA	10...20VDC 10...20mA I, 20mA	10 bits	Terminal block	240A00019	0,118 kg
240A00020	24 channels	-10...+10VDC 0...20mA I, 20mA	10...20VDC 10...20mA I, 20mA	10 bits	Terminal block	240A00020	0,118 kg

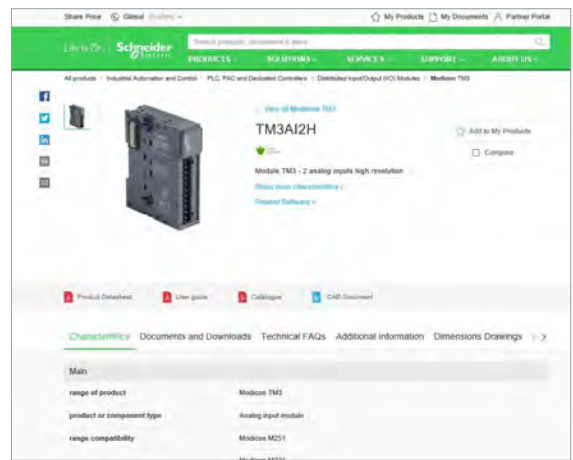

Each commercial reference presented in a catalog contains a hyperlink. Click on it to obtain the technical information of the product:

- Characteristics, Dimensions and drawings, Mounting and clearance, Connections and schemas, Performance curves
- Product image, Instruction sheet, User guide, Product certifications, End of life manual

## Find your catalog

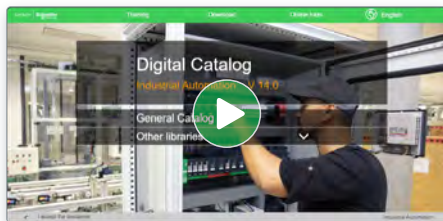

- > With just 3 clicks, you can access the Industrial Automation and Control catalogs, in both English and French
- > Consult digital automation catalogs at [Digi-Cat Online](#)

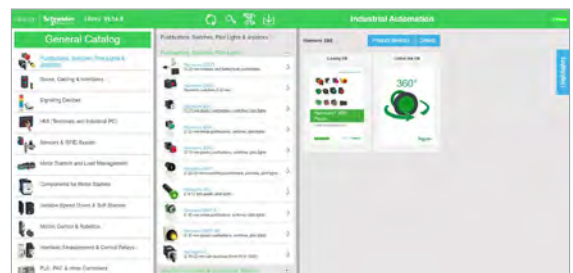

- Up-to-date catalogs
- Embedded product selectors, 360° pictures
- Optimized search by commercial references

## Select your training



- > Find the right [Training](#) for your needs on our Global website
- > Locate the training center with the selector tool, using this [link](#)

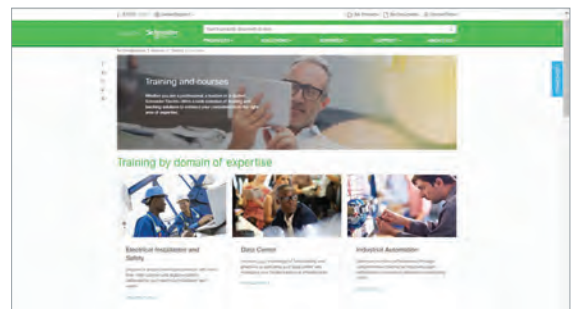

Life Is On

Schneider Electric



# Digital tools to quickly select your soft starter solution

## Product selector for ATS480

- Easy selection of the ATS480 commercial reference
- Expand it with options and accessories
- Get the Bill of Material in standard format
- Drop it into the product cart
- Access technical information and documentation



[Scan or click on the QR code](#)

## EcoStruxure™ Motor Control Configurator

- From your application, select your soft starter reference
- Expand it with coordinated combination, options, and accessories
- Convert into Bill of Material, add the product to the cart
- Directly access product documentation
- Save, rework, share your solution with unique ID



[Scan or click on the QR code](#)

## EcoStruxure™ Motor Management Design

- From your project, perform electrical design calculation
- Compare direct-on-line, soft starter, and variable speed drive
- Verify starting feasibility from mechanical standpoint
- Verify that power factor and harmonics levels objectives are met
- Build a complete Motor Management solution: circuit breakers, soft starters, drives, contactors, MCC panels, power quality monitoring
- Get a summary report with calculations and recommended offers



[Scan or click on the QR code](#)

Life Is On

**Schneider**  
Electric



# Altivar

## Discover **Altivar**

Variable speed drives and soft starters

**Altivar** variable speed drives and soft starters deliver top performance in motor control applications across machines, processes, and buildings. With built-in intelligence, these smart connected devices gather and share data to improve operational efficiency, safety, and reliability.

## Explore our offer

- **Altivar Process**
- **Altivar Machine**
- **Altivar Building**
- **Altivar Soft Starters**

Life Is On

**Schneider**  
Electric

# Green Premium™

## Enhance sustainability with Altivar™ Soft Starter ATS480

### Superior environmental performance thanks to upgradability and modernization solutions

Altivar™ Soft Starter ATS480 is **RoHS** and **REACH** compliant

- Transparent environment information
- Life Cycle Analysis, compliant with ISO 14025
- Circularity Profile

Altivar™ Soft Starter ATS480 brings key benefits to help you achieve **superior upgradable performance** by enhancing its embedded functionality and performance capabilities for both hardware and software. ATS480 also extends the service life of ATS48 equipment: ATS480 replaces ATS48 while keeping the same footprint, circuit breaker, contactors, cables, and behavior of the process, making way for evolution.

The **additional power options** and the **cybersecurity-compliant firmware upgradability** capabilities of the Altivar Soft Starter ATS480 can help you to maximize process continuity and operation, as well as reduce your operational expenses, by avoiding the need to replace your soft starter or modify your existing installation as a retrofit.

#### Benefits

- Enable a **secure and digital area**
- Reduce your **engineering time and cost**
- Help to **secure your operations**
- **Reduce downtime**
- **Extend the service life** of ATS48 equipment
- Make way for **evolution**
- **Preserve your initial investment**



Experience our offer on  
[se.com/green-premium](https://se.com/green-premium)

#### Communication and Wi-Fi modules

The additional communication modules allow you to easily integrate Altivar Soft Starter ATS480 in your scalable automation system. Together with the Wi-Fi access point, they bring easy access to the real data provided by the soft starter, aiding its digitization and easy integration in Industry 4.0 technologies.

#### Cybersecurity-compliant firmware upgrade

You have the possibility to upgrade the Altivar Soft Starter ATS480 firmware. Available on [se.com](https://se.com), the firmware is digitally signed and can only be applied if authenticity is verified by the ATS480.

#### Graphic display terminal and dynamic QR code

In addition to the detailed warnings and detected errors available on the removable plain text display terminal, the graphic display terminal provides contextual troubleshooting and direct access to the appropriate page of the documentation via a dynamic QR code.

#### Power options (line chokes, bypass contactor)

The power options of Altivar Soft Starter ATS480 bring you the possibility to improve the power quality and efficiency of your installation. These options also improve the continuity of service of the installation and its robustness.

# Contents

## Altivar Soft Starter ATS480

**Altivar Soft Starter selection guide** ..... page 4

■ **General presentation**..... page 6

■ **Altivar Soft Starter presentation**..... page 8

### ■ Selection criteria

□ From an ATS48 commercial reference ..... page 13

□ Selection criteria for Altivar Soft Starter ATS480 ..... page 13

□ Normal and heavy duty applications ..... page 14

□ Selection of ATS480 commercial reference ..... page 15

□ Special uses ..... page 16

### ■ Soft starter references

□ Connection in-line, not bypassed, motor power in kW..... page 18

□ Connection inside delta, not bypassed, motor power in kW ..... page 19

□ Connection in-line, not bypassed, motor power in HP ..... page 20

□ Replacement parts ..... page 21

### ■ Configuration and runtime tools

□ Plain text display terminal and accessories..... page 22

□ Graphic display terminal and accessories..... page 24

□ DTM and SoMove software ..... page 26

### ■ Options

□ Soft starter/option combinations ..... page 27

□ Communication buses and networks ..... page 28

□ Line chokes ..... page 32

□ DNV kits and protective covers ..... page 33

■ **Firmware update**..... page 34

### ■ Motor starter combinations

□ Presentation ..... page 35

□ Type 1 coordination ..... page 36

□ Type 2 coordination ..... page 40

□ Line contactor reference table ..... page 44

### ■ Dimensions

□ Soft starters ..... page 45

□ Line chokes ..... page 46

## Field services

■ **A whole world of services by Schneider Electric**..... page 47

## Index

■ **Product reference index**..... page 49

Schneider Electric's IoT-enabled, plug-and-play, open, secure, interoperable architecture and platform, in Industries, Infrastructures, Data Centers, and Buildings.

**Innovation at every level**

EcoStruxure is based on a three-tiered technology stack delivering innovation at every level, from connected products to edge control and apps, analytics, and services.

Together with our hybrid segments approach, this enhances your value around safety, reliability, operational efficiency, sustainability, and connectivity across 6 domains of expertise:

- Power
- IT
- Building
- Plant
- Grid
- Machine

**Dedicated architectures and IoT**

We tailor our solutions in the form of dedicated reference architectures for plants:

- Management systems
- Power systems
- Data center systems
- Industrial plant and machine systems
- Smart grid systems

The Industrial Internet of Things (IIoT) gives an additional boost to technologies. That's why we provide our customers with an IoT-enabled architecture and platform offering simple, reliable, productive, and cost-efficient solutions.

**Cybersecurity solutions**

Robust cybersecurity protection is a must, and Schneider Electric's solutions can deliver it, regardless of business type or industry.

The vendor-agnostic services provided by our skilled professionals help to protect your entire critical infrastructure. We help to assess your risk, implement cyber-specific solutions, and maintain your onsite defenses over time, while integrating appropriate IT policies and requirements.

This is our difference and your advantage.

**Enhanced safety**

With the release of M580 Safety, Schneider Electric further expands the EcoStruxure platform.

This consolidates our position as one of the most trusted industrial safety vendor, with thousands of Modicon and Triconex safety systems protecting the most critical industrial processes globally.





**EcoStruxure™ for Industry**  
Innovation At Every Level



\*The Schneider Electric industrial software business and AVEVA have merged to trade as AVEVA Group plc, a UK listed company. The Schneider Electric and Life is On trademarks are owned by Schneider Electric and are being licensed to AVEVA by Schneider Electric.

# Altivar Soft Starter ATS480

Soft starters for asynchronous motors  
Altivar Soft Starter ranges

Market segments	Simple machines		Industrial machines		Process and infrastructures, demanding machines
Applications	Simple starting	Simple starting and stopping	Simple starting and stopping for pumps and fans		Controlled starting and stopping for pumps, fans, compressors, mixers, crushers, conveyors
					
<b>Operational voltage range Ue (V)</b>	110...480	200...480	230...440	208...600	208...690
<b>Operational current range Ie (A)</b>	3...25	6...32	17...590	17...590	17...1200
<b>Power range</b>	<b>For 50...60Hz line supply (kW/HP)</b>				
Single-phase 110...230 V (kW)	0.37...2.2	–	–	–	–
Three-phase 200...240 V (kW/HP)	–	0.75...7.5/1...10	–	–	–
Three-phase 200...480 V (kW/HP)	0.37...11/0.5...15	–	–	–	–
Three-phase 208 V (HP)	–	–	–	3...150	3...400
Three-phase 230...240 V (kW/HP)	–	–	4...160/–	4...160/5...200	4...355/5...450
Three-phase 380...440 V (kW)	1.1...11	1.5...15	7.5...355	7.5...355	7.5...710
Three-phase 460...480 V (HP)	0.5...15	2...20	–	10...400	10...1000
Three-phase 500...525 V (kW)	–	–	–	9...400	9...800
Three-phase 575 V (HP)	–	–	–	15...500	15...1200
Three-phase 660...690 V (kW)	–	–	–	–	11...900
<b>Motor control</b>	–		Normal duty		Normal duty and heavy duty
Operating cycle	–		350% current rating		500% current rating (700% rated motor current)
Current limiting	–		Yes		Yes
Boost	–		Configurable voltage ramp		Torque control (TCS = torque control system), voltage control
Type of control	Configurable voltage ramp		Configurable voltage ramp		Torque ramp
Deceleration	Voltage ramp		Voltage ramp		Yes
Braking	–	–	–	–	Yes
Number of controlled phases	1	2	3	3	3
Connection inside the delta	–	–	Yes	–	Yes
Bypass	Integrated		Integrated		External with soft starter optimization or without bypass
<b>Functions</b>	External		Electronic embedded, or with PTC		Electronic embedded, with PTC, or with PT100 2- or 3-wire probes
Thermal protections	–		Underload, overload, motor phase loss, line phase inversion, excessive acceleration time, current overload, ground leakage		Underload, overload, motor phase loss, line phase inversion, overcurrent, excessive acceleration time, current overload, ground leakage
Other protections	–		–		Yes
Pre-heating	–		–		Yes
Smoke extraction	–		–		Yes
Multi-motor cascade	–		–		Yes
Second motor set	–		Yes		Yes
<b>Communication</b>	–		Modbus serial link		Modbus serial link
Embedded	–		–		Modbus TCP, EtherNet/IP, PROFINET, PROFIBUS DP V1, CANopen daisy chain, SUB-D, and screw terminal block
Option modules	–		–		Plain text display terminal, graphic display terminal (option), DTM (device type manager), SoMove software
<b>Communication and runtime tools</b>	2 potentiometers	3 potentiometers	7-segment display, SoMove software		PTC or PT100 2- or 3-wire probe
<b>Number of I/O</b>	–		1 PTC probe		4
Analog inputs	–		3		1
Digital inputs	–		–		2
Analog outputs	–		–		3
Digital outputs	1		–		–
Relay outputs	1		2		–
<b>Standards and certifications</b>	IEC/EN 60947-4-2 CE, UL, CSA, C-Tick, and CCC		IEC/EN 60947-4-2, EMC class A CE, UL, CSA, C-Tick, GOST, CCC		IEC/EN 60947-4-2, EMC class A and B CE, cULus, UKCA, CCC, RCM, EAC, DNV, ABS, BV, CCS, REACH, RoHs
<b>References</b>	<b>ATS01N1</b> ●●●●	<b>ATS01N2</b> ●●●●	<b>ATS22</b> ●●●●Q	<b>ATS22</b> ●●●●S6●	<b>ATS480</b> ●●●●Y



# Altivar Soft Starter ATS480

## Soft starters for asynchronous motors

Reduce engineering time, help to secure operations



Altivar Soft Starter ATS480 range

### Enables a secure and digital area

Altivar Soft Starter ATS480 is the new range of soft starters from Schneider Electric designed to digitize the entire life cycle. Powered digitally by EcoStruxure, ATS480 increases efficiency from selection to maintenance.

Altivar Soft Starter ATS480 had been designed to:

- Respect cybersecurity requirements and usages according to the IEC 62443 standard
- Meet the requirements of the most stringent applications in normal and heavy duty
- Cover the operational voltage range from 208 to 690 V in a single product range up to 1200 A

### Extending the service life of ATS48 equipment

#### Easy replacement of ATS48 by ATS480

- > Same footprint and fixings
- > Same I/O
- > Same parameters
- > Same application behavior
- > Keep the same devices, such as circuit breaker and contactors
- > Transfer an ATS48 configuration to the ATS480 using SoMove Converter

#### Make way for evolution

- > Connection to the main fieldbuses on the market
  - Modbus TCP
  - EtherNet/IP
  - CANopen
  - PROFINET
  - PROFIBUS DP
  - Modbus serial
- > Firmware update of the product and options
  - Single update: point-to-point
  - Mass update: multi-point
- > Reinforced robustness
  - Conformal coating of printed circuit board
  - Compliance with IEC/EN 60721-3-3 Class 3C3
  - Combination with TeSys Deca and Giga

### Reducing engineering time and cost

With EcoStruxure tools, integrated automation system, and ATS480 Device Type Manager, the engineering time is drastically reduced all along the process from selection to project execution.

- > It takes just two minutes to select the complete soft starter solution with EcoStruxure Motor Control Configurator: no need to be an expert
- > Optimization of the power architecture with EcoStruxure Motor Management Design
  - Analysis of different solutions
  - Selection of the preferred devices according to the architecture
- > Definition of the architecture and detailed design with EcoStruxure Plant Builder including the Bill of Material and quotation
- > With ATS480 DTM, associated derived function block (DFB), and faceplate:
  - Quickly write the PLC program in EcoStruxure Control Expert
  - Integrate ready-to-use faceplate in AVEVA System Platform
  - Adapt and modify parameters without stopping the installation
  - Set, monitor, and diagnose from the engineering station
  - DFB and faceplate available in General Purpose libraries
- > Mass firmware update with EcoStruxure Automation Device Maintenance



**EcoStruxure™**  
Innovation At Every Level

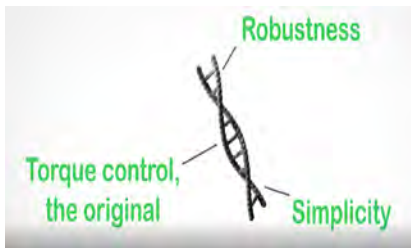

## Helping to secure operations

### The worthy successor of ATS48

Altivar Soft Starter ATS480 has inherited the best of ATS48 recognized and proven attributes:

- > Torque control, the original: Pioneer of the torque control system (TCS), the Schneider Electric algorithm has been copied by major manufacturers but is still at the leading edge
- > Robustness: In terms of starting capabilities, even in the most demanding applications
- > Simplicity: Just set a few parameters displayed in plain text in your language and you are ready to start
- > Asset monitoring:
  - Monitoring of the motor with internal electronic thermal relay, PTC, or PT100 probe
  - Monitoring of the mechanics and hydraulics with control of acceleration and deceleration
  - Monitoring of the main supply and others loads connected by reducing the voltage drop during starting

### Increased continuity of service

- > Bypass according to AC3 for full back-up solution
- > No downtime in case of contactor failure: ATS480 thyristors are able to supply the motor during the start and stop phase, but also during steady state operations at the rated speed
- > Fast replacement of standard contactor by maintenance technician: no need for complete disassembly of the soft starter to replace an internal contactor

### Cybersecurity best practices

- > User account management that includes user authentication, authorization according to the access channels, and strong passwords
- > Hardening to restrict ports, functions, or services
- > Threat intelligence to manage cybersecurity-related events
- > Cybersecurity-compliant firmware upgrade

### Embedded troubleshooting and digital support

- > Easy root cause identification of warnings and detected errors
- > Embedded test routine when connected inside motor delta
- > Direct access to error page of documentation thanks to dynamic QR code
- > QR code to documentation on the front of the ATS480

## Superior sustainability

Altivar Soft Starter ATS480 is a Green Premium product designed to take account of environmental considerations. With the Schneider Electric Green Premium ecolabel, ATS480 meets the following requirements:

- > Use of hazardous substances
  - Compliance with the European RoHS directive (2011/65/EU and 2015/863/EU) and RoHS China
  - Compliance with REACH regulation No.1907/2006 for the declaration of substances of very high concern (SVHC), authorization (Annex XIV), and restriction (Annex XVII)
  - In terms of restrictions, Green Premium goes beyond current directives and regulations
- > Environmental impact  
The Product Environmental Profile (PEP) is a quantitative Type III Environmental Declaration in compliance with ISO 14025 that ensures appropriate reliability and transparency. Based on a Life Cycle Assessment (LCA) of the product along its whole life cycle, the document presents the different impacts such as energy consumption, carbon footprint, consumption of raw materials, and pollution of air, water, and soil.
- > End-of-Life management  
The "ATS480 End-of-life" information document in accordance with IEC 62635 guidance contains the instructions for a responsible disposal of the products and maximizes recycling in a step towards a more circular economy, improving operational efficiency and reducing environmental hazards.
- > Upgradeability  
Altivar Soft Starter ATS480 can be upgraded with additional power options or firmware.

# Altivar Soft Starter ATS480

## Soft starters for asynchronous motors

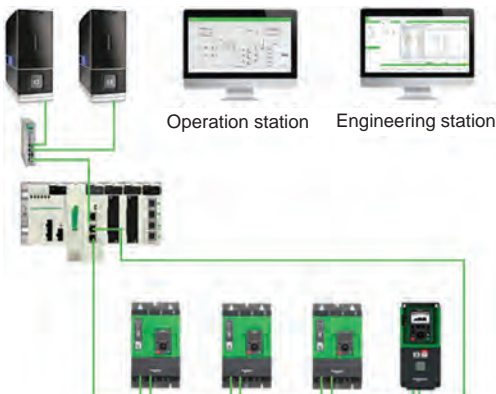

### Process, infrastructures, and industrial machines

Altivar Soft Starter ATS480 is specifically designed to meet the requirements of the following market segments:

- Water and wastewater
- Oil and gas
- Mining, minerals, and metals
- Food and beverage
- Marine

ATS480 also meets the needs of industrial machines.

The Altivar Soft Starter ATS480 range increases availability, helps to ensure continuous operations, and reduces downtime thanks to its:

- Torque control
- Simplicity
- Connectivity
- Communication services
- Robustness

### Applications

The Altivar Soft Starter ATS480 helps to secure soft starting and stopping even for the most demanding applications, while reducing mechanical wear and fluid shocks in hydraulic applications.

ATS480 features include:

- Sized for normal duty and heavy duty applications
- Controlled acceleration thanks to TCS, the original torque control system
- Controlled deceleration thanks to TCS, the original torque control system
- Efficient dynamic braking and DC injection down to zero speed to stop large inertia application
- Up to 700% motor current starting without tripping
- Boost function to override locked shaft, friction
- Smoke extraction
- Cascade

### EcoStruxure Plant integration

The association of Altivar Soft Starter ATS480 with Schneider Electric automation control systems like EcoStruxure Process Expert (for hybrid systems) offers a high-performance, global automation and motor control solution with optimized total cost of ownership (TCO).

The solution provides operational integrity for people, processes, and assets, with improved maintenance support to help reduce downtime and ensure operation continuity.

It offers operational insight by accessing more information to optimize the process. Based on market standards (FDT/DTM, Ethernet, etc.), it is a sustainable, scalable solution that enables processes to be adapted easily and affordably.

An integrated automation system powered by EcoStruxure offers the following benefits:

- More efficient projects
- Optimized operations

# Altivar Soft Starter ATS480

## Soft starters for asynchronous motors



### The offer

The Altivar Soft Starter ATS480 is a controller with six thyristors using the TCS (torque control system) algorithm to control acceleration, deceleration, and stopping of three-phase squirrel cage asynchronous motors up to 900 kW.

- The ATS480 is a cost-effective solution designed to:
  - Reduce machine operating costs by reducing mechanical stress and improving machine availability
  - Reduce the risk of severe damage by reducing fluid shocks and improving installation availability
  - Reduce the stress on the electrical distribution system by reducing line current peaks and voltage drops during motor starts

Altivar Soft Starter ATS480 consists of one range only covering:

- Operational voltage from 208 to 690 V
- Operational current from 17 to 1200 A

ATS480 integrates Modbus serial line communication protocols as standard. Each device is equipped with two RJ45 ports for:

- Connection to configuration and firmware update software
- Connection of the plain text display terminal or graphic display terminal
- Connection to a Modbus fieldbus

In addition, the ATS480 is equipped with one slot for a communication module: Modbus TCP, EtherNet/IP, CANopen, PROFINET, or PROFIBUS DP.

### Robust

The Altivar Soft Starter ATS480 is designed to adapt to the harshest environments.

- Ambient operating temperature:
  - -10...+40 °C/+14...104 °F without derating, up to 60 °C/140 °F with derating of 2% per °C above 40 °C/104 °F
  - -10...+50 °C/+14...122 °F without derating when bypassed, up to 60 °C/140 °F with derating of 2% per °C above 50 °C/122 °F
- Relative humidity without condensing: 5...95%
- Storage and transport temperature: -40...+70 °C/-40...+158 °F
- Withstand to harsh environments:
  - Chemical class 3C3 conforming to IEC/EN 60721-3-3
  - Mechanical class 3S3 conforming to IEC/EN 60721-3-3
  - Printed circuit boards with protective coating
- Operating altitude:
  - 0...1,000 m/0...3,281 ft without derating
  - 1,000...4,000 m/3,281...13,124 ft with derating of 1% per 100 m/328 ft
  - Altitude also has an impact on the overvoltage category of the supply source (see "System earthing arrangement and mains voltage" section below)

### System earthing arrangement and mains voltage

To comply with IEC 60947-1, the system earthing arrangement, mains voltage used on the ATS480, and the altitude define the overvoltage category of the supply source.

Mains voltage	System earthing arrangement	Supply source overvoltage category required according to altitude	
		Up to 2,000 m/6,562 ft	From 2,000 m/6,562 ft to 4,000 m/13,124 ft
208...480 V	TT or TN	OVCIII	OVCIII
	IT or corner grounded	OVCIII	OVCII
480...600 V	TT or TN	OVCIII	OVCII
	IT or corner grounded	OVCIII	OVCII
600...690 V	TT or TN	OVCIII	OVCII
	IT or corner grounded	OVCII	-

The supply source overvoltage category could be reduced by using an appropriate system such an insulation transformer.

# Altivar Soft Starter ATS480

## Soft starters for asynchronous motors



Altivar Soft Starter ATS480 equipped with optional protective covers

### The offer (continued)

#### Installation

ATS480 is intended to be mounted in a cabinet. The protection rating of the products is as follows:

- IP20 for current rating from 17 to 110 A
- IP00 for current rating from 140 to 1200 A

The units from 140 to 1200 A have unprotected power terminals. For units from 140 to 660 A, these terminals can be fitted with protective covers (see [page 33](#)). The protective covers are to be used with eyelet connections.

#### Electromagnetic compatibility (EMC)

Compliance with electromagnetic compatibility requirements has been incorporated into the design of the Altivar Soft Starter ATS480 to ensure equipment meets  $\text{CE}$  marking requirements.

Radiated and conducted emissions according to:

- IEC 60947-4-2 class A on all ATS480 ratings
- IEC 60947-4-2 class B from 17 to 170 A ratings (ATS480 must be bypassed at the end of starting)

#### Certifications

The Altivar Soft Starter ATS480 range has the following certifications: cULus,  $\text{CE}$ , UKCA, CCC, RCM, EAC, DNV, ABS, BV, CCS, REACH, RoHs Europe, RoHs China, PEP ecopassport

Marking:  $\text{CE}$ , cULus, CCC, EAC, RCM, UKCA, Green Premium

#### Integrated functions

The Altivar Soft Starter ATS480 includes numerous functions related to monitoring, the application, and start/stop performance, including:

- TCS, the original torque control system: constant control of the torque supplied to the motor during acceleration and deceleration phases (significantly reducing pressure surges)
- Dynamic braking
- Bypassing the soft starter using a contactor at the end of the starting phase whilst maintaining electronic monitoring (bypass function)
- Wide frequency tolerance for generator set power supplies
- Connecting the soft starter inside the motor delta

#### Application monitoring

- Built-in motor thermal monitoring
- Connection of PTC probes
- Connection of PT100 probes
- Monitoring of the time before restart
- Phase rotation
- Phase loss
- Mains loss
- Excessive starting time locked rotor

#### Application functions

- Monitoring of underloads and overcurrents during continuous operation
- Smoke extraction
- Main phase inversion
- Boost
- Torque limitation
- Second set of motor parameters
- Motor preheating function
- Warnings
- Forced local mode
- Automatic restart
- Cascade



Modbus serial link and slot for the communication module



Graphic display terminal  
VW3A1111



SoMove software

### Integration

#### Fieldbus protocol

- Modbus serial link (embedded) **1**
  - Standard Modbus
  - Connection of configuration and runtime tools
  - Control of the Altivar Soft Starter ATS480 in automation architectures (PLCs, IPCs, HMIs, etc.) in industrial network protocols for reading/writing data:
    - Diagnostics, supervision, and fieldbus management functions
- The following communication modules are available as an option **2**:
- Modbus TCP, EtherNet/IP and its services
  - SNMP, SNTP, BOOTP & DHCP, IP V6, cybersecurity services, FDR
  - Open Ethernet topologies
  - Embedded WebServer
- PROFINET
- CANopen
- PROFIBUS DP

#### Integration of configuration and runtime tool

- FDT/DTM technology within EcoStruxure Control Expert (see [page 26](#))
  - ATS480 configuration
  - Diagnostics
  - Control
  - Monitoring

#### Dialog and configuration tools

- Display terminal
  - Plain text display terminal delivered as standard mounted on product front face (can be door mounted with IP43 degree of protection using an accessory) for:
    - ATS480 control, adjustment, and configuration
    - Display of current values (motor, I/O, etc.)
    - Diagnostics
    - Configuration storage and download
    - Duplication of the configuration in ATS480
  - Graphic display terminal as separate option for product front face mounting or IP65 door mounting used for:
    - Duplication of an ATS480 configuration of one powered-up ATS480 on another powered-up ATS480
    - Copying configurations from a PC or ATS480 in the graphic display terminal and duplicating them on other ATS480 (the soft starter must be powered on for the duration of the duplication operations)
    - Connection to several drives using multidrop link components
    - ATS480 control, adjustment, and configuration
    - Diagnostics
    - Display of current values (motor, I/O, etc.)
    - Configuration storage and download
    - Access to digital portal via dynamic QR code
- Web server with Modbus TCP, EtherNet/IP communication module
  - Easily accessible from any PC, iPhone, iPad, Android system, and major web browsers through the WIFER (Wifi dongle)
  - Network diagnostics in real time
  - Read/write values
- SoMove software
  - Advanced functions for configuration, setup, and maintenance of Altivar Soft Starter ATS480



Cybersecurity for your assets

### Cybersecurity

Cybersecurity best practices embedded in Altivar Soft Starter ATS480 help to protect the installation against casual or coincidental violations coming from insiders such as well-intentioned and careless employees or contractors with no cybersecurity attack skills: this represents 60% of cyberattacks.

Cybersecurity features help to:

- Enforce authorization of users through:
  - User authentication
  - Administrator override capability for user authorizations
  - Strong passwords
  - Passwords encrypted in a non-reversible way
  - Authorization managed according to channels
- Restrict and disable functions or services:
  - Sign-in required after a configurable period of inactivity
  - Prohibited or restricted use of ports, protocols
  - Enabled/disabled services: e.g. SNMP service
- Generate security-related reports:
  - Cybersecurity events recorded in dedicated database
  - Reports include user's name, type of operation, time stamp
  - Warning when storage capacity is approaching
  - Storage capacity up to 500 logins
  - 10 years' battery lifetime, warning when low battery is approaching
- Protect authenticity of the firmware through:
  - Digitally-signed firmware
  - Cryptographic firmware keys
  - Original firmware stored in secure location
  - Ensuring that valid firmware is used at each power-up

The cybersecurity settings can be exported as an individual file to be saved and shared with different devices.



Scanning the QR code from a smartphone or tablet

### Services

Altivar Soft Starter ATS480 features integrated services to achieve optimum time savings:

- Native simplicity to set-up and start
- Simplified communication with Modbus TCP, EtherNET/IP communication module: Ethernet port with embedded web server
- Cybersecurity-compliant firmware update:
  - Firmware version available on se.com from Altivar Soft Starter ATS480 web page
  - Single device firmware update using SoMove
  - Mass firmware deployment using EcoStruxure Automation Device Maintenance
  - Applying the new firmware can be automatic or on order
  - Firmware update is available on ATS480 products, communication modules, and display terminal languages
- Three QR codes:
  - Access to the digital customer portal: product data sheet, ATS480 ID card, Customer Care Center application
  - Direct access to description of the functions with optional graphic display
  - QR code generated in the event of a detected error (red screen) with optional graphic display terminal: identification of the detected error, probable causes, and remedies

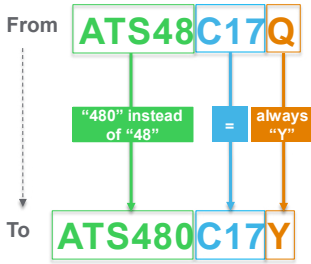

### From an ATS48 commercial reference

ATS48 and ATS480 have the same commercial reference structure:

- The product range e.g. ATS48
- The current rating e.g. C17
- The voltage e.g. Q (Q for 230/415 V or Y for 208/690 V)

To select the ATS480 commercial reference corresponding to the ATS48 reference:

- 1 – Replace the ATS48 product range with ATS480
- 2 – Keep the same rating
- 3 – Always put Y to represent the operational voltage

Examples:

- ATS48M12Q becomes ATS480M12Y
- ATS48D62Y becomes ATS480D62Y

**Note:** ATS48 and ATS480 control supply voltage may differ, check the value in the installation guide before starting the system.

### Selection criteria for Altivar Soft Starter ATS480

- The mains voltage
- The rated motor power and rated motor current
- The type of application: normal duty or heavy duty

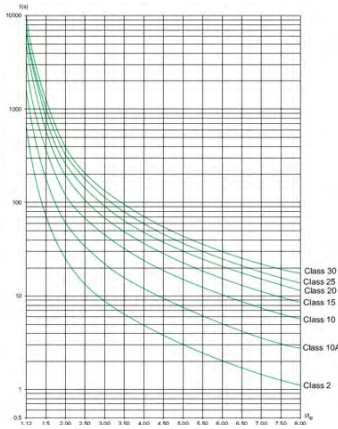

Motor thermal protection curves (from cold state)

### Select normal duty or heavy duty application

Examples of normal duty and heavy duty applications are given on [page 14](#).

Normal duty and heavy duty are differentiated by the required overload that is defined by the following:

- Service duty: continuous or intermittent
- Service factor
- Overcurrent value
- Overcurrent duration

From an application standpoint, the overload is defined depending on the service duty of the motor - S1 (continuous operation) or S4 (intermittent operation) - according to the following table:

Service type	Overload (starting)		Service cycle	
	Overcurrent	Duration	No. of starts/h	Conduction
<b>Normal duty</b>				
S1	4 x I <sub>n</sub> 3 x I <sub>n</sub>	23 s 46 s	Continuous operations after starting	
S4	4 x I <sub>n</sub> 3 x I <sub>n</sub>	12 s 23 s	10	50%
<b>Heavy duty</b>				
S1	4 x I <sub>n</sub> 3 x I <sub>n</sub>	48 s 90 s	Continuous operations after starting	
S4	4 x I <sub>n</sub>	25 s	5	50%



Motor service duty S1

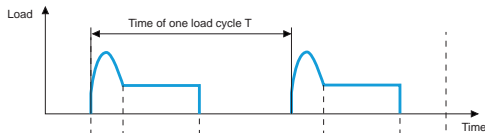

Motor service duty S4

Each application duty has a corresponding motor protection class:

- Normal duty -> motor thermal protection class 10E
- Heavy duty -> motor thermal protection class 20E



**Normal and heavy duty applications**

Depending on the type of machine, the applications are categorized as normal duty or heavy duty based on the starting characteristics, which are given as examples only in the table below.

Type of machine	Application	Functions performed by the Altivar Soft Starter ATS480	Starting current (% In)	Starting time (s)
Centrifugal pump	Normal duty	Deceleration (reduction in pressure surges) Detection of underload or reversal of phase rotation direction	300	5 to 15
Piston pump	Normal duty	Control of pump priming and direction of rotation	350	5 to 10
Fan	Normal duty Heavy duty if > 30 s	Detection of overloads caused by clogging or underloads (motor/fan transmission broken) Braking torque on stopping	300	10 to 40
Cold compressor	Normal duty	Monitoring, even for special motors	300	5 to 10
Screw compressor	Normal duty	Detection of reversal of phase rotation direction Contact for automatic draining on stopping	300	3 to 20
Centrifugal compressor	Normal duty Heavy duty if > 30 s	Detection of reversal of phase rotation direction Contact for automatic draining on stopping	350	10 to 40
Piston compressor	Normal duty	Detection of reversal of phase rotation direction Contact for automatic draining on stopping	350	5 to 10
Conveyor, transporter	Normal duty	Monitoring of overloads for incident detection or underloads for break detection	300	3 to 10
Lifting screw	Normal duty	Monitoring of overloads for hard spot detection or underloads for break detection	300	3 to 10
Drag lift	Normal duty	Monitoring of overloads for jamming detection or underloads for break detection	400	2 to 10
Lift	Normal duty	Monitoring of overloads for jamming detection or underloads for break detection Constant starting with variable load	350	5 to 10
Circular saw, band saw	Normal duty Heavy duty if > 30 s	Braking for fast stop	300	10 to 60
Pulper, butchery cutter	Heavy duty	Torque control on starting	400	3 to 10
Agitator	Normal duty	The current display indicates the density of the material	350	5 to 20
Mixer	Normal duty	The current display indicates the density of the material	350	5 to 10
Grinder	Heavy duty	Braking to limit vibrations during stopping, monitoring of overloads for jamming detection	450	5 to 60
Crusher	Heavy duty	Braking to limit vibrations during stopping, monitoring of overloads for jamming detection	400	10 to 40
Refiner	Normal duty	Torque control on starting and stopping	300	5 to 30
Press	Heavy duty	Braking to increase the number of cycles	400	20 to 60

# Altivar Soft Starter ATS480

## Soft starters for asynchronous motors

### Selection of ATS480 commercial reference

#### Selection of ATS480 commercial reference

Once the appropriate application has been selected from the previous page, select the Altivar Soft Starter ATS480 from [page 18](#) according to the supply voltage and the motor power. Check that the rated motor current is lower than the operational current of the ATS480.

The Altivar Soft Starter ATS480 is designed to respect the operations shown in the table in the "Select normal duty or heavy duty application" section on [page 13](#) without triggering an overheat error and without bypass at 40 °C/104 °F max. and at an altitude of 1,000 m/3,280 ft. Above those limits it is necessary to derate the operational current of the soft starter as follows:

- derating of 2% per °C above 40 °C/104 °F up to 60 °C/140 °F
- derating of 1% per 100 m/328 ft up to 4,000 m/13,124 ft

Breakdown of ATS480 product reference

	ATS	480	D	32	Y
<b>Product range</b>	Altivar Soft Starter				
<b>Type</b>	480				
<b>Factor for current rating</b>	D Current x 1 C Current x 10 M Current x 100				
<b>Current multiplicand</b>	10-11-12-.....66-75-79-88				
<b>Mains voltage</b>	Y 208 to 690 VAC ;				

For example, for the reference ATS480C17Y, the current rating is 170 A (17 x 10). The current rating is defined as the rated operational current in normal duty, in-line, not bypassed at 40 °C/104 °F.

#### Optimizing the selection when bypassed

When bypassed, the Altivar Soft Starter ATS480 rating selection can be optimized. The thyristors were chosen not only to supply the motor during starting and stopping but also during steady state operations. However, the soft starter can be bypassed by a contactor at the end of starting (to limit the heat dissipated by the soft starter). The bypass contactor is controlled by the soft starter: the current measurements and monitoring mechanisms remain active when the soft starter is bypassed.

When bypassed, the ATS480 can supply a higher power motor.

Example of an 11 kW motor at 400 V:

- In normal duty:
  - Select ATS480D22Y if not bypassed
  - Select ATS480D17Y if bypassed and check that the current limiting is in accordance with the starting requirement
- In heavy duty:
  - Select ATS480D32Y if not bypassed
  - Select ATS480D22Y if bypassed and check that the current limiting is in accordance with the starting requirement

#### Special uses

Other use cases that influence the selection of the Altivar Soft Starter ATS480:

#### Connection inside the delta of the motor

In addition to the most frequently encountered wiring layouts, where the soft starter is installed in the line supply of the motor and the motor is connected in star or delta configuration, the ATS480 can be wired to the motor delta terminal in series with each winding (see the application diagram below). The soft starter current is lower than the line current absorbed by the motor by a ratio of  $\sqrt{3}$ . This type of installation enables a soft starter with a lower rating to be used.

Example: For a 400 V/110 kW motor with a line current of 195 A (current indicated on the motor nameplate for the delta connection), the current in each winding is equal to  $195/\sqrt{3}$ , i.e. 114 A.

Select the soft starter rating with a maximum permanent rated current just above this current, i.e. 140 A (ATS 48C14Y for a normal duty application).

If bypassed, ATS480C11Y can be used provided that the current limiting is in accordance with the starting requirement.

To avoid making this calculation, simply use the table on [page 18](#).

This type of installation only permits freewheel stopping and is not compatible with the cascade and preheating functions.

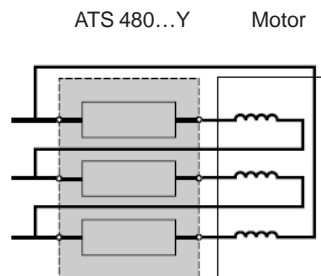

Soft starter wired in series with the motor windings.

Note: The rated current and current limiting settings as well as the current displayed during operation are on-line values (so do not have to be calculated by the user).

For this type of installation, observe the wiring scheme and the associated recommendations on [page 35](#).

#### Motors in parallel

Motors may be connected in parallel provided that the power limit of the soft starter is not exceeded (the sum of the motor currents must not exceed the rated current of the soft starter selected depending on the type of application). Install an external overload relay for each motor.

#### Brush motor

The Altivar Soft Starter ATS480 can operate with a bypassed rotor resistance motor or with a resistance lug. The starting torque is modified in accordance with the rotor resistance. If necessary, maintain a low resistance in the rotor winding to obtain the required torque to overcome the resistive torque on starting.

A bypassed brush motor has a very low starting torque. A high stator current is required to obtain the sufficient starting torque.

Oversize the soft starter so that the current limiting value is seven times that of the rated current.

Note: Check that the motor starting torque, equal to seven times the rated current, is greater than the resistive torque.

Note: The ATS480 torque control enables excellent soft starting despite the current limit being seven times the rated current required to start the motor.

## Special uses (continued)

### Dahlander motor and 2-speed motor

The ATS480 can operate with a 2-speed motor. A motor demagnetization period must elapse before changing from low speed to high speed in order to avoid antiphases between the mains supply and the motor, which would generate very high currents.

The ATS480 can save two sets of motor parameters that can be selected to optimize start/stop at both speeds.

Select the soft starter using the three main criteria.

### Very long motor cable

Very long motor cables cause voltage drops due to the resistance of the cable. If the voltage drop is significant, it could affect the current consumption and the torque available. This must therefore be taken into account when selecting the motor and the soft starter.

### Soft starters in parallel on the same line supply

If several soft starters are installed on the same line supply, line chokes should be installed between the transformer and the soft starter (see [page 32](#)).

### Restricted use

Do not use the Altivar Soft Starter ATS480 upstream of loads other than motors (for example, transformers and resistors are not allowed).

Do not connect power factor correction capacitors to the terminals of a motor controlled by an Altivar Soft Starter ATS480.

# Altivar Soft Starter ATS480

Soft starters for asynchronous motors

Connection in-line, not bypassed

Motor power in kW

ATS480 in-line, not bypassed										
Motor nameplate							ATS480			
Rated operational voltage (Ue) Rated motor power							Reference	Operational rated current (Ie)	Power dissipated at Ie	Weight
230 V	400 V	440 V	500 V	525 V	660 V	690 V				
kW	kW	kW	kW	kW	kW	kW				
<b>Normal duty applications</b>										
4	7.5	7.5	9	9	11	15	<a href="#">ATS480D17Y</a>	17	38	4.900/10.8
5.5	11	11	11	11	15	18.5	<a href="#">ATS480D22Y</a>	22	54	4.900/10.8
7.5	15	15	18.5	18.5	22	22	<a href="#">ATS480D32Y</a>	32	84	4.900/10.8
9	18.5	18.5	22	22	30	30	<a href="#">ATS480D38Y</a>	38	96	4.900/10.8
11	22	22	30	30	37	37	<a href="#">ATS480D47Y</a>	47	122	4.900/10.8
15	30	30	37	37	45	45	<a href="#">ATS480D62Y</a>	62	181	8.300/18.2
18.5	37	37	45	45	55	55	<a href="#">ATS480D75Y</a>	75	225	8.300/18.2
22	45	45	55	55	75	75	<a href="#">ATS480D88Y</a>	88	270	8.300/18.2
30	55	55	75	75	90	90	<a href="#">ATS480C11Y</a>	110	302	8.300/18.2
37	75	75	90	90	110	110	<a href="#">ATS480C14Y</a>	140	366	12.4/27.3
45	90	90	110	110	132	160	<a href="#">ATS480C17Y</a>	170	459	12.4/27.3
55	110	110	132	132	160	200	<a href="#">ATS480C21Y</a>	210	560	18.2/40.1
75	132	132	160	160	220	250	<a href="#">ATS480C25Y</a>	250	675	18.2/40.1
90	160	160	220	220	250	315	<a href="#">ATS480C32Y</a>	320	882	18.2/40.1
110	220	220	250	250	355	400	<a href="#">ATS480C41Y</a>	410	1319	51.4/113.3
132	250	250	315	315	400	500	<a href="#">ATS480C48Y</a>	480	1366	51.4/113.3
160	315	355	400	400	560	560	<a href="#">ATS480C59Y</a>	590	1711	51.4/113.3
–	355	400	–	–	630	630	<a href="#">ATS480C66Y</a>	660	1938	51.4/113.3
220	400	500	500	500	710	710	<a href="#">ATS480C79Y</a>	790	2517	115.0/253.5
250	500	630	630	630	900	900	<a href="#">ATS480M10Y</a>	1000	2845	115.0/253.5
355	630	710	800	800	–	–	<a href="#">ATS480M12Y</a>	1200	3472	115.0/253.5
<b>Heavy duty applications</b>										
3	5.5	5.5	7.5	7.5	9	11	<a href="#">ATS480D17Y</a>	12	26	4.900/10.8
4	7.5	7.5	9	9	11	15	<a href="#">ATS480D22Y</a>	17	39	4.900/10.8
5.5	11	11	11	11	15	18.5	<a href="#">ATS480D32Y</a>	22	54	4.900/10.8
7.5	15	15	18.5	18.5	22	22	<a href="#">ATS480D38Y</a>	32	79	4.900/10.8
9	18.5	18.5	22	22	30	30	<a href="#">ATS480D47Y</a>	38	96	4.900/10.8
11	22	22	30	30	37	37	<a href="#">ATS480D62Y</a>	47	133	8.300/18.2
15	30	30	37	37	45	45	<a href="#">ATS480D75Y</a>	62	181	8.300/18.2
18.5	37	37	45	45	55	55	<a href="#">ATS480D88Y</a>	75	225	8.300/18.2
22	45	45	55	55	75	75	<a href="#">ATS480C11Y</a>	88	232	8.300/18.2
30	55	55	75	75	90	90	<a href="#">ATS480C14Y</a>	110	286	12.4/27.3
37	75	75	90	90	110	110	<a href="#">ATS480C17Y</a>	140	371	12.4/27.3
45	90	90	110	110	132	160	<a href="#">ATS480C21Y</a>	170	448	18.2/40.1
55	110	110	132	132	160	200	<a href="#">ATS480C25Y</a>	210	560	18.2/40.1
75	132	132	160	160	220	250	<a href="#">ATS480C32Y</a>	250	675	18.2/40.1
90	160	160	220	220	250	315	<a href="#">ATS480C41Y</a>	320	997	51.4/113.3
110	220	220	250	250	355	400	<a href="#">ATS480C48Y</a>	410	1152	51.4/113.3
132	250	250	315	315	400	500	<a href="#">ATS480C59Y</a>	480	1366	51.4/113.3
160	315	355	400	400	560	560	<a href="#">ATS480C66Y</a>	590	1711	51.4/113.3
–	355	400	–	–	630	630	<a href="#">ATS480C79Y</a>	660	2053	115.0/253.5
220	400	500	500	500	710	710	<a href="#">ATS480M10Y</a>	790	2205	115.0/253.5
250	500	630	630	630	900	900	<a href="#">ATS480M12Y</a>	1045	2845	115.0/253.5

**Altivar Soft Starter ATS480**

Soft starters for asynchronous motors

Connection inside delta, not bypassed

Motor power in kW

<b>ATS480 inside delta, not bypassed</b>					
Motor nameplate		ATS480			
Rated operational voltage (Ue) Rated motor power		Reference	Operational rated current (Ie)	Power dissipated at le	Weight
230 V	400 V				
kW	kW		A	W	kg/lb
<b>Normal duty applications</b>					
7.5	15	<a href="#">ATS480D17Y</a>	17	38	4.900/10.8
9	18.5	<a href="#">ATS480D22Y</a>	22	54	4.900/10.8
15	22	<a href="#">ATS480D32Y</a>	32	84	4.900/10.8
18.5	30	<a href="#">ATS480D38Y</a>	38	96	4.900/10.8
22	45	<a href="#">ATS480D47Y</a>	47	122	4.900/10.8
30	55	<a href="#">ATS480D62Y</a>	62	181	8.300/18.2
37	55	<a href="#">ATS480D75Y</a>	75	225	8.300/18.2
45	75	<a href="#">ATS480D88Y</a>	88	270	8.300/18.2
55	90	<a href="#">ATS480C11Y</a>	110	302	8.300/18.2
75	110	<a href="#">ATS480C14Y</a>	140	366	12.4/27.3
90	132	<a href="#">ATS480C17Y</a>	170	459	12.4/27.3
110	160	<a href="#">ATS480C21Y</a>	210	560	18.2/40.1
132	220	<a href="#">ATS480C25Y</a>	250	675	18.2/40.1
160	250	<a href="#">ATS480C32Y</a>	320	882	18.2/40.1
220	315	<a href="#">ATS480C41Y</a>	410	1319	51.4/113.3
250	355	<a href="#">ATS480C48Y</a>	480	1366	51.4/113.3
–	400	<a href="#">ATS480C59Y</a>	590	1711	51.4/113.3
315	500	<a href="#">ATS480C66Y</a>	660	1938	51.4/113.3
355	630	<a href="#">ATS480C79Y</a>	790	2517	115.0/253.5
–	710	<a href="#">ATS480M10Y</a>	1000	2845	115.0/253.5
500	–	<a href="#">ATS480M12Y</a>	1200	3472	115.0/253.5
<b>Heavy duty applications</b>					
5.5	11	<a href="#">ATS480D17Y</a>	12	26	4.900/10.8
7.5	15	<a href="#">ATS480D22Y</a>	17	39	4.900/10.8
9	18.5	<a href="#">ATS480D32Y</a>	22	54	4.900/10.8
15	22	<a href="#">ATS480D38Y</a>	32	79	4.900/10.8
18.5	30	<a href="#">ATS480D47Y</a>	38	96	8.300/18.2
22	45	<a href="#">ATS480D62Y</a>	47	133	8.300/18.2
30	55	<a href="#">ATS480D75Y</a>	62	181	8.300/18.2
37	55	<a href="#">ATS480D88Y</a>	75	225	8.300/18.2
45	75	<a href="#">ATS480C11Y</a>	88	232	8.300/18.2
55	90	<a href="#">ATS480C14Y</a>	110	286	12.4/27.3
75	110	<a href="#">ATS480C17Y</a>	140	371	12.4/27.3
90	132	<a href="#">ATS480C21Y</a>	170	448	18.2/40.1
110	160	<a href="#">ATS480C25Y</a>	210	560	18.2/40.1
132	220	<a href="#">ATS480C32Y</a>	250	675	18.2/40.1
160	250	<a href="#">ATS480C41Y</a>	320	997	51.4/113.3
220	315	<a href="#">ATS480C48Y</a>	410	1152	51.4/113.3
250	355	<a href="#">ATS480C59Y</a>	480	1366	51.4/113.3
–	400	<a href="#">ATS480C66Y</a>	590	1711	51.4/113.3
315	500	<a href="#">ATS480C79Y</a>	660	2053	115.0/253.5
355	630	<a href="#">ATS480M10Y</a>	790	2205	115.0/253.5
–	710	<a href="#">ATS480M12Y</a>	1045	2845	115.0/253.5

# Altivar Soft Starter ATS480

Soft starters for asynchronous motors

Connection in-line, not bypassed

Motor power in HP

ATS480 in-line, not bypassed							
Motor nameplate				ATS480			
Rated operational voltage (Ue) Rated motor power				Reference	Operational rated current (Ie)	Power dissipated at Ie	Weight
208 V	230 V	460 V	575 V				
HP	HP	HP	HP	A	W	kg/lb	
<b>Normal duty applications</b>							
3	5	10	15	<a href="#">ATS480D17Y</a>	17	38	4.900/10.8
5	7.5	15	20	<a href="#">ATS480D22Y</a>	22	54	4.900/10.8
7.5	10	20	25	<a href="#">ATS480D32Y</a>	32	84	4.900/10.8
10	–	25	30	<a href="#">ATS480D38Y</a>	38	96	4.900/10.8
–	15	30	40	<a href="#">ATS480D47Y</a>	47	122	4.900/10.8
15	20	40	50	<a href="#">ATS480D62Y</a>	62	181	8.300/18.2
20	25	50	60	<a href="#">ATS480D75Y</a>	75	225	8.300/18.2
25	30	60	75	<a href="#">ATS480D88Y</a>	88	270	8.300/18.2
30	40	75	100	<a href="#">ATS480C11Y</a>	110	302	8.300/18.2
40	50	100	125	<a href="#">ATS480C14Y</a>	140	366	12.4/27.3
50	60	125	150	<a href="#">ATS480C17Y</a>	170	459	12.4/27.3
60	75	150	200	<a href="#">ATS480C21Y</a>	210	560	18.2/40.1
75	100	200	250	<a href="#">ATS480C25Y</a>	250	675	18.2/40.1
100	125	250	300	<a href="#">ATS480C32Y</a>	320	882	18.2/40.1
125	150	300	350	<a href="#">ATS480C41Y</a>	410	1319	51.4/113.3
150	–	350	400	<a href="#">ATS480C48Y</a>	480	1366	51.4/113.3
–	200	400	500	<a href="#">ATS480C59Y</a>	590	1711	51.4/113.3
200	250	500	600	<a href="#">ATS480C66Y</a>	660	1938	51.4/113.3
250	300	600	800	<a href="#">ATS480C79Y</a>	790	2517	115.0/253.5
350	350	800	1000	<a href="#">ATS480M10Y</a>	1000	2845	115.0/253.5
400	450	1000	1200	<a href="#">ATS480M12Y</a>	1200	3472	115.0/253.5
<b>Heavy duty applications</b>							
2	3	7.5	10	<a href="#">ATS480D17Y</a>	12	26	4.900/10.8
3	5	10	15	<a href="#">ATS480D22Y</a>	17	39	4.900/10.8
5	7.5	15	20	<a href="#">ATS480D32Y</a>	22	54	4.900/10.8
7.5	10	20	25	<a href="#">ATS480D38Y</a>	32	79	4.900/10.8
10	–	25	30	<a href="#">ATS480D47Y</a>	38	96	8.300/18.2
–	15	30	40	<a href="#">ATS480D62Y</a>	47	133	8.300/18.2
15	20	40	50	<a href="#">ATS480D75Y</a>	62	181	8.300/18.2
20	25	50	60	<a href="#">ATS480D88Y</a>	75	225	8.300/18.2
25	30	60	75	<a href="#">ATS480C11Y</a>	88	232	8.300/18.2
30	40	75	100	<a href="#">ATS480C14Y</a>	110	286	12.4/27.3
40	50	100	125	<a href="#">ATS480C17Y</a>	140	371	12.4/27.3
50	60	125	150	<a href="#">ATS480C21Y</a>	170	448	18.2/40.1
60	75	150	200	<a href="#">ATS480C25Y</a>	210	560	18.2/40.1
75	100	200	250	<a href="#">ATS480C32Y</a>	250	675	18.2/40.1
100	125	250	300	<a href="#">ATS480C41Y</a>	320	997	51.4/113.3
125	150	300	350	<a href="#">ATS480C48Y</a>	410	1152	51.4/113.3
150	–	350	400	<a href="#">ATS480C59Y</a>	480	1366	51.4/113.3
–	200	400	500	<a href="#">ATS480C66Y</a>	590	1711	51.4/113.3
200	250	500	600	<a href="#">ATS480C79Y</a>	660	2053	115.0/253.5
250	300	600	800	<a href="#">ATS480M10Y</a>	790	2205	115.0/253.5
350	350	800	1000	<a href="#">ATS480M12Y</a>	1045	2845	115.0/253.5

# Altivar Soft Starter ATS480

## Soft starters for asynchronous motors

### Replacement parts

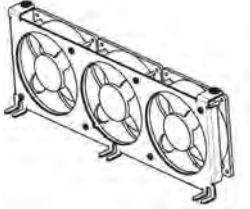

VZ3V485

Replacement parts			
Description	Corresponding soft starter	Reference	Weight
			kg/lb
Fan kit + instruction sheet	ATS480D32Y...D38Y	<a href="#">VZ3V481</a>	0.270/0.595
	ATS480D47Y	<a href="#">VZ3V4811</a>	0.255/0.562
	ATS480D62Y...C11Y	<a href="#">VZ3V482</a>	0.430/0.948
	ATS480C14Y...C17Y	<a href="#">VZ3V483</a>	0.460/1.014
	ATS480C21Y...C32Y	<a href="#">VZ3V484</a>	0.670/1.477
	ATS480C41Y...C66Y	<a href="#">VZ3V485</a>	1.400/3.100
	ATS480C79Y...M12Y (two kits necessary to replace all fans)	<a href="#">VZ3V485</a>	1.400/3.100
	Control terminal strips	All ATS480	<a href="#">VY1G480C01</a>
Control blocks plastic covers	All ATS480	<a href="#">VY1G480M01</a>	0.230/0.507
Control block + instruction sheet	All ATS480	<a href="#">VX4G4801</a>	0.390/0.860



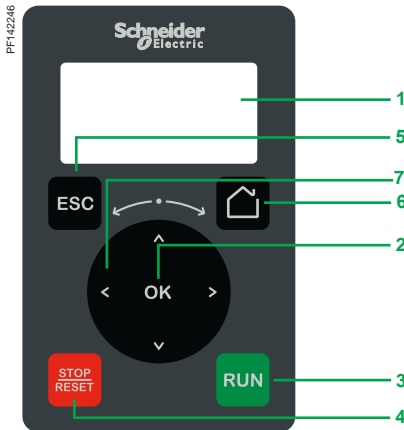

Plain text display terminal

### Plain text display terminal

The plain text display terminal is delivered with Altivar Soft Starter ATS480 and can be:

- Connected and mounted on the front of the soft starter
- Connected and mounted on an enclosure door using a remote-mounting accessory

This terminal is used to:

- Control, adjust, and configure the soft starter
- Display current values (motor, I/O, and machine data)
- Store and download configurations (several configuration files can be stored in the memory)
- Duplicate the configuration of one powered-up soft starter on another powered-up soft starter

Other features:

- Displaying the device - via a web server and password; a display terminal is required to log in to the web server for the first time
- Two lines
- Languages (Chinese, English, French, German, Italian, Spanish)
- White backlit LCD screen
- Operating temperature range: -15...50 °C/+5...122 °F
- IP21 protection
- Removable, easy plug-in with RJ45 port

### Description

The front of the display terminal comprises:

- 1 LCD backlight screen
- 2 OK button: saves the current value (ENT)
- 3 RUN button: local control of motor run command
- 4 STOP/RESET button: local control of motor stop command/clearing detected errors
- 5 ESC button: aborts a value, parameter, or menu to return to the previous selection
- 6 Home: root menu
- 7 Turn ±: navigation dial, increases or decreases the value, goes to the next or previous line

### References

Description	Reference	Weight kg/ lb
Plain text display terminal	VW3A1113	0.200/ 0.441



Remote-mounting kit for mounting plain text display terminal on enclosure door (front panel)



Remote-mounting kit for mounting plain text display terminal on enclosure door (rear panel)

## Mounting kit for plain text display terminal

■ Remote-mounting kit for mounting on an enclosure door with IP43 degree of protection as standard

### Description

The kit includes:

- Tightening tool (also sold separately under the reference ZB5AZ905)
- 1 Mounting plate
- 2 RJ45 port for the plain text display terminal
- 3 Seal
- 4 Fixing nut
- 5 RJ45 port for connecting the remote-mounting cordset

Cordsets should be ordered separately depending on the length required.

Drilling a hole with a standard  $\varnothing 22$  tool, as used for a pushbutton, allows the unit to be mounted without the need for a cut-out in the enclosure ( $\varnothing 22.5$  mm/ $\varnothing 0.89$  in. drill hole).

An anti-rotation function is provided that works as follows: when the kit is locked tightly onto the panel by the nut, the gasket on the back cannot rotate.

### References

Description	Length m/ ft	IP degree of protection	Reference	Weight kg/ lb
<b>Remote-mounting kit</b> Order with remote-mounting cordset VW3A1104R●●●	-	43	<a href="#">VW3A1114</a>	-
<b>Tightening tool</b> For remote-mounting kit	-	-	<a href="#">ZB5AZ905</a>	0.016/ 0.035
<b>Remote-mounting cordset</b> Equipped with two RJ45 connectors	1/ 3.28	-	<a href="#">VW3A1104R10</a>	0.050/ 0.110
	3/ 9.84	-	<a href="#">VW3A1104R30</a>	0.150/ 0.331
	5/ 16.4	-	<a href="#">VW3A1104R50</a>	0.250/ 0.551
	10/ 32.8	-	<a href="#">VW3A1104R100</a>	0.500/ 1.102

### Communication accessory

Description	Reference	Weight kg/ lb
<b>Wi-Fi dongle</b> Portable battery powered Wi-Fi access point for Wi-Fi equipment (PC, tablet, smartphone, etc.)	<a href="#">TCSEGWB131W</a>	0.350/ 0.772



Graphic display terminal VW3A1111



Detected fault: The red screen backlight is activated automatically



Embedded dynamic QR codes for contextual, instantaneous access to online help



Scanning the QR code from a smartphone or tablet



Instant access to online help

## Graphic display terminal

This terminal can be:

- Connected and mounted on an enclosure door using a remote-mounting accessory
- Connected to a PC to exchange files via a Mini USB/USB connection (1)
- Connected to several soft starters and drives in multidrop mode (see page 25)

This terminal is used to:

- Control, adjust, and configure the soft starter
- Display current values (motor, I/O, and machine data)
- Display graphic dashboards such as the energy consumption monitoring dashboard
- Store and download configurations (several configuration files can be stored in the 16 MB memory)
- Duplicate the configuration of one powered-up soft starter on another powered-up soft starter
- Copy configurations from a PC or soft starter and duplicate them on another soft starter (the soft starters should be powered up throughout the duplication operations)

Other characteristics:

- Up to 24 languages (complete alphabets) covering the majority of countries around the world (languages can be removed, added, and updated according to user needs; please consult our website)
- Two-color backlit display (white and red); if an error is detected, the red backlight is activated automatically (function can be disabled)
- Operating temperature range: -15...50 °C/+5...122 °F
- Degree of protection: IP65
- Realtime clock with 10-year backup battery

## Multipoint screen

The graphic display terminal is connected to one soft starter only. However, communication is possible between a graphic display terminal and several Altivar soft starters (ATS480) and drives (ATV340, ATV600, and ATV900) connected on the same Modbus serial fieldbus via the RJ45 port (HMI or Modbus serial). In this case, multipoint mode is automatically applied to the graphic display terminal.

A maximum of 32 soft starters or drives can be connected on the same Modbus serial fieldbus.

Apart from the Stop function linked to the STOP/RESET key, multipoint mode cannot be used to apply a reset after an error has been detected or to control the soft starter via the graphic display terminal: in multipoint mode, the Run key and the Local/Remote key are disabled.

## Description

Display:

- Eight lines, 240 x 160 pixels
- Displays bar charts, gages, and trend charts
- Four function keys to facilitate navigation and provide contextual links for enabling functions
- STOP/RESET button: Local control of motor stop command/clearing detected errors
- RUN button: Local control of motor run command
- Navigation buttons:
  - OK button: Saves the current value (ENT)
  - Turn ±: Increases or decreases the value, goes to the next or previous line
  - ESC button: Aborts a value, parameter, or menu to return to the previous selection
  - Home: Root menu
  - Information (i): Contextual help

## References

Description	Reference	Weight kg/ lb
Graphic display terminal	VW3A1111	0.200/ 0.441

(1) Graphic display terminal used as a handheld terminal only.



Remote-mounting kit for mounting graphic display terminal on enclosure door (front panel)



Remote-mounting kit for graphic display terminal (rear panel)

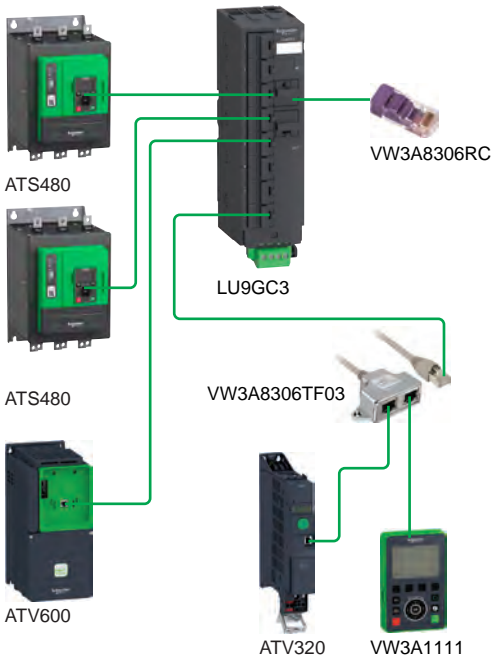

Example of multipoint screen architecture

## Accessories for graphic display terminal

- Remote-mounting kit for mounting on enclosure door with IP65/UL Type 12 degree of protection as standard

The kit includes:

- Tightening tool (also sold separately under the reference ZB5AZ905)
- 1 Cover plate to maintain IP65 protection when there is no terminal connected
- 2 Mounting plate
- 3 RJ45 port for the graphic display terminal
- 4 Seal
- 5 Fixing nut
- 6 Anti-rotation pin
- 7 RJ45 port for connecting the remote-mounting cordset (10 m/32.8 ft maximum)  
Cordsets should be ordered separately depending on the length required.
- 8 Grounding connector

Drilling a hole with a standard  $\varnothing 22$  tool, as used for a pushbutton, allows the unit to be mounted without the need for a cut-out in the enclosure ( $\varnothing 22.5$  mm/ $\varnothing 0.89$  in. drill hole).

## References

Description	Length m/ ft	IP rating	Reference	Weight kg/ lb
<b>Remote mounting kit</b> Order with remote-mounting cordset VW3A1104R●●●	–	65/ UL Type 12	<b>VW3A1112</b>	–
<b>Tightening tool</b> for remote mounting kit	–	–	<b>ZB5AZ905</b>	0.016/ 0.035
<b>Remote-mounting cordset</b> equipped with two RJ45 connectors	1/ 3.28	–	<b>VW3A1104R10</b>	0.050/ 0.110
	3/ 9.84	–	<b>VW3A1104R30</b>	0.150/ 0.331
	5/ 16.4	–	<b>VW3A1104R50</b>	0.250/ 0.551
	10/ 32.8	–	<b>VW3A1104R100</b>	0.500/ 1.102
	–	–	–	–

**USB/Mini B USB cable**  
for connecting the graphic display terminal to a PC

## Multidrop connection accessories

These accessories are used to connect a graphic display terminal to several ATS480 soft starters via a multidrop link. This multidrop connection uses the RJ45 terminal port on the front of the Altivar Soft Starter ATS480.

### Connection accessories

Description	Sold in lots of	Unit reference	Weight kg/ lb	
<b>Modbus splitter box, 10 RJ45 connectors, and one screw terminal block</b>	–	<b>LU9GC3</b>	0.500/ 1.102	
<b>Modbus T-junction boxes</b>	With 0.3 m/0.98 ft integrated cable	–	<b>VW3A8306TF03</b>	0.190/ 0.419
	With 1 m/3.28 ft integrated cable	–	<b>VW3A8306TF10</b>	0.210/ 0.463
<b>Modbus line terminator</b>	For RJ45 connector	R = 120 $\Omega$ C = 1 nF	<b>2</b> <b>VW3A8306RC</b>	0.010/ 0.022

### Cordsets (equipped with two RJ45 connectors)

Used for	Length m/ ft	Reference	Weight kg/ lb
<b>Serial link</b>	0.3/ 0.98	<b>VW3A8306R03</b>	0.025/ 0.055
	1/ 3.28	<b>VW3A8306R10</b>	0.060/ 0.132
	3/ 9.84	<b>VW3A8306R30</b>	0.130/ 0.287
	–	–	–

## DTM

### Presentation

Using FDT/DTM technology, it is possible to configure, control, and diagnose Altivar Soft Starter ATS480 directly in EcoStruxure Control Expert and SoMove software by means of the same software brick (DTM).

FDT/DTM technology standardizes the communication interface between field devices and host systems. The DTM contains a uniform structure for managing soft starter access parameters.

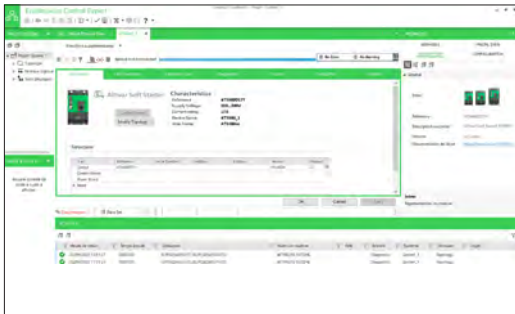

Altivar Soft Starter ATS480 DTM in EcoStruxure Control Expert

### Specific functions of Altivar Soft Starter ATS480

- Offline or online access to soft starter data
- Configuration and management of cybersecurity features
- Access to audit log file for cybersecurity threat intelligence
- Transfer of configuration files from and to the soft starter
- Customization
- Access to soft starter parameters and communication modules
- Graphic interface to assist with configuration of the ATS480 functions
- Detected error and warning logs (with timestamping)

Advantages of the DTM library in EcoStruxure Control Expert:

- Single tool for configuration, setup, and diagnostics
- Network scan for automatic recognition of network configuration
- Ability to add/remove, copy/paste configuration files from other soft starters in the same architecture
- Single input point for all parameters shared between the ePAC (programmable controller) and the Altivar Soft Starter ATS480
- Creation of profiles for implicit communication with the ePAC as well as dedicated profiles for programs with DFBs (derived function blocks)
- Integration in the fieldbus topology
- Soft starter configuration is an integral part of the EcoStruxure Control Expert project file (STU) and the archive file (STA)

Advantages of the DTM library in SoMove:

- Altivar-oriented software environment
- Wired connection to USB-A port or the Ethernet communication port
- Standard cable (file transfer performance)
- Third-party software and downloads:
  - The Altivar Soft Starter DTM library is a flexible, open, and interactive tool that can be used in a third-party FDT.
  - DTMs can be downloaded from our [website](#).

## SoMove software

### Presentation

SoMove software for PC is used to configure, set up, maintain, and upgrade the firmware (see [page 34](#)) of Altivar Soft Starter ATS480.

In addition to the functions offered by the DTM, SoMove software features the conversion of ATS48 into an ATS480 configuration.

The software can be connected to Altivar Soft Starter ATS480 via:

- Modbus connection
- Ethernet Modbus TCP (1) and WiFi connection with the WiFi dongle **TCSEGWB131W**
- Ethernet Modbus TCP (1) connection
- CANopen (1)

For more information on SoMove setup software, please consult the [SoMove Setup Software](#) catalog.

(1) Requires an optional communication module.



SoMove software

**Table showing possible combinations of accessories for ATS480**

ATS480 reference	Protective covers for power terminals	Line chokes	DNV kit
ATS480D17Y	–	VZ1L015UM17T	–
ATS480D22Y	–	VZ1L030U800T	–
ATS480D32Y	–	VZ1L040U600T	–
ATS480D38Y	–	VZ1L040U600T	–
ATS480D47Y	–	VZ1L070U350T	–
ATS480D62Y	–	VZ1L070U350T	VW3G48106
ATS480D75Y	–	VZ1L150U170T	VW3G48106
ATS480D88Y	–	VZ1L150U170T	VW3G48106
ATS480C11Y	–	VZ1L150U170T	VW3G48106
ATS480C14Y	LA9F702	VZ1L150U170T	VW3G48106
ATS480C17Y	LA9F702	VZ1L250U100T	VW3G48106
ATS480C21Y	LA9F703	VZ1L250U100T	VW3G48107
ATS480C25Y	LA9F703	VZ1L250U100T	VW3G48107
ATS480C32Y	LA9F703	VZ1L325U075T	VW3G48107
ATS480C41Y	LA9F704	VZ1L530U045T	VW3G48108
ATS480C48Y	LA9F704	VZ1L530U045T	VW3G48108
ATS480C59Y	LA9F704	VZ1LM10U024T	VW3G48108
ATS480C66Y	LA9F704	VZ1LM10U024T	VW3G48108
ATS480C79Y	–	VZ1LM10U024T	VW3G48109
ATS480M10Y	–	VZ1LM10U024T	VW3G48109
ATS480M12Y	–	VZ1LM14U016T	VW3G48109

**List of communication modules**

Description	Reference
Modbus TCP, EtherNet/IP	<a href="#">VW3A3720</a>
CANopen daisy chain	<a href="#">VW3A3608</a>
CANopen SUB-D	<a href="#">VW3A3618</a>
CANopen screw terminal block	<a href="#">VW3A3628</a>
PROFINET	<a href="#">VW3A3647</a>
PROFIBUS DP V1	<a href="#">VW3A3607</a>

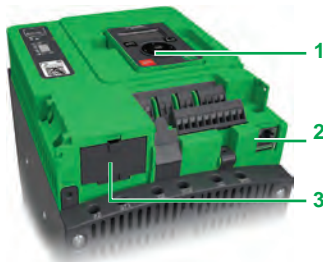

Altivar Soft Starter ATS480 ports and slots

## Description

The Altivar Soft Starter ATS480 range has been designed to simplify connections to communication buses and networks by means of the following:

- 1 Integrated RJ45 communication port for HMI on the front
- 2 Integrated RJ45 communication port for Modbus fieldbus
- 3 Slot available for an additional communication module

## Functions

Altivar Soft Starter ATS480 functions can be accessed via the communication buses and networks:

- Control
- Monitoring
- Adjustment
- Configuration

The command may come from different sources:

- Digital input or analog I/O terminals
- Communication bus or network
- Remote/local display terminals

As one of the advanced functions, ATS480 control sources can be managed and switched according to the application requirements.

The communication periodic I/O data assignment can be selected using the network configuration software.

The Altivar Soft Starter ATS480 can be controlled according to two communication profiles:

- "Standard" communication profile used on Altivar Soft Starter ATS480
- "Compatibility" communication profile used on ATS48 connected through Modbus serial

Communication is monitored according to criteria specific to each protocol.

Regardless of protocol type, the response of the soft starter to a detected communication interruption can be configured as follows:

- Freewheel stop, stop on ramp, fast stop, or braked stop
- Maintain the last command received
- Ignore the detected error

## Modbus serial link

### Connection accessories

Description	Item	Length m/ ft	Reference	Weight kg/ lb
<b>Modbus splitter box</b> 10 RJ45 connectors and one screw terminal block	1	–	LU9GC3	0.500/ 1.102
<b>Cordsets for modbus serial link</b> equipped with two RJ45 connectors	2	0.3/ 0.98	VW3A8306R03	0.025/ 0.055
		1/ 3.28	VW3A8306R10	0.060/ 0.132
		3/ 9.84	VW3A8306R30	0.130/ 0.287
<b>Modbus T-junction boxes</b> (with integrated cable)	3	0.3/ 0.98	VW3A8306TF03	0.190/ 0.419
		1/ 3.28	VW3A8306TF10	0.210/ 0.463
<b>Modbus line terminator</b> For RJ45 connector (2)	4	–	VW3A8306RC	0.020/ 0.044
		–	VW3A8306R	0.020/ 0.044

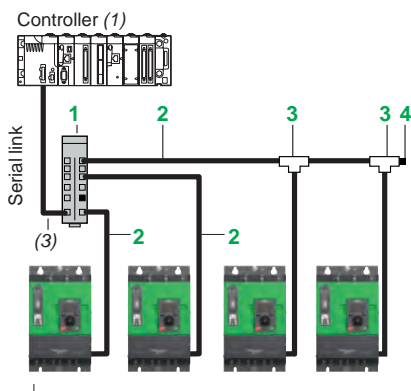

Altivar Soft Starter ATS480

Example of serial link architecture

(1) Please refer to the [Modicon](#) catalogs.

(2) Sold in lots of two.

(3) Cable depends on the controller.

# Altivar Soft Starter ATS480

## Soft starters for asynchronous motors

Options: communication modules



Communication module slot

### Modbus TCP and EtherNet/IP networks

#### Presentation

This communication module offers standard services regularly used in industrial networks:

- EtherNet IP adapter including standard CIP objects (communication adapter objects), compliant with ODVA specification
- The RSTP connection allows ring topology to help ensure continuity of service.
- Dual port allows daisy chain connection to simplify cabling and network infrastructure (no need to use a switch).
- Modbus TCP message handling is based on the Modbus protocol and is used to exchange process data with other network devices (e.g. a PLC). It provides Altivar Soft Starter ATS480 with access to the Modbus protocol and to the high performance of the Ethernet network, which is the communication standard for numerous devices.
- SNMP (Simple Network Management Protocol) offers standard diagnostics services for network management tools.
- The FDR (fast device replacement) service allows automatic reconfiguration of a new device installed to replace an existing device.
- Device integrity is reinforced by disabling some unused services.
- Setup and adjustment tools (SoMove, EcoStruxure Control Expert with DTM) can be connected locally or remotely.
- The embedded web server is used to display operating data and dashboards as well as to configure and perform system elements diagnostics from any web browser.

These numerous services offered by Altivar Soft Starter ATS480 simplify integration into Schneider Electric Automation systems.

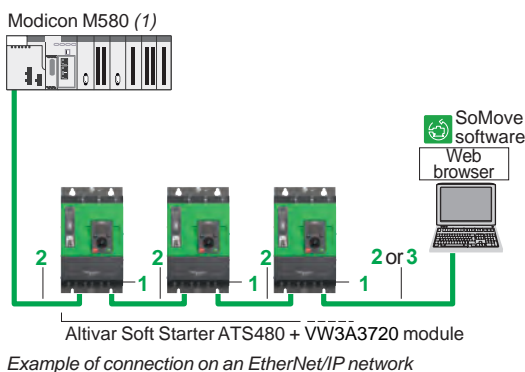

Description	Item	Length m/ ft	Reference	Weight kg/ lb
<b>Communication module (2)</b>				
<b>EtherNet/IP and Modbus TCP dual port module</b>	1	–	VW3A3720	0.020/ 0.044
For connection to the Modbus TCP or EtherNet/IP network				
Ports: Two RJ45 connectors				
<ul style="list-style-type: none"> <li>■ 10/100 Mbps, half duplex and full duplex</li> <li>■ Embedded web server</li> </ul>				
Requires cordset				
490NTW000●●/●●U or 490NTC●●				
<b>ConneXium cordsets (3)</b>				
<b>Straight shielded twisted pair cables</b>	2	2/ 6.56	490NTW00002	–
equipped with two RJ45 connectors conforming to EIA/TIA-568 category 5 and IEC 11801/EN 50173-1, class D				
		5/ 16	490NTW00005	–
		12/ 39	490NTW00012	–
<b>Crossover shielded twisted pair cables</b>	3	5/ 16	490NTC00005	–
equipped with two RJ45 connectors conforming to EIA/TIA-568 category 5 and IEC 11801/EN 50173-1, class D				
		15/ 49	490NTC00015	–
<b>Straight shielded twisted pair cables</b>	2	2/ 6.56	490NTW00002U	–
equipped with two RJ45 connectors conforming to UL and CSA 22.1				
		5/ 16	490NTW00005U	–
		12/ 39	490NTW00012U	–

(1) Please consult the [PLC, PAC and Dedicated Controllers](#) page on our website.

(2) Minimum version compatible with Altivar Soft Starter ATS480: V2.1

(3) Also exist in 40 and 80 m/131 and 262 ft lengths. For other ConneXium connection accessories, please refer to the [Modicon Switch](#) catalog.



# Altivar Soft Starter ATS480

## Soft starters for asynchronous motors

### Options: communication modules



VW3A3608



VW3A3618

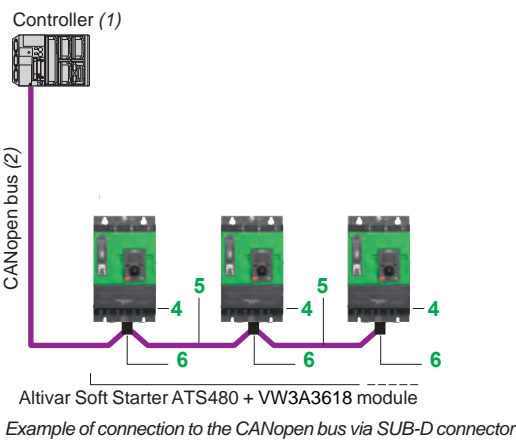
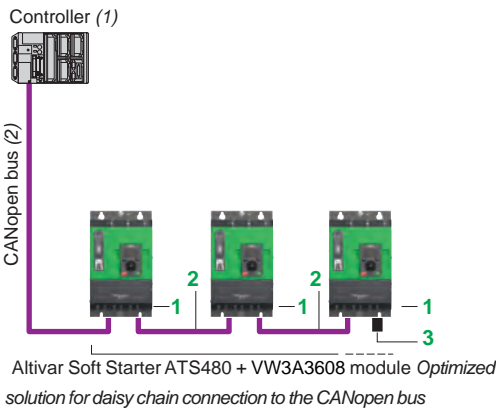

### CANopen bus

Description	Item	Length m/ ft	Reference	Weight kg/ lb
-------------	------	--------------------	-----------	---------------------

#### Communication module

<b>CANopen daisy chain module</b> Ports: Two RJ45 connectors	<b>1</b>	–	<b>VW3A3608</b>	–
---	----------	---	-----------------	---

#### Connection to RJ45 connector

(optimized solution for daisy chain connection on CANopen bus)

<b>CANopen cordsets</b> equipped with two RJ45 connectors	<b>2</b>	0.3/ 0.98	<b>VW3CANCARR03</b>	0.050/ 0.110
		1/ 3.28	<b>VW3CANCARR1</b>	0.500/ 1.102

<b>CANopen line terminator for RJ45 connector</b>	<b>3</b>	–	<b>TCSCAR013M120</b>	–
---	----------	---	----------------------	---

#### Communication module

<b>CANopen SUB-D module</b> Ports: One 9-way male SUB-D connector	<b>4</b>	–	<b>VW3A3618</b>	–
--	----------	---	-----------------	---

#### Connection to SUB-D connector

<b>CANopen cables (2) (3)</b> Standard cable, C€ mark Low smoke zero halogen Flame-retardant (IEC 60332-1)	<b>5</b>	50/ 164	<b>TSXCANCA50</b>	4.930/ 10.869
		100/ 328	<b>TSXCANCA100</b>	8.800/ 19.401
		300/ 984	<b>TSXCANCA300</b>	24.560/ 54.145

<b>CANopen cables (2) (3)</b> UL certification, C€ mark Flame-retardant (IEC 60332-2)	<b>5</b>	50/ 164	<b>TSXCANCB50</b>	3.580/ 7.893
		100/ 328	<b>TSXCANCB100</b>	7.840/ 17.284
		300/ 984	<b>TSXCANCB300</b>	21.870/ 48.215

<b>CANopen cables (2) (3)</b> Cable for harsh environments or mobile installations, C€ mark Low smoke zero halogen Flame-retardant (IEC 60332-1)	<b>5</b>	50/ 164	<b>TSXCANCD50</b>	3.510/ 7.738
		100/ 328	<b>TSXCANCD100</b>	7.770/ 17.130
		300/ 984	<b>TSXCANCD300</b>	7.770/ 17.130

<b>IP20 straight CANopen connector (4)</b> 9-way female SUB-D connector with line terminator that can be deactivated For connecting CAN-H, CAN-L, CAN-GND	<b>6</b>	–	<b>TSXCANKCDF180T</b>	0.049/ 0.108
---	----------	---	-----------------------	-----------------

- (1) Please consult the [PLC, PAC and Dedicated Controllers](#) page on our website.  
 (2) Cable depends on the controller, please refer to the [CANopen for machines](#) catalog.  
 (3) Standard environment:  
 - No particular environmental constraints  
 - Operating temperature between 5 and 60 °C/41 and 140 °F  
 - Fixed installation  
 Harsh environment:  
 - Resistance to hydrocarbons, industrial oils, detergents, solder splashes  
 - Relative humidity up to 100%  
 - Saline atmosphere  
 - Operating temperature between -10 and +70 °C/+14 and 158 °F  
 - Significant temperature variations  
 (4) Only straight connectors are compatible with Altivar Soft Starter ATS480.

# Altivar Soft Starter ATS480

Soft starters for asynchronous motors  
Options: communication modules



VW3A3628

Controller (1)

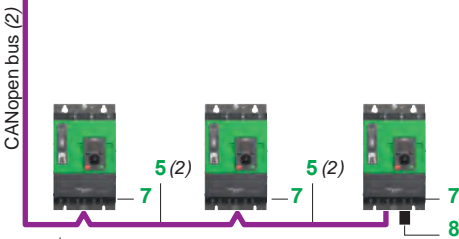

Altivar Soft Starter ATS480 + VW3A3628 module  
Example of connection to the CANopen bus with a screw terminal block



VW3A3647



VW3A3607

## CANopen bus (continued)

Description	Item	Length m/ ft	Reference	Weight kg/ lb
<b>Communication module</b>				
<b>CANopen module</b> Port: One 5-way screw terminal block	7	–	VW3A3628	–
<b>Other connexion accessories and cordsets</b>				
<b>CANopen IP20 cordsets</b> equipped with two 9-way female SUB-D connectors Standard cable, C€ mark. Low smoke zero halogen Flame-retardant (IEC 60332-1)	–	0.3/ 0.98	TSXCANCADD03	0.091/ 0.201
	1/	3.28	TSXCANCADD1	0.143/ 0.315
	3/	9.84	TSXCANCBDD3	0.268/ 0.591
	5/	16.40	TSXCANCBDD5	0.400/ 0.882
	–	–	TSXCANTDM4	0.196/ 0.432
<b>IP20 CANopen tap junction boxes</b> equipped with: ■ Four 9-way male SUB-D connectors + screw terminal block for trunk cable tap link ■ Line terminator	–	–	VW3CANTAP2	0.480/ 1.058
<b>IP20 CANopen tap junction boxes</b> equipped with: ■ Two screw terminal blocks for trunk cable tap link ■ Two RJ45 connectors for connecting soft starters ■ One RJ45 connector for connecting a PC	–	–	TSCAR01NM120	–
<b>CANopen line terminator for screw terminal connector (3)</b>	8	–		

## PROFINET network

Description	Reference	Weight kg/ lb
<b>Communication module</b>		
<b>PROFINET module</b> equipped with two RJ45 connectors	VW3A3647 ▲	0.290/ 0.639

## PROFIBUS DP V1 bus (4)

Description	Reference	Weight kg/ lb
<b>Communication module</b>		
<b>PROFIBUS DP V1 module</b> Port: One 9-way female SUB-D connector Conforming to PROFIBUS DP V1 Offers several message handling modes based on DP V1	VW3A3607	0.140/ 0.309

## SUB-D connection

IP20 straight connectors (5) for Profibus module	LU9AD7	–
---	--------	---

(1) Please refer to the [Modicon catalogs](#).

(2) Refer to the connection to SUB-D connector cable selection table on the previous page.

(3) Sold in lots of two.

(4) Minimum version compatible with Altivar Soft Starters ATS480: V1.16.

(5) Only straight connectors are compatible with Altivar Soft Starters ATS480.

▲ Available Q2 2022



VZ1L150U170T

### Line chokes

The use of line chokes is recommended in particular when installing several soft starters on the same line supply to limit low frequency interference that may affect low level loads.

The inductance values are defined for a voltage drop between 3% and 5% of the nominal line voltage.

Install the line choke between the line contactor and the soft starter.

### References

Corresponding soft starter	Line choke			Reference	Weight kg/ lb
	Inductance value mH	Nominal current A	Degree of protection		
ATS480D17Y	1.7	15	IP20	<a href="#">VZ1L015UM17T</a>	2.100/ 4.630
ATS480D22Y	0.8	30	IP20	<a href="#">VZ1L030U800T</a>	4.100/ 9.039
ATS480D32Y...D38Y	0.6	40	IP20	<a href="#">VZ1L040U600T</a>	5.100/ 11.2
ATS480D47Y...D62Y	0.35	70	IP20	<a href="#">VZ1L070U350T</a>	8.000/ 17.6
ATS480D75Y...C14Y	0.17	150	IP00	<a href="#">VZ1L150U170T</a>	14.9/ 32.8
ATS480C17Y...C25Y	0.1	250	IP00	<a href="#">VZ1L250U100T</a>	24.3/ 53.5
ATS480C32Y	0.075	325	IP00	<a href="#">VZ1L325U075T</a>	28.9/ 63.7
ATS480C41Y...C48Y	0.045	530	IP00	<a href="#">VZ1L530U045T</a>	37.0/ 81.5
ATS480C59Y...M10Y	0.024	1025	IP00	<a href="#">VZ1LM10U024T</a>	66.0/ 145.5
ATS480M12Y	0.016	1435	IP00	<a href="#">VZ1LM14U016T</a>	80.0/ 176.3

# Altivar Soft Starter ATS480

Soft starters for asynchronous motors  
Options: DNV kits, protective covers

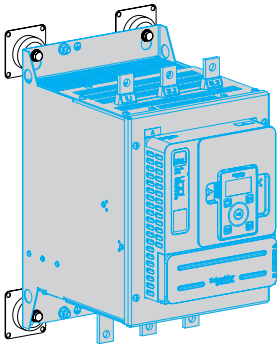

VW3G48106



LA9F703

### DNV kits

Altivar Soft Starter ATS480 is an open component, which has to be installed in a cabinet. To comply with marine vibration requirements, it is recommended that the complete cabinet (the system) in which the soft starter is installed is taken into account. Following dampers are optional and could be used only if the soft starter itself has to comply with marine vibration requirements.

### References

Corresponding soft starter	Reference	Weight kg/ lb
ATS480D62Y...C17Y	<a href="#">VW3G48106</a>	0.600/ 1.323
ATS480C21Y...C32Y	<a href="#">VW3G48107</a>	0.680/ 1.499
ATS480C41Y...C66Y	<a href="#">VW3G48108</a>	3.400/ 7.496
ATS480C79Y...M12Y	<a href="#">VW3G48109</a>	4.400/ 9.700

### Protective covers for power terminals

The protective covers are intended to be mounted on 140 to 660 A units that have unprotected power terminals. The protective covers are to be used with eyelet connections.

### References

Corresponding soft starter	Number of covers per set	Reference	Weight kg/ lb
ATS480C14Y...C17Y	6	<a href="#">LA9F702</a>	0.250/ 0.551
ATS480C21Y...C32Y	6	<a href="#">LA9F703</a>	0.250/ 0.551
ATS480C41Y...C66Y	6	<a href="#">LA9F704</a>	0.250/ 0.551

# Altivar Soft Starter ATS480

## Soft starters for asynchronous motors

### Firmware update



Firmware update through Modbus TCP/Ethernet/IP or Modbus serial using SoMove

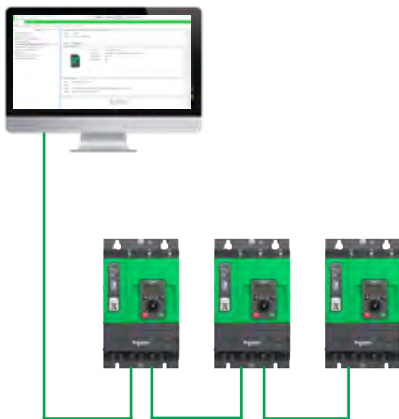

Firmware upload of several ATS480 at the same time through Modbus TCP/Ethernet/IP or Modbus serial using Ecostruxure Automation Device Maintenance

### Firmware update using SoMove or EcoStruxure Automation Device Maintenance

#### Presentation

The firmware of the Altivar Soft Starter ATS480 offer can be updated.

This includes:

- The firmware of the ATS480 product
- The texts and languages of the display terminals
- The firmware of the display terminals (1)
- The firmware of communication modules (1)

The firmware and languages are available from the [Altivar Soft Starter ATS480 page on our website](#). Using Schneider Electric Software Update tool, notifications are automatically sent when new updates are available.

#### Firmware update process

Different ways are proposed to update the firmware:

- Single product firmware update using SoMove software (2)
- Multiple product firmware update using EcoStruxure Automation Device Maintenance (3)

The update process comprises two steps:

- The first step is to transfer the firmware to the product, which can be performed when the motor is either running or stopped. The control section of the ATS480 must be powered on. The package of product firmware and keypad languages can be uploaded in one operation via the Modbus serial port, the Ethernet port of the VW3A3720 communication module, or the PROFINET port of the VW3A3647 communication module. The Modbus TCP/EtherNet/IP communication module firmware is uploaded in a separate package.
- The second step is to apply the uploaded firmware in the products: the control section must be powered on and this operation can only be performed with the motor stopped. The firmware can be applied from EcoStruxure Automation Device Maintenance, SoMove, or the display terminal.

This two-step process avoids the risk of a potential loss of usability of the product in case of wrong operations during the firmware update process, while reducing the amount of time that the motor is stopped.

Cybersecurity-related features in the firmware update:

- The firmware is delivered with a digital certificate that is generated by a cryptographic key.
- The ATS480 checks the authenticity of the firmware before applying it. The authenticity of the firmware is also checked at each power-up.
- The firmware can only be updated and applied by a registered user with a valid user account and associated rights.
- Firmware update operations are recorded as events in the security related reports.

#### Connection accessories

Description	Length m/ ft	Reference	Weight kg/ lb
<b>High-speed USB-A/RJ45 flashing cordset</b>	2.5/ 8.20	<a href="#">VW3A8127</a> ▲	–
<b>Connection cable USB/RJ45</b> For connection between PC and soft starter	2.5/ 8.20	<a href="#">TCSMCNAM3M002P</a>	–
<b>RJ45 female/female adapter</b> For connection to plain text display terminal	–	<a href="#">VW3A1105</a>	0.010/ 0.022

(1) Contact Schneider Electric Services to update the firmware of the PROFINET or PROFIBUS DP communication module, or the plain text display terminal.

(2) Refer to [page 26](#).

(3) Download EcoStruxure Automation Device Maintenance from its [dedicated page on our website](#).

▲ Available Q1 2022

# Altivar Soft Starter ATS480

## Soft starters for asynchronous motors

### Type of coordination, variants on the wiring diagram

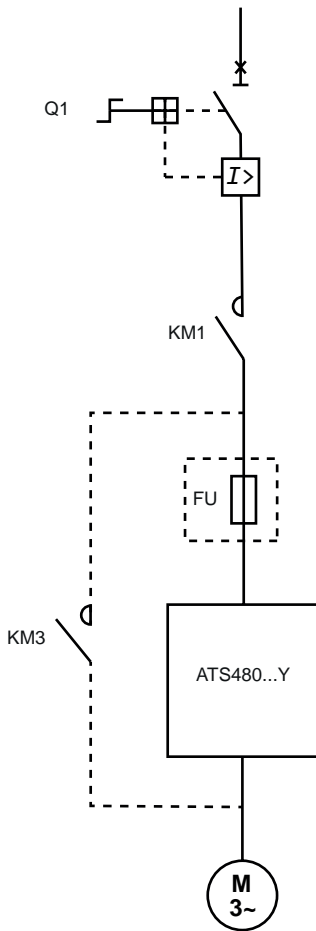

### Presentation

#### Type of coordination

The EN/IEC 60947-4-1 standard makes a distinction between two different types of coordination, which are designated coordination type 1 and coordination type 2:

- Type 1 coordination requires that, under short-circuit conditions, the contactor or soft starter shall cause no danger to persons or the installation and may not be suitable for further service without repair and replacement of parts.
- Type 2 coordination requires that, under short-circuit conditions, the contactor or soft starter shall cause no danger to persons or the installation and shall be suitable for further use. The risk of contact welding is recognized, in which case the manufacturer shall indicate the measures to be taken as regards the maintenance of the equipment.

- For type 2 coordination (according to IEC 60947-4-1 and IEC 60947-4-2), install fast-acting fuses in series with the soft starter to ensure that the ATS480 will be protected in the event of a short circuit. After a short circuit, fast-acting fuses must be replaced, and the contactor must be checked.

**Note:** Use of a short-circuit protection device (SCPD) that does not comply with the manufacturer's specification can invalidate the coordination.

#### Bypass

The bypass contactor is optional as the ATS480 is able to power the motor during starting, running at fixed speed, and stopping without any loss of performance. When used, the bypass contactor is controlled based on relay R2. The assignment of relay R2 cannot be modified.

When bypassed, an ATS480 with a lower current rating could be used (please refer to [page 18](#)) or the ATS480 can operate at a maximum ambient temperature of 50 °C without derating.

#### Line contactor

The line contactor on ATS480 is optional.

When used, the line contactor is controlled by relay R1. There are two possibilities influencing the wiring diagram:

- R1 assigned to "Operating State Fault":
  - The line contactor is controlled by Power ON and Power OFF push buttons and relay R1. Relay R1 is activated when the soft starter is powered up (minimum CL1/CL2 control) and is deactivated when an error is detected and the motor switches to freewheel mode.
- R1 assigned to "Line Contactor":
  - The line contactor is controlled by relay R1 on the basis of the ATS480 RUN and STOP commands. Relay R1 is activated by a RUN command (or a preheating command). It is deactivated at the end of braking or deceleration, or when the motor switches to freewheel mode after a STOP command. It is also deactivated when an error is detected: the motor switches to freewheel mode at this point.

**Note:** ATS48 and ATS480 control supply voltage may differ, check the value in the installation guide before starting the system.

#### Thermal monitoring

The Altivar Soft Starter ATS480 will help to protect the motor and the cables against overloads. If this monitoring function is disabled, external thermal monitoring must be provided.

# Altivar Soft Starter ATS480

Soft starters for asynchronous motors  
Type 1 coordination according to IEC 60947-4-1  
and IEC 60947-4-2

## 230 V power supply, ATS480 connected in-line

Motor power kW	Combination I <sub>q</sub> (kA)	ATS480		Circuit breaker (1) Q1 reference	Line contactor (2) KM1 reference	Bypass contactor (2) KM3 reference
		Class 10 Normal duty	Class 20 Heavy duty			
3	50	–	ATS480D17Y	GV2L20	LC1D18●●	LC1D18●●
4	50	ATS480D17Y	ATS480D22Y	GV2L20	LC1D18●●	LC1D18●●
5.5	50	ATS480D22Y	ATS480D32Y	GV2L22	LC1D25●●	LC1D25●●
7.5	50	ATS480D32Y	ATS480D38Y	GV2L32	LC1D32●●	LC1D32●●
9	50	ATS480D38Y	ATS480D47Y	GV3L40	LC1D38●●	LC1D38●●
11	50	ATS480D47Y	ATS480D62Y	GV3L65	LC1D50A●●	LC1D50A●●
15	50	ATS480D62Y	ATS480D75Y	GV3L65	LC1D65A●●	LC1D65A●●
18.5	50	ATS480D75Y	ATS480D88Y	GV4L80B	LC1D80●●	LC1D80●●
22	50	ATS480D88Y	ATS480C11Y	GV4L115B	LC1D115●●	LC1D115●●
30	50	ATS480C11Y	ATS480C14Y	GV4L115B	LC1D115●●	LC1D115●●
37	50	ATS480C14Y	ATS480C17Y	NSX160F MA	LC1D150●●	LC1D150●●
45	50	ATS480C17Y	ATS480C21Y	NSX250F MA	LC1G185●●●●	LC1G185●●●●
55	50	ATS480C21Y	ATS480C25Y	NSX250F MA	LC1G225●●●●	LC1G225●●●●
75	50	ATS480C25Y	ATS480C32Y	NSX400N MicroLogic 1.3 M	LC1G265●●●●	LC1G265●●●●
90	50	ATS480C32Y	ATS480C41Y	NSX400N MicroLogic 1.3 M	LC1G330●●●●	LC1G330●●●●
110	70	ATS480C41Y	ATS480C48Y	NSX630N MicroLogic 1.3 M	LC1G400●●●●	LC1G400●●●●
132	70	ATS480C48Y	ATS480C59Y	NSX630N MicroLogic 1.3 M	LC1G500●●●●	LC1G500●●●●
160	70	ATS480C59Y	ATS480C66Y	NS630bN MicroLogic 5.0 LR Off	LC1G630●●●●	LC1G630●●●●
200	70	ATS480C66Y	ATS480C79Y	NS800N MicroLogic 5.0 LR Off	LC1G630●●●●	LC1G630●●●●
220	70	ATS480C79Y	ATS480M10Y	NS800N MicroLogic 5.0 LR Off	LC1G800●●●●	LC1G800●●●●
250	70	ATS480M10Y	ATS480M12Y	NS1000N MicroLogic 5.0 LR Off	LC1F1000●●	LC1F1000●●
355	42	ATS480M12Y	–	NS1250N MicroLogic 5.0 LR Off	LC1F2600●●	LC1F2600●●

## 230 V power supply, ATS480 connected inside delta

Motor power kW	Combination I <sub>q</sub> (kA)	ATS480		Circuit breaker (1) Q1 reference	Line contactor (2) KM1 reference	Bypass contactor (2) KM3 reference
		Class 10 Normal duty	Class 20 Heavy duty			
5.5	50	–	ATS480D17Y	GV2L22	LC1D25●●	LC1D25●●
7.5	50	ATS480D17Y	ATS480D22Y	GV2L32	LC1D32●●	LC1D32●●
9	50	ATS480D22Y	ATS480D32Y	GV3L40	LC1D38●●	LC1D38●●
15	50	ATS480D32Y	ATS480D38Y	GV3L65	LC1D65A●●	LC1D65A●●
18.5	50	ATS480D38Y	ATS480D47Y	GV4L80B	LC1D80●●	LC1D80●●
22	50	ATS480D47Y	ATS480D62Y	GV4L115B	LC1D115●●	LC1D115●●
30	50	ATS480D62Y	ATS480D75Y	GV4L115B	LC1D115●●	LC1D115●●
37	50	ATS480D75Y	ATS480D88Y	NSX160F MA	LC1D150●●	LC1D150●●
45	50	ATS480D88Y	ATS480C11Y	NSX250F MA	LC1G185●●●●	LC1G185●●●●
55	50	ATS480C11Y	ATS480C14Y	NSX250F MA	LC1G225●●●●	LC1G225●●●●
75	50	ATS480C14Y	ATS480C17Y	NSX400N MicroLogic 1.3 M	LC1G265●●●●	LC1G265●●●●
90	50	ATS480C17Y	ATS480C21Y	NSX400N MicroLogic 1.3 M	LC1G330●●●●	LC1G330●●●●
110	70	ATS480C21Y	ATS480C25Y	NSX630N MicroLogic 1.3 M	LC1G400●●●●	LC1G400●●●●
132	70	ATS480C25Y	ATS480C32Y	NSX630N MicroLogic 1.3 M	LC1G500●●●●	LC1G500●●●●
160	70	ATS480C32Y	ATS480C41Y	NS630bN MicroLogic 5.0 LR Off	LC1G630●●●●	LC1G630●●●●
220	70	ATS480C41Y	ATS480C48Y	NS800N MicroLogic 5.0 LR Off	LC1G800●●●●	LC1G800●●●●
250	70	ATS480C48Y	ATS480C59Y	NS1000N MicroLogic 5.0 LR Off	LC1F1000●●	LC1F1000●●
355	42	ATS480C79Y	ATS480M10Y	NS1250N MicroLogic 5.0 LR Off	LC1F2600●●	LC1F2600●●

(1) Set I<sub>rm</sub> current of the circuit breaker (when available) to a minimum of six times the current rating of the soft starter.

(2) Replace with the appropriate control circuit voltage code (refer to page 44). ATS48 and ATS480 control supply voltage may differ, check the value in the installation guide before starting the system.

380/400/415 V power supply, ATS480 connected in-line						
Motor power kW	Combination Iq (kA)	ATS480		Circuit breaker (1) Q1 reference	Line contactor (2) KM1 reference	Bypass contactor (2) KM3 reference
		Class 10 Normal duty	Class 20 Heavy duty			
5.5	50	–	ATS480D17Y	GV2L20	LC1D18●●	LC1D18●●
7.5	50	ATS480D17Y	ATS480D22Y	GV2L20	LC1D18●●	LC1D18●●
11	50	ATS480D22Y	ATS480D32Y	GV2L22	LC1D25●●	LC1D25●●
15	50	ATS480D32Y	ATS480D38Y	GV2L32	LC1D32●●	LC1D32●●
18.5	50	ATS480D38Y	ATS480D47Y	GV3L40	LC1D38●●	LC1D38●●
22	50	ATS480D47Y	ATS480D62Y	GV3L65	LC1D50A●●	LC1D50A●●
30	50	ATS480D62Y	ATS480D75Y	GV3L65	LC1D65A●●	LC1D65A●●
37	50	ATS480D75Y	ATS480D88Y	GV4L80N	LC1D80●●	LC1D80●●
45	50	ATS480D88Y	ATS480C11Y	NSX100N MA	LC1D115●●	LC1D115●●
55	50	ATS480C11Y	ATS480C14Y	NSX160N MA	LC1D115●●	LC1D115●●
75	50	ATS480C14Y	ATS480C17Y	NSX160N MA	LC1D150●●	LC1D150●●
90	50	ATS480C17Y	ATS480C21Y	NSX250N MA	LC1G185●●●●	LC1G185●●●●
110	50	ATS480C21Y	ATS480C25Y	NSX250N MA	LC1G225●●●●	LC1G225●●●●
132	50	ATS480C25Y	ATS480C32Y	NSX400N MicroLogic 1.3 M	LC1G265●●●●	LC1G265●●●●
160	50	ATS480C32Y	ATS480C41Y	NSX400N MicroLogic 1.3 M	LC1G330●●●●	LC1G330●●●●
220	70	ATS480C41Y	ATS480C48Y	NSX630H MicroLogic 1.3 M	LC1G500●●●●	LC1G500●●●●
250	70	ATS480C48Y	ATS480C59Y	NSX630H MicroLogic 1.3 M	LC1G500●●●●	LC1G500●●●●
315	70	ATS480C59Y	ATS480C66Y	NS630bH MicroLogic 5.0 LR Off	LC1G630●●●●	LC1G630●●●●
355	70	ATS480C66Y	ATS480C79Y	NS800H MicroLogic 5.0 LR Off	LC1G630●●●●	LC1G630●●●●
400	70	ATS480C79Y	ATS480M10Y	NS800H MicroLogic 5.0 LR Off	LC1G800●●●●	LC1G800●●●●
500	70	ATS480M10Y	ATS480M12Y	NS1000H MicroLogic 5.0 LR Off	LC1F1000●●	LC1F1000●●
630	42	ATS480M12Y	–	NS1250H MicroLogic 5.0 LR Off	LC1F2600●●	LC1F2600●●

380/400/415 V power supply, ATS480 connected inside delta						
Motor power kW	Combination Iq (kA)	ATS480		Circuit breaker (1) Q1 reference	Line contactor (2) KM1 reference	Bypass contactor (2) KM3 reference
		Class 10 Normal duty	Class 20 Heavy duty			
11	50	–	ATS480D17Y	GV2L22	LC1D25●●	LC1D25●●
15	50	ATS480D17Y	ATS480D22Y	GV2L32	LC1D32●●	LC1D32●●
18.5	50	ATS480D22Y	ATS480D32Y	GV3L40	LC1D38●●	LC1D38●●
22	50	ATS480D32Y	ATS480D38Y	GV3L65	LC1D50A●●	LC1D50A●●
30	50	ATS480D38Y	ATS480D47Y	GV3L65	LC1D65A●●	LC1D65A●●
45	50	ATS480D47Y	ATS480D62Y	NSX100N MA	LC1D115●●	LC1D115●●
55	50	ATS480D62Y	ATS480D75Y	NSX160N MA	LC1D115●●	LC1D115●●
55	50	ATS480D75Y	ATS480D88Y	NSX160N MA	LC1D115●●	LC1D115●●
75	50	ATS480D88Y	ATS480C11Y	NSX160N MA	LC1D150●●	LC1D150●●
90	50	ATS480C11Y	ATS480C14Y	NSX250N MA	LC1G185●●●●	LC1G185●●●●
110	50	ATS480C14Y	ATS480C17Y	NSX250N MA	LC1G225●●●●	LC1G225●●●●
132	50	ATS480C17Y	ATS480C21Y	NSX400N MicroLogic 1.3 M	LC1G265●●●●	LC1G265●●●●
160	50	ATS480C21Y	ATS480C25Y	NSX400N MicroLogic 1.3 M	LC1G330●●●●	LC1G330●●●●
220	70	ATS480C25Y	ATS480C32Y	NSX630H MicroLogic 1.3 M	LC1G500●●●●	LC1G500●●●●
250	70	ATS480C32Y	ATS480C41Y	NSX630H MicroLogic 1.3 M	LC1G500●●●●	LC1G500●●●●
315	70	ATS480C41Y	ATS480C48Y	NS630bH MicroLogic 5.0 LR Off	LC1G630●●●●	LC1G630●●●●
355	70	ATS480C48Y	ATS480C59Y	NS800H MicroLogic 5.0 LR Off	LC1G630●●●●	LC1G630●●●●
400	70	ATS480C59Y	ATS480C66Y	NS800H MicroLogic 5.0 LR Off	LC1G800●●●●	LC1G800●●●●
500	70	ATS480C66Y	ATS480C79Y	NS1000H MicroLogic 5.0 LR Off	LC1F1000●●	LC1F1000●●
630	42	ATS480C79Y	ATS480M10Y	NS1250H MicroLogic 5.0 LR Off	LC1F2600●●	LC1F2600●●

(1) Set I<sub>rm</sub> current of the circuit breaker (when available) to a minimum of six times the current rating of the soft starter.

(2) Replace with the appropriate control circuit voltage code (refer to page 44). ATS48 and ATS480 control supply voltage may differ, check the value in the installation guide before starting the system.



# Altivar Soft Starter ATS480

Soft starters for asynchronous motors  
Type 1 coordination according to IEC 60947-4-1 and IEC 60947-4-2

440 V power supply, ATS480 connected in-line						
Motor power kW	Combination Iq (kA)	ATS480		Circuit breaker (1) Q1 reference	Line contactor (2) KM1 reference	Bypass contactor (2) KM3 reference
		Class 10 Normal duty	Class 20 Heavy duty			
5.5	50	–	ATS480D17Y	GV4L25N	LC1D12●●	LC1D12●●
7.5	50	ATS480D17Y	ATS480D22Y	GV4L25N	LC1D18●●	LC1D18●●
11	50	ATS480D22Y	ATS480D32Y	GV4L25N	LC1D25●●	LC1D25●●
15	50	ATS480D32Y	ATS480D38Y	GV4L50N	LC1D40A●●	LC1D40A●●
18.5	50	ATS480D38Y	ATS480D47Y	GV4L50N	LC1D40A●●	LC1D40A●●
22	50	ATS480D47Y	ATS480D62Y	GV4L50N	LC1D40A●●	LC1D40A●●
30	50	ATS480D62Y	ATS480D75Y	GV4L80N	LC1D65A●●	LC1D65A●●
37	50	ATS480D75Y	ATS480D88Y	GV4L80N	LC1D65A●●	LC1D65A●●
45	50	ATS480D88Y	ATS480C11Y	GV4L80N	LC1D80●●	LC1D80●●
55	50	ATS480C11Y	ATS480C14Y	GV4L115N	LC1D115●●	LC1D115●●
75	50	ATS480C14Y	ATS480C17Y	NSX160N MA	LC1D150●●	LC1D150●●
90	50	ATS480C17Y	ATS480C21Y	NSX250N MA	LC1G150●●●●	LC1G150●●●●
110	50	ATS480C21Y	ATS480C25Y	NSX250N MA	LC1G185●●●●	LC1G185●●●●
132	50	ATS480C25Y	ATS480C32Y	NSX250N MA	LC1G225●●●●	LC1G225●●●●
160	50	ATS480C32Y	ATS480C41Y	NSX400H MicroLogic 1.3 M	LC1G265●●●●	LC1G265●●●●
220	70	ATS480C41Y	ATS480C48Y	NSX630S MicroLogic1.3 M	LC1G400●●●●	LC1G400●●●●
250	70	ATS480C48Y	ATS480C59Y	NSX630S MicroLogic 1.3 M	LC1G400●●●●	LC1G400●●●●
355	70	ATS480C59Y	ATS480C66Y	NS630bL MicroLogic 5.0 LR Off	LC1G630●●●●	LC1G630●●●●
400	70	ATS480C66Y	ATS480C79Y	NS630bL MicroLogic 5.0 LR Off	LC1G630●●●●	LC1G630●●●●
500	70	ATS480C79Y	ATS480M10Y	NS800L MicroLogic 5.0 LR Off	LC1G800●●●●	LC1G800●●●●
630	70	ATS480M10Y	ATS480M12Y	NS1000L MicroLogic 5.0 LR Off	LC1F1000●●	LC1F1000●●
710	42	ATS480M12Y	–	NS1250H MicroLogic 5.0 LR Off	LC1F2600●●	LC1F2600●●

500 V power supply, ATS480 connected in-line						
Motor power kW	Combination Iq (kA)	ATS480		Circuit breaker (1) Q1 reference	Line contactor (2) KM1 reference	Bypass contactor (2) KM3 reference
		Class 10 Normal duty	Class 20 Heavy duty			
7.5	50	–	ATS480D17Y	NSX100H MA	LC1D40A●●	LC1D40A●●
9	50	ATS480D17Y	ATS480D22Y	NSX100H MA	LC1D40A●●	LC1D40A●●
11	50	ATS480D22Y	ATS480D32Y	NSX100H MA	LC1D40A●●	LC1D40A●●
18.5	50	ATS480D32Y	ATS480D38Y	NSX100H MA	LC1D40A●●	LC1D40A●●
22	50	ATS480D38Y	ATS480D47Y	NSX100H MA	LC1D50A●●	LC1D50A●●
30	50	ATS480D47Y	ATS480D62Y	NSX100H MA	LC1D50A●●	LC1D50A●●
37	50	ATS480D62Y	ATS480D75Y	NSX100H MA	LC1D65A●●	LC1D65A●●
45	50	ATS480D75Y	ATS480D88Y	NSX100H MA	LC1D80●●	LC1D80●●
55	50	ATS480D88Y	ATS480C11Y	NSX100H MA	LC1D80●●	LC1D80●●
75	50	ATS480C11Y	ATS480C14Y	NSX160H MA	LC1D150●●	LC1D150●●
90	50	ATS480C14Y	ATS480C17Y	NSX160H MA	LC1D150●●	LC1D150●●
110	50	ATS480C17Y	ATS480C21Y	NSX250H MA	LC1G185●●●●	LC1G185●●●●
132	50	ATS480C21Y	ATS480C25Y	NSX250H MA	LC1G225●●●●	LC1G225●●●●
160	50	ATS480C25Y	ATS480C32Y	NSX400H MicroLogic 1.3 M	LC1G265●●●●	LC1G265●●●●
220	50	ATS480C32Y	ATS480C41Y	NSX630H MicroLogic 1.3 M	LC1G400●●●●	LC1G400●●●●
250	70	ATS480C41Y	ATS480C48Y	NSX630L MicroLogic 1.3 M	LC1G400●●●●	LC1G400●●●●
315	70	ATS480C48Y	ATS480C59Y	NSX630L MicroLogic 1.3 M	LC1G500●●●●	LC1G500●●●●
400	70	ATS480C59Y	ATS480C66Y	NS630bL MicroLogic 5.0 LR Off	LC1G800●●●●	LC1G800●●●●
450	70	ATS480C66Y	ATS480C79Y	NS800L MicroLogic 5.0 LR Off	LC1G800●●●●	LC1G800●●●●
500	42	ATS480C79Y	ATS480M10Y	NS800L MicroLogic 5.0 LR Off	LC1F2600●●	LC1F2600●●
630	42	ATS480M10Y	ATS480M12Y	NS1000L MicroLogic 5.0 LR Off	LC1F2600●●	LC1F2600●●
800	42	ATS480M12Y	–	NS1250H MicroLogic 5.0 LR Off	LC1F2600●●	LC1F2600●●

(1) Set I<sub>rm</sub> current of the circuit breaker (when available) to a minimum of six times the current rating of the soft starter.  
 (2) Replace with the appropriate control circuit voltage code (refer to page 44). ATS48 and ATS480 control supply voltage may differ, check the value in the installation guide before starting the system.

690 V power supply, ATS480 connected in-line						
Motor power kW	Combination I <sub>q</sub> (kA)	ATS480		Circuit breaker (1)	Line contactor (2)	Bypass contactor (2)
		Class 10 Normal duty	Class 20 Heavy duty	Q1 reference	KM1 reference	KM3 reference
11	50	–	ATS480D17Y	NSX100HB1 MA	LC1D40A●●	LC1D40A●●
15	50	ATS480D17Y	ATS480D22Y	NSX100HB1 MA	LC1D40A●●	LC1D40A●●
18.5	50	ATS480D22Y	ATS480D32Y	NSX100HB1 MA	LC1D40A●●	LC1D40A●●
22	50	ATS480D32Y	ATS480D38Y	NSX100HB1 MA	LC1D40A●●	LC1D40A●●
30	50	ATS480D38Y	ATS480D47Y	NSX100HB1 MA	LC1D40A●●	LC1D40A●●
37	50	ATS480D47Y	ATS480D62Y	NSX100HB1 MA	LC1D65A●●	LC1D65A●●
45	50	ATS480D62Y	ATS480D75Y	NSX100HB1 MA	LC1D80●●	LC1D80●●
55	50	ATS480D75Y	ATS480D88Y	NSX100HB1 MA	LC1D115●●	LC1D115●●
75	50	ATS480D88Y	ATS480C11Y	NSX100HB1 MA	LC1D115●●	LC1D115●●
90	15	ATS480C11Y	ATS480C14Y	NSX250HB1 MA	LC1D150●●	LC1D150●●
110	15	ATS480C14Y	ATS480C17Y	NSX250HB1 MA	LC1D150●●	LC1D150●●
160	50	ATS480C17Y	ATS480C21Y	NSX250HB1 MA	LC1G225●●●●	LC1G225●●●●
200	50	ATS480C21Y	ATS480C25Y	NSX400HB1 MicroLogic 1.3 M	LC1G265●●●●	LC1G265●●●●
250	50	ATS480C25Y	ATS480C32Y	NSX400HB1 MicroLogic 1.3 M	LC1G330●●●●	LC1G330●●●●
315	50	ATS480C32Y	ATS480C41Y	NSX630HB1 MicroLogic 1.3 M	LC1G400●●●●	LC1G400●●●●
400	70	ATS480C41Y	ATS480C48Y	NSX630HB1 MicroLogic 1.3 M	LC1G630●●●●	LC1G630●●●●
500	70	ATS480C48Y	ATS480C59Y	NS630bLB MicroLogic 5.0 LR Off	LC1G630●●●●	LC1G630●●●●
560	70	ATS480C59Y	ATS480C66Y	NS630bLB MicroLogic 5.0 LR Off	LC1G800●●●●	LC1G800●●●●
630	42	ATS480C66Y	ATS480C79Y	NS800LB MicroLogic 5.0 LR Off	LC1F2600●●	LC1F2600●●
710	42	ATS480C79Y	ATS480M10Y	NS800LB MicroLogic 5.0 LR Off	LC1F2600●●	LC1F2600●●
900	42	ATS480M10Y	ATS480M12Y	NS1000H MicroLogic 5.0 LR Off	LC1F2600●●	LC1F2600●●
950	42	ATS480M12Y	–	NS1250H MicroLogic 5.0 LR Off	LC1F2600●●	LC1F2600●●

(1) Set I<sub>rm</sub> current of the circuit breaker (when available) to a minimum of six times the current rating of the soft starter.

(2) Replace with the appropriate control circuit voltage code (refer to page 44). ATS48 and ATS480 control supply voltage may differ, check the value in the installation guide before starting the system.

230 V power supply, ATS480 connected in-line								
Motor power kW	I <sub>q</sub> (kA)	ATS480		Circuit breaker (1) Q1 reference	Line contactor Bypass contactor (2) KM1, KM3 reference	Fast-acting fuses with microswitch		Fuse disconnecter
		Class 10 Normal duty	Class 20 Heavy duty			FU reference	Size	
3	50	–	ATS480D17Y	GV2L20	LC1D25●●	DF3ER50	14 x 51	GK1EK
4	50	ATS480D17Y	ATS480D22Y	GV2L20	LC1D25●●	DF3ER50	14 x 51	GK1EK
5.5	50	ATS480D22Y	ATS480D32Y	GV2L22	LC1D25●●	DF3FR80	22 x 58	GS1JD3
7.5	50	ATS480D32Y	ATS480D38Y	GV2L32 + GV1L3	LC1D32●●	DF3FR80	22 x 58	GS1JD3
9	35	ATS480D38Y	ATS480D47Y	GV3L40	LC1D80●●	DF3FR100	22 x 58	GS1JD3
11	35	ATS480D47Y	ATS480D62Y	GV3L65	LC1D80●●	DF3FR100	22 x 58	GS1JD3
15	50	ATS480D62Y	ATS480D75Y	GV4L80B	LC1D65A●●	DF400125	00	GS1KKD3
18.5	50	ATS480D75Y	ATS480D88Y	GV4L80B	LC1D80●●	DF400125	00	GS1KKD3
22	50	ATS480D88Y	ATS480C11Y	GV4L115B	LC1D115●●	DF400160	00	GS1LLD3
30	50	ATS480C11Y	ATS480C14Y	GV4L115B	LC1D115●●	DF400160	00	–
37	50	ATS480C14Y	ATS480C17Y	NSX160F MA	LC1D150●●	DF430400	30	–
45	50	ATS480C17Y	ATS480C21Y	NSX250F MA	LC1G185●●●●	DF430400	30	–
55	50	ATS480C21Y	ATS480C25Y	NSX250F MA	LC1G225●●●●	DF431700	31	–
75	50	ATS480C25Y	ATS480C32Y	NSX400F MicroLogic 1.3 M	LC1G265●●●●	DF431700	31	–
90	50	ATS480C32Y	ATS480C41Y	NSX400F MicroLogic 1.3 M	LC1G330●●●●	DF431700	31	–
110	50	ATS480C41Y	ATS480C48Y	NSX630F MicroLogic 1.3 M	LC1G400●●●●	DF433800	33	–
132	50	ATS480C48Y	ATS480C59Y	NSX630F MicroLogic 1.3 M	LC1G500●●●●	DF4331000	33	–
160	50	ATS480C59Y	ATS480C66Y	NS630bN MicroLogic 5.0 LR Off	LC1G630●●●●	DF4331000	33	–
200	50	ATS480C66Y	ATS480C79Y	NS800N MicroLogic 5.0 LR Off	LC1G630●●●●	DF42331400	2 x 33	–
220	50	ATS480C79Y	ATS480M10Y	NS800N MicroLogic 5.0 LR Off	LC1G800●●●●	DF4441600	44	–
250	85	ATS480M10Y	ATS480M12Y	NS1000N MicroLogic 5.0 LR Off	LC1F1000●●	DF4442200	44	–
355	85	ATS480M12Y	–	NS1250N MicroLogic 5.0 LR Off	LC1F2600●● (3)	DF4442200	44	–

230 V power supply, ATS480 connected inside delta								
Motor power kW	I <sub>q</sub> (kA)	ATS480		Circuit breaker (1) Q1 reference	Line contactor Bypass contactor (2) KM1, KM3 reference	Fast-acting fuses		Fuse-disconnector
		Class 10 Normal duty	Class 20 Heavy duty			FU reference	Size	
5.5	50	–	ATS480D17Y	GV2L22	LC1D25●●	DF3ER50	14 x 51	GK1EK
7.5	50	ATS480D17Y	ATS480D22Y	GV2L32 + GV1L3	LC1D32●●	DF3ER50	14 x 51	GK1EK
9	35	ATS480D22Y	ATS480D32Y	GV3L40	LC1D80●●	DF3FR80	22 x 58	GS1JD3
15	50	ATS480D32Y	ATS480D38Y	GV4L80B	LC1D65A●●	DF3FR80	22 x 58	GS1JD3
18.5	50	ATS480D38Y	ATS480D47Y	GV4L80B	LC1D80●●	DF3FR100	22 x 58	GS1JD3
22	50	ATS480D47Y	ATS480D62Y	GV4L115B	LC1D115●●	DF3FR100	22 x 58	GS1JD3
30	50	ATS480D62Y	ATS480D75Y	GV4L115B	LC1D115●●	DF400125	00	GS1KKD3
37	50	ATS480D75Y	ATS480D88Y	NSX160F MA	LC1D150●●	DF400125	00	GS1KKD3
45	50	ATS480D88Y	ATS480C11Y	NSX250F MA	LC1G185●●●●	DF400160	00	GS1LLD3
55	50	ATS480C11Y	ATS480C14Y	NSX250F MA	LC1G225●●●●	DF400160	00	–
75	50	ATS480C14Y	ATS480C17Y	NSX400F MicroLogic 1.3 M	LC1G265●●●●	DF430400	30	–
90	50	ATS480C17Y	ATS480C21Y	NSX400F MicroLogic 1.3 M	LC1G330●●●●	DF430400	30	–
110	50	ATS480C21Y	ATS480C25Y	NSX630F MicroLogic 1.3 M	LC1G400●●●●	DF431700	31	–
132	50	ATS480C25Y	ATS480C32Y	NSX630F MicroLogic 1.3 M	LC1G500●●●●	DF431700	31	–
160	50	ATS480C32Y	ATS480C41Y	NS630bN MicroLogic 5.0 LR Off	LC1G630●●●●	DF431700	31	–
220	50	ATS480C41Y	ATS480C48Y	NS800N MicroLogic 5.0 LR Off	LC1G800●●●●	DF433800	43	–
250	85	ATS480C48Y	ATS480C59Y	NS1000N MicroLogic 5.0 LR Off	LC1F1000●●	DF4331000	43	–
355	85	ATS480C79Y	ATS480M10Y	NS1250N MicroLogic 5.0 LR Off	LC1F2600●● (3)	DF4442200	44	–

(1) Set I<sub>rm</sub> current of the circuit breaker (when available) to a minimum of six times the current rating of the soft starter.  
(2) Replace with the appropriate control circuit voltage code (refer to page 44). ATS48 and ATS480 control supply voltage may differ, check the value in the installation guide before starting the system.  
(3) Type 2 coordination is only possible if the fast-acting fuses remain in the motor supply circuit and are not bypassed at the end of starting.

380/400/415 V power supply, ATS480 connected in-line								
Motor power kW	I <sub>q</sub> (kA)	ATS480		Circuit breaker (1) Q1 reference	Line contactor Bypass contactor (2) KM1, KM3 reference	Fast-acting fuses		Fuse-disconnector
		Class 10 Normal duty	Class 20 Heavy duty			FU reference	Size	
5.5	50	–	ATS480D17Y	GV2L20	LC1D25●●	DF3ER50	14 x 51	GK1EK
7.5	50	ATS480D17Y	ATS480D22Y	GV2L20	LC1D25●●	DF3ER50	14 x 51	GK1EK
11	40	ATS480D22Y	ATS480D32Y	GV2L22	LC1D25●●	DF3FR80	22 x 58	GS1JD3
15	40	ATS480D32Y	ATS480D38Y	GV2L32 + GV1L3	LC1D32●●	DF3FR80	22 x 58	GS1JD3
18.5	40	ATS480D38Y	ATS480D47Y	GV3L40	LC1D50A●●	DF3FR100	22 x 58	GS1JD3
22	40	ATS480D47Y	ATS480D62Y	GV3L50	LC1D50A●●	DF3FR100	22 x 58	GS1JD3
30	50	ATS480D62Y	ATS480D75Y	GV3L65	LC1D65A●●	DF400125	00	GS1KKD3
37	50	ATS480D75Y	ATS480D88Y	GV4L80N	LC1D80●●	DF400125	00	GS1KKD3
45	50	ATS480D88Y	ATS480C11Y	GV4L115N	LC1D115●●	DF400160	00	GS1LLD3
55	50	ATS480C11Y	ATS480C14Y	GV4L115N	LC1D115●●	DF400160	00	–
75	50	ATS480C14Y	ATS480C17Y	NSX160N MA	LC1D150●●	DF430400	30	–
90	50	ATS480C17Y	ATS480C21Y	NSX250N MA	LC1G185●●●●	DF430400	30	–
110	50	ATS480C21Y	ATS480C25Y	NSX250N MA	LC1G225●●●●	DF431700	31	–
132	50	ATS480C25Y	ATS480C32Y	NSX400N MicroLogic 1.3 M	LC1G265●●●●	DF431700	31	–
160	50	ATS480C32Y	ATS480C41Y	NSX400N MicroLogic 1.3 M	LC1G330●●●●	DF431700	31	–
220	50	ATS480C41Y	ATS480C48Y	NSX630N MicroLogic 1.3 M	LC1G500●●●●	DF433800	33	–
250	50	ATS480C48Y	ATS480C59Y	NSX630N MicroLogic 1.3 M	LC1G500●●●●	DF4331000	33	–
315	50	ATS480C59Y	ATS480C66Y	NS630bN MicroLogic 5.0 LR Off	LC1G630●●●●	DF4331000	33	–
355	50	ATS480C66Y	ATS480C79Y	NS800N MicroLogic 5.0 LR Off	LC1G630●●●●	DF42331400	2 x 33	–
400	50	ATS480C79Y	ATS480M10Y	NS800N MicroLogic 5.0 LR Off	LC1G800●●●●	DF4441600	44	–
500	85	ATS480M10Y	ATS480M12Y	NS1000N MicroLogic 5.0 LR Off	LC1F1000●●	DF4442200	44	–
630	85	ATS480M12Y	–	NS1250N MicroLogic 5.0 LR Off	LC1F2600●● (3)	DF4442200	44	–

380/400/415 V power supply, ATS480 connected inside delta								
Motor power kW	I <sub>q</sub> (kA)	ATS480		Circuit breaker (1) Q1 reference	Line contactor Bypass contactor (2) KM1, KM3 reference	Fast-acting fuses		Fuse-disconnector
		Class 10 Normal duty	Class 20 Heavy duty			FU reference	Size	
11	40	–	ATS480D17Y	GV2L22	LC1D25●●	DF3ER50	14 x 51	GK1EK
15	40	ATS480D17Y	ATS480D22Y	GV2L32 + GV1L3	LC1D32●●	DF3ER50	14 x 51	GK1EK
18.5	40	ATS480D22Y	ATS480D32Y	GV3L40	LC1D50A●●	DF3FR80	22 x 58	GS1JD3
22	40	ATS480D32Y	ATS480D38Y	GV3L50	LC1D50A●●	DF3FR80	22 x 58	GS1JD3
30	50	ATS480D38Y	ATS480D47Y	GV3L65	LC1D65A●●	DF3FR100	22 x 58	GS1JD3
45	50	ATS480D47Y	ATS480D62Y	GV4L115N	LC1D115●●	DF3FR100	22 x 58	GS1JD3
55	50	ATS480D62Y	ATS480D75Y	GV4L115N	LC1D115●●	DF400125	00	GS1KKD3
55	50	ATS480D75Y	ATS480D88Y	GV4L115N	LC1D115●●	DF400125	00	GS1KKD3
75	50	ATS480D88Y	ATS480C11Y	NSX160N MA	LC1D150●●	DF400160	00	GS1LLD3
90	50	ATS480C11Y	ATS480C14Y	NSX250N MA	LC1G185●●●●	DF400160	00	–
110	50	ATS480C14Y	ATS480C17Y	NSX250N MA	LC1G225●●●●	DF430400	30	–
132	50	ATS480C17Y	ATS480C21Y	NSX400N MicroLogic 1.3 M	LC1G265●●●●	DF430400	30	–
160	50	ATS480C21Y	ATS480C25Y	NSX400N MicroLogic 1.3 M	LC1G330●●●●	DF431700	31	–
220	50	ATS480C25Y	ATS480C32Y	NSX630N MicroLogic 1.3 M	LC1G500●●●●	DF431700	31	–
250	50	ATS480C32Y	ATS480C41Y	NSX630N MicroLogic 1.3 M	LC1G500●●●●	DF431700	31	–
315	50	ATS480C41Y	ATS480C48Y	NS630bN MicroLogic 5.0 LR Off	LC1G630●●●●	DF433800	33	–
355	50	ATS480C48Y	ATS480C59Y	NS800N MicroLogic 5.0 LR Off	LC1G630●●●●	DF4331000	33	–
400	50	ATS480C59Y	ATS480C66Y	NS800N MicroLogic 5.0 LR Off	LC1G800●●●●	DF4331000	33	–
500	50	ATS480C66Y	ATS480C79Y	NS1000N MicroLogic 5.0 LR Off	LC1F1000●●	DF42331400	2 x 33	–
630	85	ATS480C79Y	ATS480M10Y	NS1250N MicroLogic 5.0 LR Off	LC1F2600●● (3)	DF4442200	44	–

(1) Set I<sub>rm</sub> current of the circuit breaker (when available) to a minimum of six times the current rating of the soft starter.

(2) Replace with the appropriate control circuit voltage code (refer to page 44). ATS48 and ATS480 control supply voltage may differ, check the value in the installation guide before starting the system.

(3) Type 2 coordination is only possible if the fast-acting fuses remain in the motor supply circuit and are not bypassed at the end of starting.

440 V power supply, ATS480 connected in-line								
Motor power kW	I <sub>q</sub> (kA)	ATS480		Circuit breaker (1) Q1 reference	Line contactor Bypass contactor (2) KM1, KM3 reference	Fast-acting fuses		Fuse- disconnecter
		Class 10 Normal duty	Class 20 Heavy duty			FU reference	Size	
5.5	50	–	ATS480D17Y	GV4L25N	LC1D65A●●	DF3ER50	14 x 51	GK1EK
7.5	50	ATS480D17Y	ATS480D22Y	GV4L25N	LC1D65A●●	DF3ER50	14 x 51	GK1EK
11	20	ATS480D22Y	ATS480D32Y	GV4L25N	LC1D65A●●	DF3FR80	22 x 58	GS1JD3
15	20	ATS480D32Y	ATS480D38Y	GV4L50N	LC1D65A●●	DF3FR80	22 x 58	GS1JD3
18.5	20	ATS480D38Y	ATS480D47Y	GV4L50N	LC1D65A●●	DF3FR100	22 x 58	GS1JD3
22	20	ATS480D47Y	ATS480D62Y	GV4L50N	LC1D65A●●	DF3FR100	22 x 58	GS1JD3
30	50	ATS480D62Y	ATS480D75Y	GV4L80N	LC1D65A●●	DF400125	00	GS1KKD3
37	50	ATS480D75Y	ATS480D88Y	GV4L80N	LC1D65A●●	DF400125	00	GS1KKD3
45	40	ATS480D88Y	ATS480C11Y	GV4L80N	LC1D80●●	DF400160	00	GS1LLD3
55	40	ATS480C11Y	ATS480C14Y	GV4L115N	LC1D115●●	DF400160	00	–
75	50	ATS480C14Y	ATS480C17Y	NSX160N MA	LC1D150●●	DF430400	30	–
90	50	ATS480C17Y	ATS480C21Y	NSX250N MA	LC1G150●●●●	DF430400	30	–
110	50	ATS480C21Y	ATS480C25Y	NSX250N MA	LC1G185●●●●	DF431700	31	–
132	50	ATS480C25Y	ATS480C32Y	NSX400 MA	LC1G225●●●●	DF431700	31	–
160	50	ATS480C32Y	ATS480C41Y	NSX400N MicroLogic 1.3 M	LC1G265●●●●	DF431700	31	–
220	50	ATS480C41Y	ATS480C48Y	NSX630H MicroLogic 1.3 M	LC1G400●●●●	DF433800	33	–
250	50	ATS480C48Y	ATS480C59Y	NSX630H MicroLogic 1.3 M	LC1G400●●●●	DF4331000	33	–
355	50	ATS480C59Y	ATS480C66Y	NS630bN MicroLogic 5.0 LR Off	LC1G630●●●●	DF4331000	33	–
400	50	ATS480C66Y	ATS480C79Y	NS800N MicroLogic 5.0 LR Off	LC1G630●●●●	DF42331400	2 x 33	–
500	50	ATS480C79Y	ATS480M10Y	NS800N MicroLogic 5.0 LR Off	LC1G800●●●●	DF4441600	44	–
630	85	ATS480M10Y	ATS480M12Y	NS1000N MicroLogic 5.0 LR Off	LC1F1000●●	DF4442200	44	–
710	85	ATS480M12Y	–	NS1250N MicroLogic 5.0 LR Off	LC1F2600●● (3)	DF4442200	44	–

500 V power supply, ATS480 connected in-line								
Motor power kW	I <sub>q</sub> (kA)	ATS480		Circuit breaker (1) Q1 reference	Line contactor Bypass contactor (2) KM1, KM3 reference	Fast-acting fuses		Fuse- disconnecter
		Class 10 Normal duty	Class 20 Heavy duty			FU reference	Size	
7.5	50	–	ATS480D17Y	GV2L20 + LA9LB920	LC1D25●●	DF3ER50	14 x 51	GK1EK
9	50	ATS480D17Y	ATS480D22Y	GV2L20 + LA9LB920	LC1D25●●	DF3ER50	14 x 51	GK1EK
11	20	ATS480D22Y	ATS480D32Y	GV2L20 + LA9LB920	LC1D25●●	DF3FR80	22 x 58	GS1JD3
18.5	20	ATS480D32Y	ATS480D38Y	GV2L32 + LA9LB920	LC1D25●●	DF3FR80	22 x 58	GS1JD3
22	20	ATS480D38Y	ATS480D47Y	NSX100H MA	LC1D80●●	DF3FR100	22 x 58	GS1JD3
30	20	ATS480D47Y	ATS480D62Y	NSX100H MA	LC1D80●●	DF3FR100	22 x 58	GS1JD3
37	50	ATS480D62Y	ATS480D75Y	NSX100H MA	LC1D150●●	DF400125	00	GS1KKD3
45	50	ATS480D75Y	ATS480D88Y	NSX100H MA	LC1D150●●	DF400125	00	GS1KKD3
55	40	ATS480D88Y	ATS480C11Y	NSX100H MA	LC1D150●●	DF400160	00	GS1LLD3
75	50	ATS480C11Y	ATS480C14Y	NSX160H MA	LC1D150●●	DF400160	00	–
90	50	ATS480C14Y	ATS480C17Y	NSX160H MA	LC1G185●●●●	DF430400	30	–
110	50	ATS480C17Y	ATS480C21Y	NSX160H MA	LC1G185●●●●	DF430400	30	–
132	50	ATS480C21Y	ATS480C25Y	NSX250H MA	LC1G225●●●●	DF431700	31	–
160	50	ATS480C25Y	ATS480C32Y	NSX400H MicroLogic 1.3 M	LC1G265●●●●	DF431700	31	–
220	50	ATS480C32Y	ATS480C41Y	NSX400H MicroLogic 1.3 M	LC1G400●●●●	DF431700	31	–
250	40	ATS480C41Y	ATS480C48Y	NSX630H MicroLogic 1.3 M	LC1G400●●●●	DF433800	33	–
315	50	ATS480C48Y	ATS480C59Y	NSX630H MicroLogic 1.3 M	LC1G500●●●●	DF4331000	33	–
400	50	ATS480C59Y	ATS480C66Y	NS630bH MicroLogic 5.0 LR Off	LC1G800●●●●	DF4331000	33	–
450	50	ATS480C66Y	ATS480C79Y	NS800H MicroLogic 5.0 LR Off	LC1G800●●●●	DF42331400	2 x 33	–
500	50	ATS480C79Y	ATS480M10Y	NS800H MicroLogic 5.0 LR Off	LC1F1000●●	DF4441600	44	–
630	85	ATS480M10Y	ATS480M12Y	NS1000H MicroLogic 5.0 LR Off	LC1F2600●● (3)	DF4442200	44	–
800	85	ATS480M12Y	–	NS1250H MicroLogic 5.0 LR Off	LC1F2600●● (3)	DF4442200	44	–

(1) Set I<sub>rm</sub> current of the circuit breaker (when available) to a minimum of six times the current rating of the soft starter.

(2) Replace with the appropriate control circuit voltage code (refer to page 44). ATS48 and ATS480 control supply voltage may differ, check the value in the installation guide before starting the system.

(3) Type 2 coordination is only possible if the fast-acting fuses remain in the motor supply circuit and are not bypassed at the end of starting.

690 V power supply, ATS480 connected in-line								
Motor power kW	I <sub>q</sub> (kA)	ATS480		Circuit breaker (1) Q1 reference	Line contactor Bypass contactor (2) KM1, KM3 reference	Fast-acting fuses		Fuse- disconnecter
		Class 10 Normal duty	Class 20 Heavy duty			FU reference	Size	
11	50	–	ATS480D17Y	NSX100HB1 MA	LC1D80●●	DF3ER50	14 x 51	GK1EK
15	50	ATS480D17Y	ATS480D22Y	NSX100HB1 MA	LC1D80●●	DF3ER50	14 x 51	GK1EK
18.5	20	ATS480D22Y	ATS480D32Y	NSX100HB1 MA	LC1D80●●	DF3FR80	22 x 58	GS1JD3
22	20	ATS480D32Y	ATS480D38Y	NSX100HB1 MA	LC1D80●●	DF3FR80	22 x 58	GS1JD3
30	20	ATS480D38Y	ATS480D47Y	NSX100HB1 MA	LC1D150●●	DF3FR100	22 x 58	GS1JD3
37	20	ATS480D47Y	ATS480D62Y	NSX100HB1 MA	LC1D150●●	DF3FR100	22 x 58	GS1JD3
45	25	ATS480D62Y	ATS480D75Y	NSX100HB1 MA	LC1D150●●	DF400125	00	GS1KKD3
55	25	ATS480D75Y	ATS480D88Y	NSX100HB1 MA	LC1D150●●	DF400125	00	GS1KKD3
75	40	ATS480D88Y	ATS480C11Y	NSX100HB1 MA	LC1D150●●	DF400160	00	GS1LLD3
90	50	ATS480C11Y	ATS480C14Y	NSX250HB1 MA	LC1G185●●●●	DF400160	00	–
110	50	ATS480C14Y	ATS480C17Y	NSX250HB1 MA	LC1G225●●●●	DF430400	30	–
160	50	ATS480C17Y	ATS480C21Y	NSX250HB1 MA	LC1G225●●●●	DF430400	30	–
200	50	ATS480C21Y	ATS480C25Y	NSX250HB1 MA	LC1G265●●●●	DF431700	31	–
250	50	ATS480C25Y	ATS480C32Y	NSX400HB1 MicroLogic 1.3 M	LC1G330●●●●	DF431700	31	–
315	50	ATS480C32Y	ATS480C41Y	NSX630HB1 MicroLogic 1.3 M	LC1G400●●●●	DF431700	31	–
400	40	ATS480C41Y	ATS480C48Y	NSX630HB1 MicroLogic 1.3 M	LC1G630●●●●	DF433800	33	–
500	50	ATS480C48Y	ATS480C59Y	NS630bLB MicroLogic 5.0 LR Off	LC1G630●●●●	DF4331000	33	–
560	50	ATS480C59Y	ATS480C66Y	NS630bLB MicroLogic 5.0 LR Off	LC1G800●●●●	DF4331000	33	–
630	50	ATS480C66Y	ATS480C79Y	NS800LB MicroLogic 5.0 LR Off	LC1F2600●● (3)	DF42331400	2 x 33	–
710	50	ATS480C79Y	ATS480M10Y	NS800LB MicroLogic 5.0 LR Off	LC1F2600●● (3)	DF4441600	44	–
900	42	ATS480M10Y	ATS480M12Y	NS1000H MicroLogic 5.0 LR Off	LC1F2600●● (3)	DF4442200	44	–
950	42	ATS480M12Y	–	NS1250H MicroLogic 5.0 LR Off	LC1F2600●● (3)	DF4442200	44	–

(1) Set I<sub>rm</sub> current of the circuit breaker (when available) to a minimum of six times the current rating of the soft starter.

(2) Replace with the appropriate control circuit voltage code (refer to page 44). ATS48 and ATS480 control supply voltage may differ, check the value in the installation guide before starting the system.

(3) Type 2 coordination is only possible if the fast-acting fuses remain in the motor supply circuit and are not bypassed at the end of starting.

## Line contactor reference table

Basic reference	Power supply	Control voltage code													
		24	42	48	110	115	220	230	240	380	400	415	440	500	
LC1D18...D150 (1)	50/60 Hz	B7	D7	E7	F7	FE7	M7	P7	U7	Q7	V7	N7	R7	S7	
LC1D18...D65 (2)	50 Hz	B5	D5	E5	-	-	-	P5	-	-	-	-	-	-	
LC1D80...D115	50 Hz	B5	D5	E5	F5	FE5	M5	P5	U5	Q5	V5	N5	R5	S5	
LC1D80...D115	60 Hz	B6	-	E6	F6	-	M6	-	U6	Q6	-	-	R6	-	
	DC	12	24	36	48	60	72	110	125	220	250	440			
LC1D18...D38 (3)	U 0.7...1.25 Uc	JD	BD	CD	ED	ND	SD	FD	GD	MD	UD	RD			
LC1D40A...D65A (3)	U 0.75...1.25 Uc	JD	(5)	(5)	(5)	(5)	(5)	(5)	(5)	(5)	(5)	RD			
LC1D80...D95	U 0.85...1.1 Uc	JD	BD	CD	ED	ND	SD	FD	GD	MD	UD	RD			
	U 0.75...1.2 Uc	JW	BW	CW	EW	-	SW	FW	-	MW	-	-			
LC1D115...150 (4)	U 0.75...1.2 Uc	-	BD	-	ED	ND	SD	FD	GD	MD	UD	RD			
	DC (low consumption)	5	12	20	24	48	110	220	250						
LC1D18...D38 (3)	U 0.8...1.25 Uc	AL	JL	ZL	BL	EL	FL	ML	UL						
	AC/DC (low consumption)														
LC1D18...D150	See TeSys D Green, page B8/4 of <a href="#">TeSys catalog</a>														
	AC	24	48	110	115	120	208	220	230	240	380	400	415	440	
LC1F1000...2600	40...400 Hz (coil LX1F)	-	-	F7	-	G7	-	M7	P7	U7	Q7	V7	N7	R7	
	DC	24	48	110	125	220	230	250	400	440					
LC1F1000...2600	(coil LX4F)	-	-	FD	GD	MD	-	UD	-	RD					
	AC/DC	24...48	48...130	100...250	200...500										
LC1G150...G500		BEEA		EHEN		KUEN		LSEA							
LC1G630...G800		-		EHEN		KUEN		LSEA							

(1) D115 and D150 coils with built-in suppression as standard, by bidirectional peak limiting diode.

(2) Not available with «connection for lugs or bars».

(3) Coils with integral suppression device fitted as standard, by bidirectional peak limiting diode.

(4) Coil with built-in suppression device as standard.

(5) For these coil voltages, choose from TeSys D Green contactors. Same product reference radical, just add BBE coil voltage code for 24 V DC, BNE for 24-60 V AC/DC, EHE for 48-130 V AC/DC, KUE for 100-250 V AC/DC. Example: LC1D40ABBE

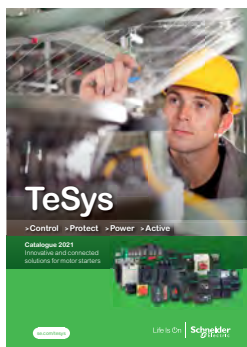

# Altivar Soft Starter ATS480

Soft starters for asynchronous motors  
Soft starters

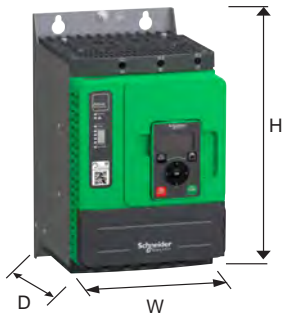

Soft starters		
Overall dimensions		
Reference	W x H x D	
	mm	in.
ATS480D17Y	160 x 275 x 203	6.30 x 10.83 x 7.99
ATS480D22Y	160 x 275 x 203	6.30 x 10.83 x 7.99
ATS480D32Y	160 x 275 x 203	6.30 x 10.83 x 7.99
ATS480D38Y	160 x 275 x 203	6.30 x 10.83 x 7.99
ATS480D47Y	160 x 275 x 203	6.30 x 10.83 x 7.99
ATS480D62Y	190 x 290 x 247	7.48 x 11.42 x 9.72
ATS480D75Y	190 x 290 x 247	7.48 x 11.42 x 9.72
ATS480D88Y	190 x 290 x 247	7.48 x 11.42 x 9.72
ATS480C11Y	190 x 290 x 247	7.48 x 11.42 x 9.72
ATS480C14Y	200 x 340 x 272	7.87 x 13.39 x 10.71
ATS480C17Y	200 x 340 x 272	7.87 x 13.39 x 10.71
ATS480C21Y	320 x 380 x 277	12.60 x 14.96 x 10.91
ATS480C25Y	320 x 380 x 277	12.60 x 14.96 x 10.91
ATS480C32Y	320 x 380 x 277	12.60 x 14.96 x 10.91
ATS480C41Y	400 x 670 x 314	15.75 x 26.38 x 12.36
ATS480C48Y	400 x 670 x 314	15.75 x 26.38 x 12.36
ATS480C59Y	400 x 670 x 314	15.75 x 26.38 x 12.36
ATS480C66Y	400 x 670 x 314	15.75 x 26.38 x 12.36
ATS480C79Y	770 x 890 x 329	30.31 x 35.04 x 12.95
ATS480M10Y	770 x 890 x 329	30.31 x 35.04 x 12.95
ATS480M12Y	770 x 890 x 329	30.31 x 35.04 x 12.95



# Altivar Soft Starter ATS480

Soft starters for asynchronous motors  
Line chokes

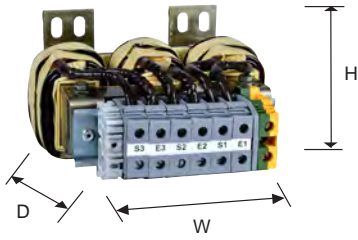

## Line chokes

### Overall dimensions

Reference	W x H x D	
	mm	in.
VZ1L015UM17T	130 x 155 x 80	5.12 x 6.10 x 3.15
VZ1L030U800T	155 x 170 x 120	6.10 x 6.69 x 4.72
VZ1L040U600T	175 x 200 x 130	6.89 x 7.87 x 5.12
VZ1L070U350T	180 x 200 x 150	7.09 x 7.87 x 5.91
VZ1L150U170T	270 x 234 x 147	10.63 x 9.21 x 5.79
VZ1L250U100T	270 x 237 x 190	10.63 x 9.33 x 7.48
VZ1L325U075T	300 x 260 x 206	11.81 x 10.24 x 8.11
VZ1L530U045T	380 x 415 x 225	14.96 x 16.34 x 8.86
VZ1LM10U024T	455 x 420 x 300	17.91 x 16.54 x 11.81
VZ1LM14U016T	400 x 490 x 330	15.75 x 19.29 x 12.99

# Variable speed drives and soft starters

A whole world of Services for your drives and soft starters by Schneider Electric

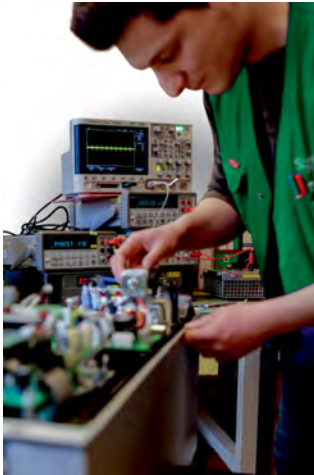

## Support and services offer by Schneider Electric

Variable speed drives and soft starters are an important part of your operation, with downtime having a significant impact on your business. Protecting that investment through comprehensive services means that you can continue to deliver optimally throughout the lifecycle of your drive and soft starter. Our range of services is designed to help you get more out of your drives and soft starters, your operation, and to improve your environmental impact.



### Install

- **Extended Warranty** service helps you control your maintenance costs. Schneider Electric will provide a replacement drive and soft starter or repair the product on site during a period of one or three years more than the standard warranty, in all conditions covered by the extended warranty.
- **Start-up** service is the first essential step in maintenance and optimal operational performance of the drive or soft starter. Our comprehensive review checks up to 100 parameters and is especially designed for drives and soft starters in simple applications.
- **Commissioning** service ensures a reliable start for operations with more complex applications and drive systems. The unique requirements of your process need to be carefully considered to ensure efficient operations.

### Operate

- **Preventive Maintenance** service performs predetermined maintenance actions according to a product-specific schedule. The work is carried out by certified technical experts following Schneider Electric instructions. This service minimizes unplanned downtime and extends your equipment lifetime.
- **Remote Technical Support** brings you expert product assistance over the phone, email, chat, or web for any technical questions relating to your drives and soft starters, including configuration, diagnostics, and maintenance. Our global support team is multi-lingual with support available up to R&D level experts if needed.
- **On-Site Expert Assistance** service offers you highly skilled field service experts to troubleshoot and resolve drive or soft starter equipment-related matters at your site, as a back-up source of expertise for your personnel.
- **Spare Part Management** service identifies and manages your critical spare parts either on your site or offsite. This service ensures that you have access to the spares you need without having to invest in capital to maintain the stock.

(1) Services available in countries that have the right structure and capabilities.

# Variable speed drives and soft starters

A whole world of Services for your drives and soft starters by Schneider Electric



## Support and services offer by Schneider Electric (continued)

### Optimize

- **Training** service offers eLearning, classroom, and onsite training provision to enhance the technical installation, commissioning, and maintenance competencies of your personnel. Added competence translates into further process efficiency and reliability, as well as employee satisfaction.
- **EcoStruxure Asset Advisor** service enables you to move from reactive to predictive maintenance and access actionable insight provided by the advisor. The service predicts drive- and motor-related actions through connected devices and advanced algorithms monitored by Schneider Electric's experts.

### Renew

- **Drive Revitalization** is an excellent choice if you prefer to use your aging drives longer and want to extend their service life with affordable and comprehensive inspection and replacement of all critical parts.
- **Drive and soft starter replacement** involves modernizing equipment by replacing the previous aged or obsolete product with a new one matched to the purpose. The service can be extended with engineering in case the device and process requires more advanced engineering.

### Circular economy

- **Spare Parts** are available from our local, regional, and global stocks. Original equipment parts from Schneider Electric are reliable and easily available. They will help to keep your product in operation for longer.
- **Repair** allows you to extend the life of your drive or soft starter. The affected product can be replaced, or repaired on site or at our repair centers, depending on the type of product in question.
- **Fast Exchange by refurbished drive or soft starter (1)** gives a second life to inoperative drives or soft starters. In this case, we offer an immediate exchange with a replacement refurbished drive or soft starter and take back the product, repair it, and keep it ready for the next exchange.
- **Take-back and recycling (1)** is the last step to improve your environmental impact. Unrepairable products are dismantled, raw materials are collected and given a second life. Up to 85% of the product components can be recycled.

## Service contracts secure recovery, availability, and outcome

**Service contracts** manage the safety and performance of your assets through well-defined maintenance plans tailored to your operational needs. The predefined service contract – Advantage Service Plan – and fully customizable “à la carte” service contract are built from the services in the “Operate” and “Optimize” phases and service levels defining availability, response, and lead times matching your particular needs. You will enjoy priority access to Schneider Electric support when you need it, as well as having an expert partner to plan the long-term evolution of your drives and soft starters.

## mySchneider app

With the mySchneider app you have easy 24/7 access to product information and expert support. All registered users have access to additional features, such as real-time notifications, order tracking, product pricing, and availability. The mySchneider app is available for download from the IOS and Android app store.

## Schneider Electric – helping you succeed

Schneider Electric, the leader in digital transformation of energy management and automation, has operations in more than 100 countries. With this global footprint we have certified field service representatives, regional expert and advanced level support up to product R&D to provide you the right support across the lifecycle of your drives and soft starters. Furthermore, we offer an extensive network of local and global repair centers and a logistics chain that underpins our ability to respond to your needs.

To order services or find out more, please contact your local Schneider Electric service center.

(1) Services available in countries that have the right structure and capabilities.

# Altivar Soft Starter ATS480

## Soft starters for asynchronous motors

### Product reference index

<b>#</b>									
490NTC00005	29	ATS480D62Y	18	GS1JD3	40	TSXCANCADD03	31	VZ1L015UM17T	27
490NTC00015	29		27		41	TSXCANCADD1	31		32
490NTW00002	29		36		42	TSXCANCB100	30		46
490NTW00002U	29		45		43	TSXCANCB300	30	VZ1L030U800T	27
490NTW00005	29	ATS480D75Y	18	GS1KKD3	40	TSXCANCB50	30		32
490NTW00005U	29		27		41	TSXCANCBDD3	31		46
490NTW00012	29		36		42	TSXCANCBDD5	31	VZ1L040U600T	27
490NTW00012U	29		45		43	TSXCANCD100	30		32
		ATS480D88Y	18	GS1LLD3	40	TSXCANCD300	30		46
			27		41	TSXCANCD50	30	VZ1L070U350T	27
			36		42	TSXCANKCDF180T	30		32
			45		43	TSXCANTDM4	31		46
		ATS480M10Y	18	GV1L3	40			VZ1L150U170T	27
ATS480C11Y	18		27		41				32
	27		36		41				46
	36		45		41			VZ1L250U100T	27
	45	ATS480M12Y	18	GV2L20	36	<b>V</b>			32
ATS480C14Y	18		27		37	VW3A1104R10	23		46
	27		36		40		25	VZ1L325U075T	27
	36		45		41	VW3A1104R100	23		32
	45				42		25		46
ATS480C17Y	18	<b>D</b>		GV2L22	36	VW3A1104R30	23	VZ1L530U045T	27
	27	DF3ER50	40		37		25		32
	36		41		40	VW3A1104R50	23		46
	45		42	GV2L32	36		25	VZ1LM10U024T	27
			43		37	VW3A1104R50	23		32
ATS480C21Y	18		43		40	VW3A1105	34	VZ1LM14U016T	27
	27	DF3FR100	40		41	VW3A1111	24		32
	36		41		42	VW3A1112	25		46
	45		42	GV3L40	36	VW3A1113	22		
ATS480C25Y	18		43		37	VW3A1114	23	VZ3V481	21
	27	DF3FR80	40		40	VW3A1114	23	VZ3V4811	21
	36		41		41	VW3A3607	27	VZ3V482	21
	45		42	GV3L50	41	VW3A3607	31	VZ3V483	21
ATS480C32Y	18		43		41	VW3A3608	27	VZ3V484	21
	27	DF400125	40	GV3L65	36		30	VZ3V485	21
	36		41		37	VW3A3618	27		
	45		42		40		30	<b>Z</b>	
			43	GV4L115B	36	VW3A3628	27	ZB5AZ905	23
ATS480C41Y	18	DF400160	40		40		31		25
	27		41	GV4L115N	38	VW3A3647	27		
	36		42		41		31		
	45		43		42	VW3A3720	27		
ATS480C48Y	18	DF42331400	40	GV4L25N	38		29		
	27		41		42	VW3A8127	34		
	36		42	GV4L50N	38	VW3A8306R	28		
	45		43		42	VW3A8306R03	25		
ATS480C59Y	18	DF430400	40	GV4L80B	36		28		
	27		41		40	VW3A8306R10	25		
	36		42	GV4L80N	37		28		
	45		43		38	VW3A8306R30	25		
ATS480C66Y	18	DF431700	40		41		28		
	27		41	<b>L</b>	41	VW3A8306RC	25		
	36		42	LA9F702	27		28		
	45		43		33	VW3A8306TF03	25		
ATS480C79Y	18	DF4331000	40	LA9F703	27		28		
	27		41		33	VW3A8306TF10	25		
	36		42	LA9F704	27		28		
	45		43		33	VW3CANCARR03	30		
ATS480D17Y	18	DF433800	40	LA9LB920	42	VW3CANCARR1	30		
	27		41	LU9AD7	31	VW3CANTAP2	31		
	36		42	LU9GC3	25	VW3G48106	27		
	45		43		28		33		
ATS480D22Y	18	DF4441600	40	<b>T</b>		VW3G48107	27		
	27		41	TCSCAR013M120	30		33		
	36		42	TCSCAR01NM120	31	VW3G48108	27		
	45		43	TCSEGWB131W	23		33		
ATS480D32Y	18	DF4442200	40	TCSMCNAM3M002P	34	VW3G48109	27		
	27		41	TCSXCNAMUM3P	25		33		
	36		42	TSXCANCA100	30	VX4G4801	21		
	45		43	TSXCANCA300	30	VY1G480C01	21		
ATS480D38Y	18	<b>G</b>		TSXCANCA50	30	VY1G480M01	21		
	27	GK1EK	40						
	36		41						
	45		42						
ATS480D47Y	18		43						
	27								
	36								
	45								