Radio frequency identification XG range

Catalogue



Simply easy!™

 **Telemecanique**
Sensors

Selection guide *pages 4 and 5*

- **Presentation** *page 6*
- **Description** *pages 7 to 13*
- **Functions** *pages 14 and 15*
- **Characteristics**
 - Electronic tags *pages 16 and 17*
 - Readers *page 18*
 - Handheld terminal *page 18*
 - Connection boxes *page 19*
- **References**
 - RFID readers and electronic tags *page 20*
 - Connection boxes *page 21*
 - Field expanders *page 21*
 - Handheld terminal *page 21*
 - Connection accessories *pages 22 and 23*
- **Dimensions** *pages 24 and 25*
- **Connections** *pages 26 and 27*
- **Curves** *page 28*
- **Installation precautions** *page 29*

- **Product reference index** *page 30*

Freedom of choice

Select from the XG range, offer of industrial tags or from the ISO standard tags (non locked) available on the market.

> Worldwide compatibility

With 13.56 MHz standards (ISO 18000-3, ISO 15693, ISO 14443).

100%
compatible

for simplifying selection



> Automatic integration in your architecture

The **XG** RFID system simplifies access to the tag data.

No specific programming required, automatic adaptation to the protocol and speed of the network used (EtherNet/IP, Modbus TCP/IP, Modbus RTU, Uni-Telway, PROFIBUS-DP).

100%
compatible

for inclusion in architectures

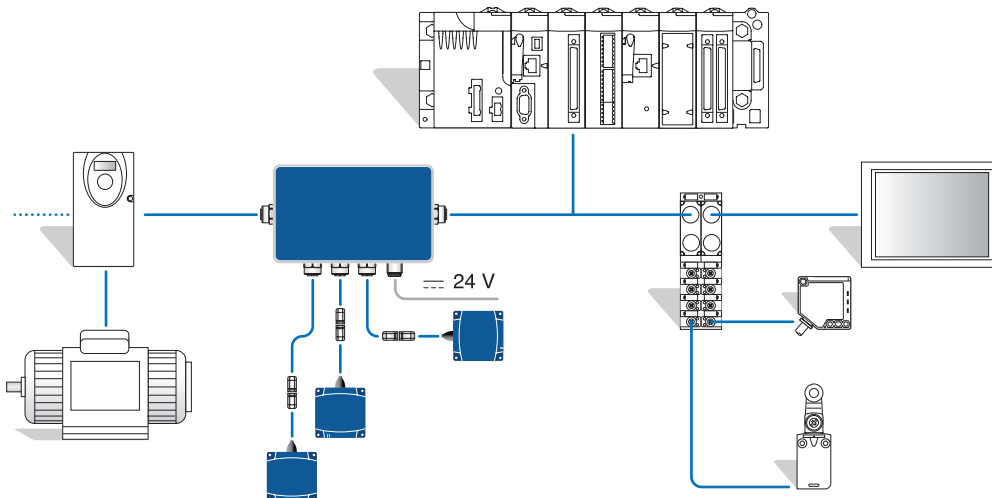

Simplicity and speed

With XG range, forget complex connections and configurations, you have the RFID system that is really easy to install.

> Easy to install

The smart antenna self-adapts to the environment and is easily installed even in the most confined spaces due to its compactness (40 x 40 x 15 mm), fixing accessories and quick cabling.



> Quick to connect and set-up

- Connect the smart antenna to the PLC and it's fully operational! Everything is integrated in the product (antenna, RFID controller, protocol).

- Simple presentation of the configuration badge sets the network address of the smart antenna.

+30%

savings in installation and setting-up time

- Use the hand held terminal (XGST2422) for direct access to data in the tags.



Tested and approved

Perfectly suited to your constraints and requirements, XG range is an offer that has been comprehensively tested both in the laboratory and in the field to ensure its reliability. Reduced consumption (< 60 mA per smart antenna) and materials used for the XG range make our products environmentally friendly.

100 % RoHs

Telemecanique Sensors commits itself to reducing the environmental impact of its products

Selection guide

	Material handling				Access control			Traceability		Flexible assembly	
Reading system	Trolley	Narrow conveyor or overhead line	Medium width conveyor	Wide conveyor	Operator	Service	Vehicle	Container	Tools	Simple	Tools
1 XGCS4901201											
2 XGCS8901201 and XGCS850C201											
3 XGCS4901201 + XGFEC540											
4 XGCS4901201 + XGFEC2525											
5 XGST2422											
RFID tags											
6 XGHB123345											
7 XGHB211345											
8 XGHB221346											
9 XGHB320345											
10 XGHB520246											
11 XGHB90E340											
12 XGHB444345											
13 XGHB320246											
14 XGHB440245											
15 XGHB440845											
16 XGHB441645											
17 XGHB443245											



- 1 XGCS4901201
- 2 XGCS8901201 and XGCS850C201
- 3 XGCS4901201 + XGFEC540
- 4 XGCS4901201 + XGFEC2525

Overall size of dialogue zone

Length x width (mm)	Distance (mm)											
	18	18	40	48	70	70	33	45	45	25	25	25
39 x 35	18	18	40	48	70	70	33	45	45	25	25	25
79 x 75	20	20	55	65	100	100	48	65	65	39	39	39
390 x 45	-	-	-	42	70	90	-	45	45	-	-	-
240 x 240	-	-	42	80	150	150	-	40	40	-	-	-
Memory capacity (bytes)	304	256	256	112	112	256	3408	2000	2000	8192	16384	32768



Radio frequency identification 13.56 MHz XG range



Compact smart antenna



Electronic tags



RFID handheld terminal



Network connecting box

Presentation

RFID (Radio Frequency IDentification) refers to radio frequency identification systems. These frequencies range between 50 kHz and 2.5 GHz. The most widely used is 13.56 MHz.

The XG RFID system makes it possible to perform traceability, object identification (tracking) and access control functions.

The information is stored in a memory that can be accessed using a simple radio frequency link. This memory is in the form of an electronic tag, which contains an antenna and an integrated circuit.

The tag contains the information associated with the object to which it is fixed. When a tag enters the field generated by the reader/smart antenna, it detects the signal and exchanges the data (read or write) between its memory and the reader/smart antenna.

The applications are numerous:

- Logistics: Goods Out, Goods In, transit, etc.
- Tracking and sorting of baggage
- Traceability in the food processing industry
- Flexible assembly lines in the automotive sector
- Automatic toll booths
- Access control, etc.

The RFID system is also suitable for use in difficult environments (humidity, temperature, mechanical shock, vibration, dust, etc.).

XG RFID system

The XG identification system is open to the majority of ISO 18000-3, ISO 15693 and ISO 14443 electronic tags.

The XG system integrates Modbus RTU, Uni-Telway, Modbus TCP/IP, PROFIBUS-DP and EtherNet/IP protocols.

The XG RFID offer comprises:

- 4 models of 13.56 MHz RFID reader (read/write)
- 12 models of 13.56 MHz electronic tag
- 1 RFID handheld terminal
- 3 models of network connection box
- 2 models of field expander (accessories enabling modification of the shape of the dialogue zone between the tag and compact smart antenna)
- Connection and mounting accessories

Setup

XG RFID readers are simple to set up:

- Integrated RFID and network functions
- No programming
- Automatic detection of the RFID electronic tags (read or write)
- Automatic setting of the communication parameters (speed, format, parity, protocol, etc.)
- Network address configuration (1 to 15) using the RFID card provided with the smart antenna or via PC software for the Ethernet smart antenna
- Read/write compatibility with the majority of 13.56 MHz tags on the market
- Low sensitivity to metal environments

Installation

XG readers are compact and robust. They can easily be integrated into flexible manufacturing production lines:

- quick connection using M12 connector
- clip-on mounting

An extensive range of connecting cables and adaptor boxes enables XG readers to be easily connected to communication networks.

Radio frequency identification

13.56 MHz

XG range



RFID reader: compact smart antenna, flat form 40



RFID readers: compact smart antennas, flat form 80



RFID reader: wand antenna with flexible head

Description

13.56 MHz RFID readers

XGCS readers enable reading and writing of 13.56 MHz RFID tags that are compatible with standards ISO 15693 and ISO 14443 A and B.

Four models of XG reader are available:

- Compact smart antenna, flat form 40, **XGCS4901201**:
 - Dimensions (mm): 40 x 40 x 15
 - Nominal sensing distance: 10 to 70 mm depending on the associated tag
- Compact smart antenna, flat form 80, **XGCS8901201**:
 - Dimensions (mm): 80 x 80 x 26
 - Nominal sensing distance: 20 to 100 mm depending on the associated tag
- Compact smart antenna, flat form 80, **XGCS850C201**:
 - Dimensions (mm): 80 x 93 x 40
 - Nominal sensing distance: 20 to 100 mm depending on the associated tag
- **XGW4F111** wand antenna with flexible head for location of tags located in places that are difficult to access, with the XGST2020 handheld terminal
 - Dimensions (mm): 290 x 40 x 25

Functions integrated in RFID readers:

XG RFID readers integrate functions which simplify communication between tags, readers and controllers (automation platform, PC, etc.).

These embedded functions are activated by standard requests to read/write words, sent by the automation platform:

- **Firmware version:** Polling of the reader to discover its version.
- **Reset:** The RFID reader is reinitialized and assumes its factory default configuration (network address at 1, transmission speed at 19,200 bauds, parameters deleted).
- **Init:** The reader is reinitialized and operates as it would after being switched back on (address unchanged, transmission speed unchanged, parameters deleted).
- **Sleep mode:** Transmission of the reader's electromagnetic field is only activated upon receipt of a read or write instruction. This mode reduces the reader's power consumption and prevents interference when the readers are close to one another.
- **Auto Read/Write:** This mode enables the reader to execute up to 10 read or write instructions in a tag automatically as soon as it enters the dialogue zone (up to 87 write words and up to 109 read words).

Communication

RS485 serial port

■ **XGCS4901201** and **XGCS8901201** readers, equipped with an RS485 serial port, support Modbus RTU and Unitelway protocols, enabling up to 123 words to be exchanged per read or write request.

■ The communication parameters and protocol are detected automatically. The smart antennas require no configuration.

■ Up to 15 smart antennas can be connected to the same network. All connections are made via M12 connectors, using a complete range of cables, T-connectors and network adaptors.

Ethernet

■ The **XGCS850C201** Ethernet smart antenna is equipped with two M12 connectors, enabling up to 32 smart antennas to be daisy-chained. Looping of the ring network is supported.

■ The protocols supported are Modbus/TCP and EtherNet/IP. They permit up to 123 words to be exchanged per transaction.

■ The supported I/O scanning and assembly services enable permanent access to the smart antenna status and synchronization as the tags pass in front of the smart antenna.

■ The network address parameters are easily set, using:

- dedicated software (IP Recovery Tool), to be downloaded from the website www.tesensors.com/global/en/documents/1471/1555898/,
- or handheld terminal **XGST2020** (from version V2.37)

Radio frequency identification 13.56 MHz XG range



Electronic tags



Handheld terminal



Field expanders

Description (continued)

RFID electronic tags

■ XGHB electronic tags with EEPROM or FeRAM type memory (1) offer the following advantages:

- Fast access to data
- Wide range of memory capacities
- Secure access to contents
- Batteryless operation
- Positioning flexibility
- Protection suited to the environmental conditions

The nominal transmission distance is 18 to 100 mm, depending on the tag model and associated reader.

RFID handheld terminal

The XGST2020 RFID terminal, with firmware and wand antenna, is a powerful tool for easy and efficient operations on RFID tags.

The removable wand antenna communicates with a wide range of ISO 14443 and ISO 15693 electronic tags. It is also has a wide dialogue range of up to 70 mm.

The integrated battery provides the terminal with excellent autonomy (at least one full day of intensive use).

Field expanders

Field expanders are accessories designed to operate with XG smart antennas.

They enable the shape of the dialogue field of the XGCS4901201 smart antenna to be adapted to conveying/handling applications.

The concept is a connection-free induction link between the smart antenna and the field expander. Two standard models are available:

■ The XGFEC540 conveyor model detects ISO 15693 tags on a narrow strip covering the width of the conveyor (mounted between two rollers of the conveyor).

- Dimensions (mm): 400 x 23 x 50
- Nominal sensing distance: 30 to 90 mm depending on the associated tag

■ The XGFEC2525 universal model increases the area and distance for detection of ISO 15693 tags, which also enables higher passing speeds of the tags.

- Dimensions: 250 x 250 x 10
- Nominal sensing distance: 26 to 150 mm depending on the associated tag

■ Read/write compatibility with the majority of 13.56 MHz ISO 15693 tags on the market

(Caution: these accessories are not compatible with ISO 14443 tags).

(1) **EEPROM** (Electrically-Erasable Programmable Read-Only Memory).
FeRAM (Ferroelectric Read-Only Memory): non-volatile RAM.

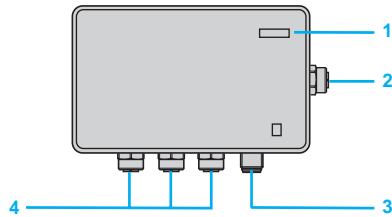

XGSZ33ETH Ethernet box

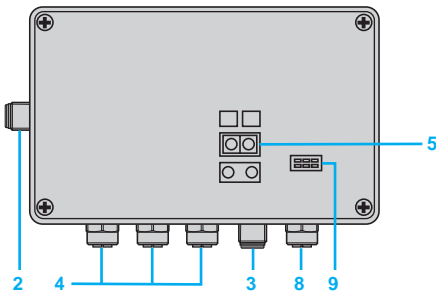

XGSZ33EIP EtherNet/IP box

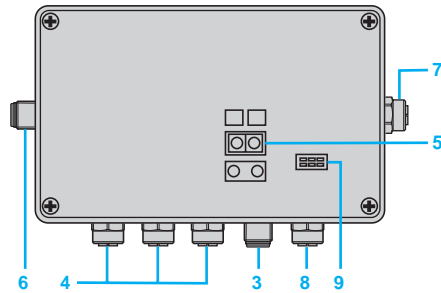

XGSZ33PDP PROFIBUS-DP box

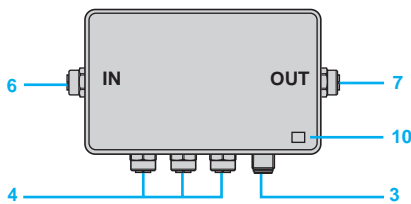

TCSAMT31FP tap-off box

- 1 Power on and Ethernet indicator LEDs
- 2 One M12 type Ethernet socket, D-coded
- 3 One M12 type power supply socket, male 4-pin
- 4 Three M12 type female sockets, A-coded, for connecting XGCS smart antennas
- 5 Network address configuration
- 6 One male M12 type network input socket
- 7 One female M12 type network output socket
- 8 One female M12 type configuration port
- 9 Network and connection box status LEDs
- 10 One green LED: power on

Description (continued)

XG connection boxes

Four types of quick connection box are available:

- XGSZ33ETH Ethernet box for Ethernet Modbus TCP/IP network
- XGSZ33EIP EtherNet/IP box for EtherNet/IP network
- XGSZ33PDP PROFIBUS-DP box for PROFIBUS-DP network
- TCSAMT31FP tap-off box for Modbus and Uni-Telway communication bus

XGSZ33ETH Modbus TCP/IP box

The XGSZ33ETH box enables connection of XGCS smart antennas to the Ethernet network (Modbus TCP/IP protocol).

It enables an automation platform or PC to access the XGCS smart antenna functions:

- Reading/writing tags
- Control and command
- Monitoring
- Diagnostics

The XGSZ33ETH box is fitted with M12 connectors. It is used to connect the power supply, the Ethernet network and 1 to 3 XGCS smart antennas (up to 8 smart antennas, by daisy-chaining).

XGSZ33EIP EtherNet/IP box

The XGSZ33EIP box enables connection of XGCS smart antennas to the EtherNet/IP network.

It enables an automation platform or PC to access the XGCS smart antenna functions:

- Reading/writing tags
- Control and command
- Monitoring
- Diagnostics

The XGSZ33EIP box is fitted with M12 connectors. It is used to connect the power supply, the EtherNet/IP network and 1 to 3 XGCS smart antennas (up to 15 smart antennas, by daisy-chaining).

XGSZ33PDP PROFIBUS-DP box

The XGSZ33PDP box enables connection of XGCS smart antennas to the PROFIBUS-DP network.

It enables an automation platform or PC to access the XGCS smart antenna functions:

- Reading/writing tags
- Control and command
- Monitoring
- Diagnostics

The XGSZ33PDP box is fitted with M12 connectors. It is used to connect the power supply, the PROFIBUS-DP network and 1 to 3 XGCS smart antennas (up to 15 smart antennas, by daisy-chaining).

TCSAMT31FP tap-off box

The TCSAMT31FP tap-off box enables connection of XGCS smart antennas to Modbus and Uni-Telway communication buses.

The TCSAMT31FP box is fitted with M12 connectors.

It is used to connect the power supply, the communication bus (Modbus) and 1 to 3 XGCS smart antennas (up to 15 smart antennas, by daisy-chaining).

It consists of a dust and damp-proof metal enclosure.

Description (continued)

Mounting example for a Modbus network

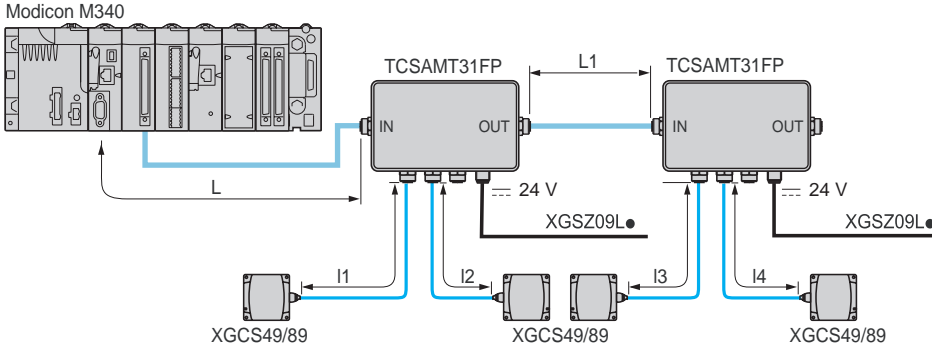

Maximum length of bus
The maximum length of the bus ($L + L1 + I4$) depends on the speed of the network:
- 9600 bauds: 1000 m
- 19,200 bauds: 500 m

Maximum length of tap-offs:
I1, I2 and I3: 10 m

Examples of connection to a Schneider Electric automation platform

Direct connection

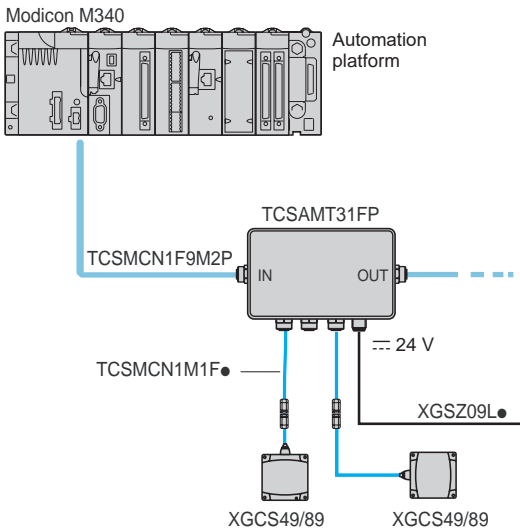

Connection via a TSXSACA62

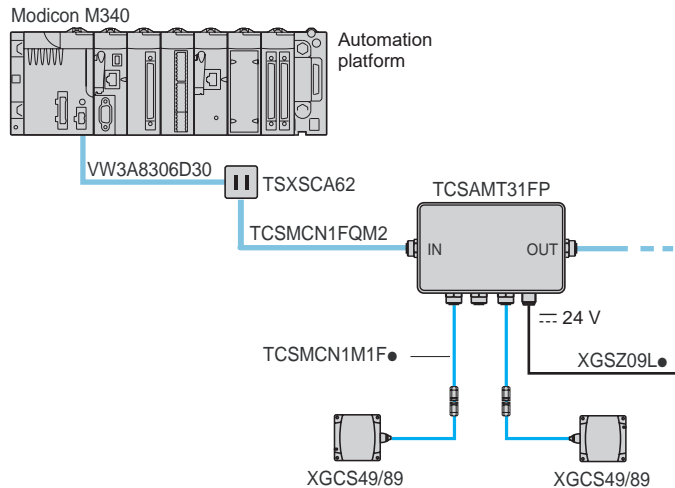

Daisy-chain connection

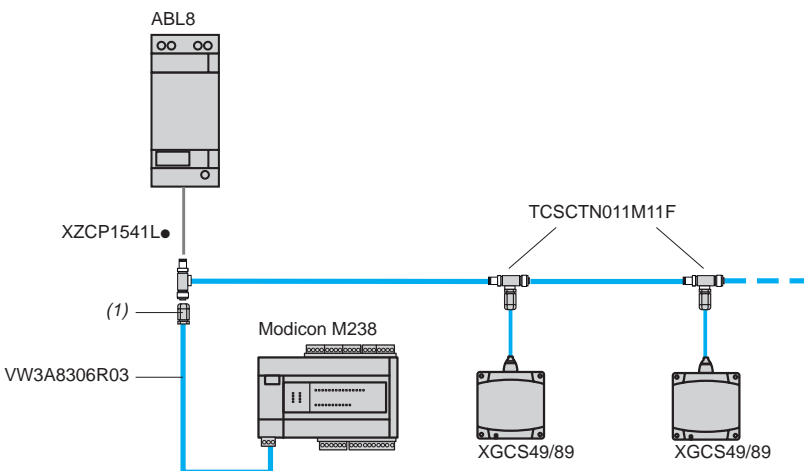

(1) XZCC12MDB50R male M12 connector, to be ordered separately (see page 23).

RFID readers can be connected directly to the Modbus port of an automation platform. Up to 15 RFID readers can be linked to the RS 485 port using "T" connectors (in cases where the length of the network exceeds 100 m, fit a line terminator, reference TM7ACTLA).

This cabling system is specific to the XG range (powered network).

No other Modbus slave equipment must be connected to it.

Description (continued)

Mounting examples for an Ethernet network

Star topology

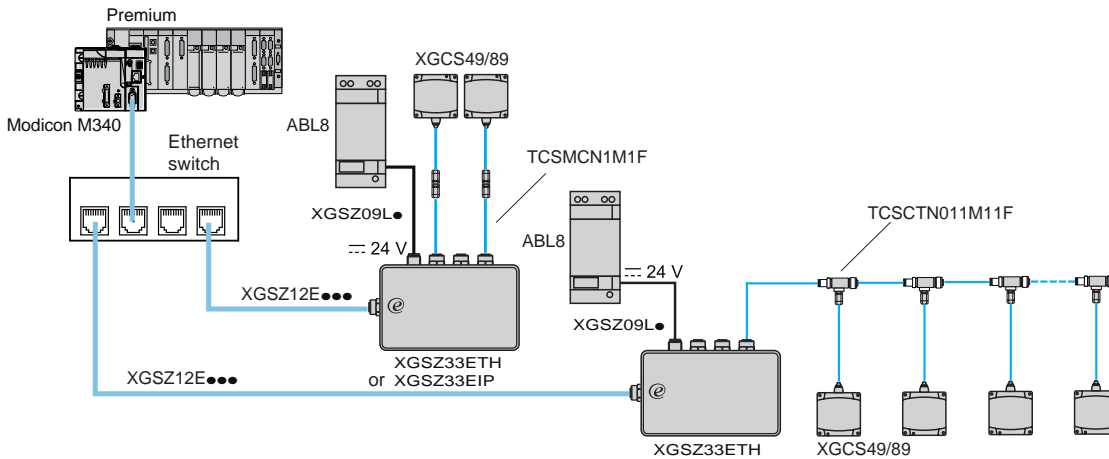
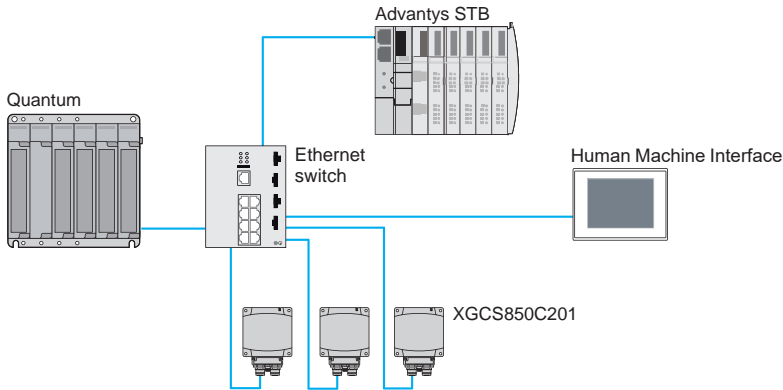

The number of smart antennas connected to each box can be increased by using M12 “T” connectors (ref. TCSCTN011M11F).

Note concerning use of the XGSZ33ETH box on Modbus/TCP: to maintain high-performance operation it is recommended that a maximum of 8 RFID smart antennas are connected (the Ethernet box has 8 communication ports that can be open simultaneously on TCP/IP). In cases where the I/O scanning function is used (which requires an additional communication port), do not connect more than 7 smart antennas. The total length of the smart antenna-side network for XGCS49/89 smart antennas is limited to 160 m.

Daisy chain topology

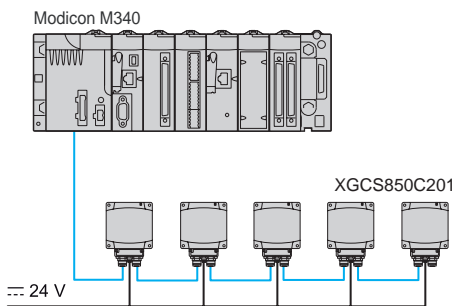

Ring topology

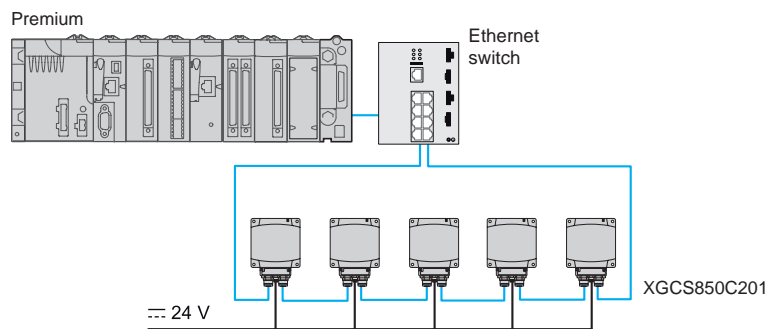

Radio frequency identification 13.56 MHz XG range

Example of mixed IP 20 and IP 67 connection on Ethernet network

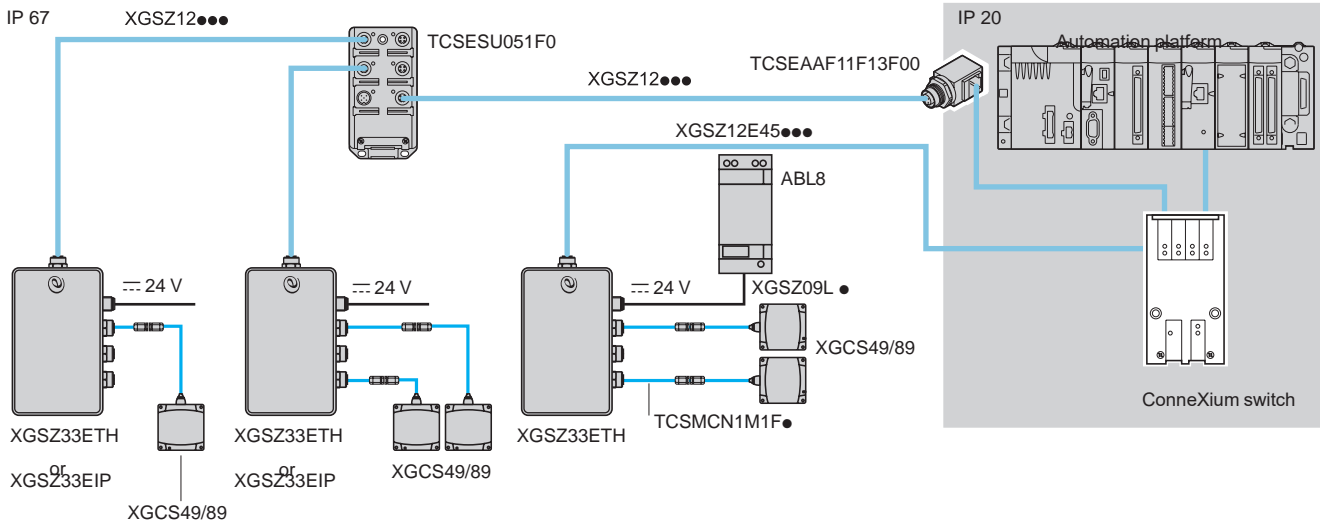

Examples of connection to a Magelis terminal

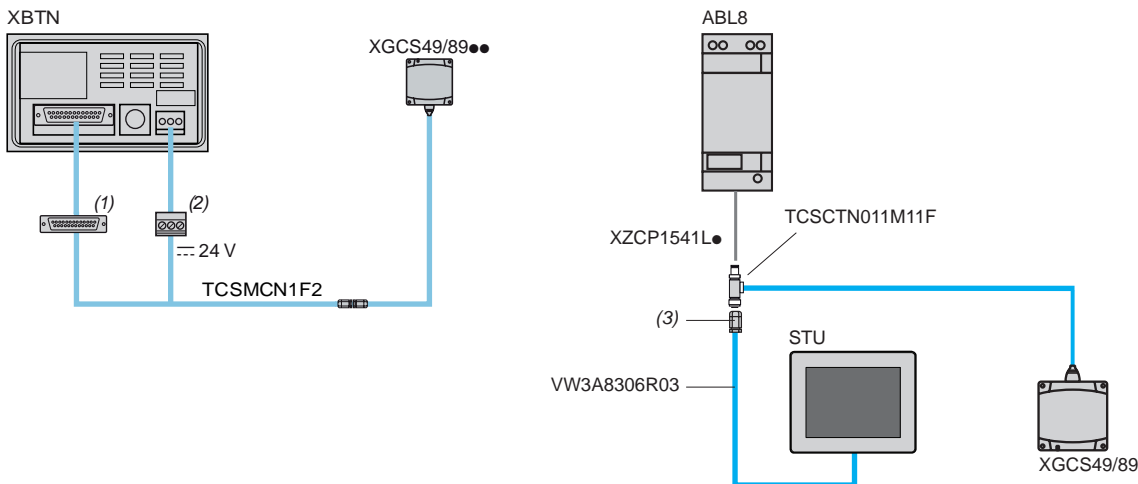

(1) 25-pin male SUB-D connector.

(2) Magelis terminal power supply connector (supplied with the Magelis terminal).

(3) **XZCC12MDB50R** M12 male connector, to be ordered separately (see page 23).

RFID smart antennas can be connected directly to the Modbus port of an automation platform. Up to 15 RFID smart antennas can be linked to the RS 485 port using "T" connectors (in cases where the length of the network exceeds 100 m, fit a line terminator, reference TM7ACTLA). This cabling system is specific to the XG range (powered network). No other Modbus slave equipment must be connected to it.

Example of architecture in a PROFIBUS-DP network

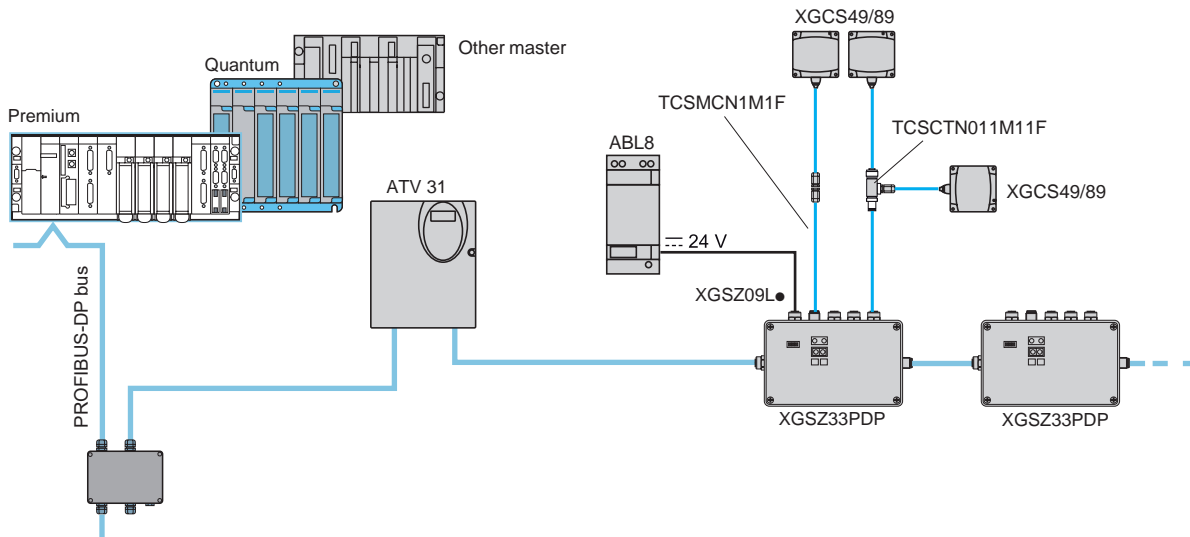

Example of connection to a PC

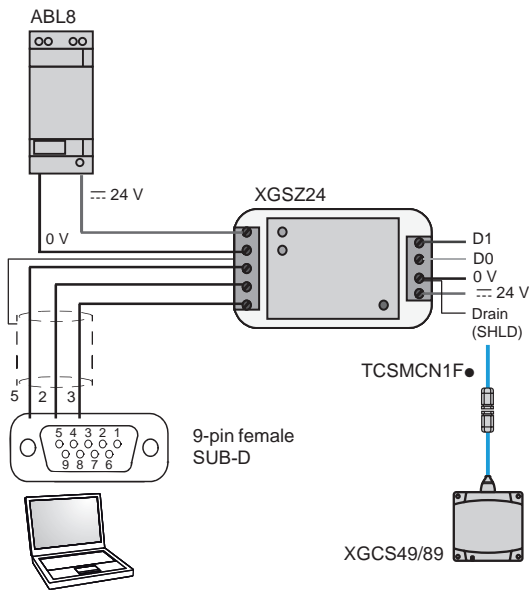

RFID smart antennas can be connected directly to the Modbus port of an automation platform. Up to 15 RFID smart antennas can be linked to the RS 485 port using “T” connectors (in cases where the length of the network exceeds 100 m, fit a line terminator, reference TM7ACTLA). This cabling system is specific to the XG range (powered network). No other Modbus slave equipment must be connected to it.

Radio frequency identification

13.56 MHz

XG range

Handheld terminal



Handheld terminal



Main screen



Tag tools

XGST2020 handheld terminal

Functions

Three types of function are embedded in the terminal:

- Direct operations on RFID tags
- Mapping (screens predefined by the operator)
- Configuration

Direct processing of RFID tags

■ **Read/Write words.** Groups containing up to 15 words can be read/written from a given start address. Dates can be displayed in different formats: Decimal/Signed decimal/Binary/Decimal IP/Hexadecimal/ASCII.

■ **Copy tag** from one tag to another. The whole tag memory or part of it can be copied.

■ **Tag initialization.** The whole tag memory or a defined part of it can be written using a value chosen by the operator.

■ **Tag presence.** Cyclic test for presence of the tag in front of the RFID reader linked to the terminal. An indicator light and a bargraph provide information regarding the test results.

■ **Tag identification.** The RFID protocol, unique identifier and user memory size of a tag, which are in front of the reader, are detected by a scanner activated by the handheld terminal and displayed on screen.

Mapping

A mapping is a list of variables, stored permanently in the terminal memory for quick and simple access by the operators.

Each mapping variable is associated with a name and displayed in the selected format in the selection list, in read only or read/write mode. Creation, modification and backup tools are embedded in the handheld terminal software.

Up to 256 mappings can be stored in the memory (each being identifiable by a number and a name).

Each mapping can contain up to 256 variables. Each variable is defined by its position within the tag memory, its size and its type (word or byte) and its display format on screen.

The formats supported by the handheld terminal are:

- Decimal (1 word): 0 to 65535
- Decimal (1 byte): 0 to 255
- Signed decimal (1 byte): -128 to +127
- Decimal IP (2 words): 0.0.0.0 to 255.255.255.255
- Hexadecimal (4 bytes): 0000 to FFFF
- Boolean bit (one bit):
- Binary (1 byte): 00000000 to 11111111
- List (1 byte): 0 to 15. A string, associated with each byte value, is displayed on screen in place of the byte value
 - ASCII string: 1 to 21 characters
 - Hexadecimal string: 2 to 30 hexadecimal characters (1 to 15 bytes)
 - Date (8 bytes): YYYY/MM/DD
 - Time (2 bytes): HH:MM

The data displayed on a mapping can be stored in the terminal memory or written to an RFID tag.

A backup of each mapping or all mappings can be stored on a USB memory stick inserted in the USB socket of the handheld terminal.

Radio frequency identification

13.56 MHz

XG range

Handheld terminal



Mapping management

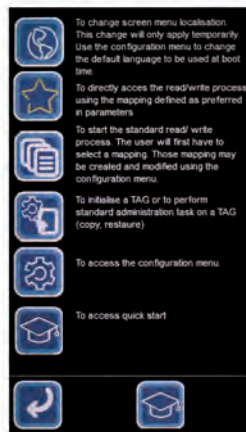

Online help

XGST2020 handheld terminal (continued)

Functions (continued)

Configuration

■ Updating the terminal

This function is password-protected and provides access to the following elements:

- Updating the RFID reader linked to the handheld terminal
- Changing the boot screen picture by uploading a file from a USB memory stick
- Restoring the handheld terminal to factory settings
- Changing the password

■ Terminal parameters

This function is used to modify the following elements:

- Screen localization
- Shutdown delay
- Preferred mapping number
- Ethernet port gateway and IP addresses
- Backlighting level

■ Mapping management

This function is used to access the following elements:

- Backup and restoration of all user mappings from and to the USB memory stick
- Exporting and importing a user mapping from and to the USB memory stick
- Creation, modification, copying and deletion of mappings. Each mapping is password-protected.

Online help

Contextual online help is permanently accessible for users.

Furthermore, a tutorial on mapping creation can be accessed via the main screen.

Battery management

The handheld terminal is powered by a high-capacity lithium battery.

- The battery charge status is displayed on the menu screen.
- A blue LED flashes when the battery needs recharging.
- An orange LED flashes while the battery is charging.

Accessories

Handheld terminal accessories

The handheld terminal is supplied in an XGST2422 plastic case, with the following accessories:

- A USB charger with international plugs
- An XGST2BA high-capacity lithium battery
- An XGSZK1 2 GB USB flash memory stick for transferring data between handheld terminals or to and from the PC. This USB memory stick also contains all the technical documents on the XG RFID range: catalogues, training and examples.
- A stylus for the touch screen
- A wrist strap for safe handling of the terminal
- An Allen key

The RFID reader connected to the terminal should be ordered separately, see page 20.

RFID readers associated with the handheld terminal

Two RFID reader versions are available:

- XGCS4901201 compact smart antenna for mounting on the back of the handheld terminal
- XGW4F111 wand antenna with flexible head for remote operations on tags located in confined places (under pallets, for example)



XGST2422







XGW4F111

Radio frequency identification







13.56 MHz

XG range

Characteristics of electronic tags

Tag type		XGHB123345	XGHB211345	XGHB221346	XGHB320345	
						
Ambient air temperature	For operation	°C	-25...+70	-25...+70	-25...+70	-25...+85 (4)
	For storage	°C	-40...+85	-40...+85	-40...+85	-40...+90
Degree of protection			IP 68	IP 68	IP 68	IP 68
Standard supported			ISO 15693	ISO 15693	ISO 15693	ISO 15693
Vibration resistance	Conforming to EN 60068.2.6		2 mm from 5 to 29.5 Hz/7 gn from 29.5 to 150 Hz			
Shock resistance	Conforming to EN 60068.2.27		30 gn/11 ms			
	Conforming to EN 50102		Degree IK02			
Dimensions		mm	Ø 12 x 8	M18 x 1 x 12	26 x 26 x 13	Ø 30 x 3
Housing material			PBT	PBT	PBT	PPA
Fixing method			Glued	Screw	Screw or clip	Screw
Memory capacity		bytes	304	256	256	112
Type of memory			EEPROM			
Type of operation			Read/Write			
Nominal sensing distance (Read/Write)	With XGCS4901201	mm	18	18	40	48
	With XGCS8901201 or XGCS850C201	mm	20	20	55	65
	With XGCS4901201 smart antenna + XGFEC540	mm	–	–	–	42
	With XGCS4901201 smart antenna + XGFEC2525	mm	–	–	42	80
Number of read cycles			Unlimited			
Number of write cycles	Guaranteed minimum (per data bit, throughout the temperature range)		100,000			
	At 30°C		2.5 million typical value			
Read time		ms	12 + 0.825 x n (1)	12 + 0.825 x n (1)	12 + 0.825 x n (1)	12 + 0.825 x n (1)
Write time		ms	20 + 11.8 x n (1)	19 + 4.1 x n (1)	20 + 11.8 x n (1)	12 + 5.6 x n (1)
Max. speed XGCS49●●	Read a serial number	ms	1.8	1.8	2.8	3.1
	Read a word (2)	ms	0.6	0.6	0.8	1.4
	Read or write 10 words (2)	ms	0.2	0.2	0.3	0.7
Max. speed XGCS89●● and XGCS850C201	Read a serial number	ms	3	3.2	4.2	5.8
	Read a word (2)	ms	0.9	1.1	2.6	2.7
	Read or write 10 words (2)	ms	0.4	0.6	0.5	0.9
Data retention time			10 years			
Mounting on metal support			No	No	Yes (3)	No

(1) n = number of 16-bit words.
 (2) With use of the Auto read/write function.
 (3) Installation precautions: see page 29.
 (4) + 140°C for 10 minutes maximum, except for data exchange.

	XGHB520246	XGHB90E340	XGHB444345	XGHB320246	XGHB440245	XGHB440845, XGHB441645 and XGHB443245
						
	-25...+85 (4)	-25...+50	-25...+70	-25...+70	-25...+70	-25...+70
	-40...+90	-40...+55	-40...+85	-40...+85	-40...+85	-40...+85
	IP 68	IP 65	IP 68	IP 68	IP 68	IP 68
	ISO 15693	ISO 15693	ISO 14443	ISO 15693	ISO 15693	ISO 14443
	2 mm from 5 to 29.5 Hz/7 gn from 29.5 to 150 Hz			30 gn/11 ms		
	30 gn/11 ms			30 gn/11 ms		
	Degree IK02			Degree IK02		
	Ø 50 x 3	54 x 85.5 x 1	40 x 40 x 15	Ø 30 x 3	40 x 40 x 15	40 x 40 x 15
	PPA	PVC	PBT	PPA	PBT	PBT
	Screw	–	Screw or clip	Screw	Screw or clip	Screw or clip
	112	256	3408	2000	2000	8192 (XGHB440845) 16,384 (XGHB441645) 32,768 (XGHB443245)
	EEPROM			FeRAM		
	Read/Write			Read/Write		
	70	70	33	45	45	25
	100	100	48	65	65	39
	70	90	–	45	45	–
	150	150	–	40	40	–
	Unlimited			10 ¹⁰		
	100,000			10 ¹⁰		
	2.5 million typical value			–		
	12 + 0.825 x n (1)	12 + 0.825 x n (1)	9.25 + 0.375 x n (1)	7 + 2 x n (1)	7 + 2 x n (1)	6 + 0.25 x n (1)
	12 + 5.6 x n (1)	20 + 11.8 x n (1)	13 + 0.8 x n (1)	7 + 2.4 x n (1)	7 + 2.4 x n (1)	6 + 0.25 x n (1)
	5.3	5.3	3.1	2.1	2.1	2.3
	1.6	1.6	1.4	1.5	1.5	1.8
	0.6	0.6	1.2	0.6	0.6	1.7
	7.1	7.1	4.8	3.5	3.5	3.8
	4.0	4.0	2.7	2.5	2.5	3.0
	0.8	0.8	1.8	1	1	2.6
	10 years					
	No	No	Yes (3)	No	Yes	Yes

Radio frequency identification 13.56 MHz XG range

Characteristics of XG readers						
RFID reader type		XGCS850C201	XGCS8901201	XGCS4901201	XGW4F111	
Certifications		UL, FCC part 15c C€				
Conforming to standards		EN 301489-1, EN 301489-3, ETS 300330-1 and ETS 300330-2				
Ambient air temperature	For operation	°C	- 25...+ 70			
	For storage	°C	- 40...+ 85			
Degree of protection	Conforming to IEC 60529		IP 65			
Vibration resistance	Conforming to EN 60068.2.6		2 mm from 5 to 29.5 Hz/7 gn from 29.5 to 150 Hz			
Shock resistance	Conforming to EN 60068.2.27		30 gn/11 ms			
	Conforming to EN 50102		Degree IK02			
Resistance to interference	Conforming to IEC 61000		Resistance to electrostatic discharge, radiated electromagnetic fields, fast transients, electrical surges, conducted and induced interference and network frequency magnetic fields.			
Dimensions, W x H x D		mm	Flat form: 80 x 93 x 40	Flat form: 80 x 80 x 26	Flat form: 40 x 40 x 15	290 x 40 x 25
RFID frequency		MHz	13.56			
Nominal sensing distance		mm	20 to 100 depending on associated tags	10 to 70 depending on associated tags		
Type of associated tag			ISO 15693 and ISO 14443 standardized tags. Automatic detection of the tag type			
Examples of RFID compatible chips			Fujitsu (MB89R118), INSIDE (micropass) NXP (I-Code SL2, SL1, Ultralight, Std 1K/4K, Desfire), STM (CR1X4K) Texas (Tag-it HFI), µEM4135			
Nominal supply voltage		V	24 --- PELV (Protective Extra Low Voltage)			
Supply voltage limits (including ripple)		V	19.2...29 ---			
Consumption		mA	< 150	< 60		
Communication ports	Physical interface		10BASE-T/ 100BASE-TX	RS 485		
	Protocol		Modbus/TCP and EtherNet/IP	Modbus RTU and Uni-Telway	Modbus RTU	
	Data rate		10/100 Mbps	9600...115,000 bauds (automatic detection)		
	Medium (see cable references on page 22)		Ethernet cable with M12 connector, D-coded	Two shielded twisted pair cable with M12 connector, A-coded		
Display	For network communication		4 two-tone LEDs (Ethernet)	1 two-tone LED (Modbus/Uni-Telway)		
	For RFID communication		2 two-tone LEDs	1 two-tone LED (Presence of tag/Reader/tag dialogue)		
Connections			2 female M12 connectors, D-coded for Ethernet 1 male 4-pin M8 connector for power supply	A single male 5-pin shielded M12 connector, A-coded, for connection to the communication network and power supply		
Tightening torque	Screw		< 3 Nm/2.21 lb-ft	< 3 Nm/2.21 lb-ft	< 1 Nm/0.74 lb-ft	–

Characteristics of the XGST2020 handheld terminal					
Certifications			C€		
Conforming to standards			IEC 61000-6-2, IEC 61000-6-4		
Ambient air temperature	For operation	°C	0 ... + 45		
	For storage	°C	- 20... + 45		
Material	Casing		ABS		
Power supply	Internal		3.7 V/4000 mAh lithium battery. Full charge duration: 8 hours		
	Charging connector		Mini USB		
Autonomy	Typical		> 8 hours (reading one tag per minute - screen brightness = standard)		
	Minimum		> 3 hours (continuous reading)		
Charging time	Maximum		< 8 hours (to fully charge a completely flat battery)		
Degree of protection	Conforming to IEC 60529		IP 40		
	Conforming to IEC 62262		IK02 (touch screen)		
	Drop test		Free fall onto a concrete floor: 1 meter		
RFID reader serial link connection	Connector		M12 female socket		
	Type		RS485		
	Protocol		Modbus RTU master		
	Speed	Bauds	115,000		
External port			USB for memory stick (2 GB maximum)		
Operating system			Proprietary operating system		
Display			OLED resistive touch screen: 480 x 272 pixels, 16 M colours		
Signalling			Two-tone (blue/orange) power supply and status LED		

Radio frequency identification 13.56 MHz XG range

Characteristics of connection boxes				
Connection box type		XGSZ33ETH Ethernet Modbus/TCP box	XGSZ33EIP EtherNet/IP box	XGSZ33PDP PROFIBUS-DP box
Certifications		UL	–	PROFIBUS
Conforming to standards		CE		
Ambient air temperature	For operation	°C	0...+ 70	0...+ 55
	For storage	°C	- 40...+ 85	- 25...+ 85
Relative humidity		RH	30...95% non-condensing	
Degree of protection			IP 65	
Supply voltage		V	24 --- PELV (limits 19.2 V...29 V). Male 4-pin M12 connector, A-coded	24 --- PELV (limits 21.6 V...26.4 V). Male 4-pin M12 connector, A-coded
Consumption (box only)		W	< 1	< 2.5
Smart antenna connection			Female 5-pin M12 connector, A-coded Total cable length < 160 meters	
Electromagnetic interference	Conforming to IEC 61000		Level 3	
	Conforming to EN 55022		Class B	
Protocol			Modbus TCP/IP	EtherNet/IP
LED display			<ul style="list-style-type: none"> - Ethernet network activity (RUN, green) - Collision detection (COL, red) - Diagnostics (STS, yellow) - Fault (Err, red) - Power on (green) 	<ul style="list-style-type: none"> - Ethernet network activity (RUN, green) - Ethernet network activity (OFF, red) - Communication bus (Error, flashing red) - Modbus (RUN, green) - Gateway configuration (green)
Transparent Ready Services	Class		A10	–
	Standard Web server		IP configuration address	–
	Standard communication services		Modbus messaging (read/write words: 1 to 123 words per request)	Read/write words (1 to 123 per request) via the periodic exchanges service.
Connection	Physical interface		10BASE-T/100BASE-TX	RS485
	Data rate		10/100 Mbps	9.6 to 12,000 kbauds - automatic detection of speed
	Medium		Ethernet cable with M12 connector, D-coded, reference XGSZ12E●● (see page 22)	PROFIBUS cable with M12 connector, B-coded
Connection box type		TCSAMT31FP tap-off box		
Certifications		UL		
Conforming to standards		CE		
Ambient air temperature	For operation	°C	- 25...+ 55	
	For storage	°C	- 40...+ 85	
Relative humidity		RH	30...95% non-condensing	
Degree of protection			IP 65	
Supply voltage		V	24 --- PELV (limits 19.2 V...29 V). Male 4-pin M12 connector, A-coded	
Smart antenna connection			Female 5-pin M12 connector, A-coded	
Electromagnetic interference	Conforming to IEC 61000		Level 3	
	Conforming to EN 55022		Class B	
LED display			Power supply (green)	

Radio frequency identification 13.56 MHz XG range



XGCS850C201



XGCS4901201



XGW4F111



XGHB44445



XGHB90E340



XGHB221346



XGHB320345



XGHB211345

13.56 MHz RFID readers

Description	Protocols	Dimensions mm	Reference	Weight kg
Ethernet compact smart antenna Form 80 2 x M12 connectors 1 x M8 connector	Modbus TCP and EtherNet/IP	80 x 93 x 40	XGCS850C201	0.360
Compact smart antenna Flat form 80 (1) Male M12 connector on flying lead	Modbus RTU and Uni-Telway	80 x 80 x 26	XGCS8901201	0.257
Compact smart antenna Flat form 40 (1) Male M12 connector on flying lead	Modbus RTU and Uni-Telway	40 x 40 x 15	XGCS4901201	0.057
Wand antenna with flexible head and 1-meter cable Male M12 connector on flying lead	Modbus RTU	290 x 40 x 25	XGW4F111	0.228

Electronic tags (2)

Tag type	Nominal sensing distance according to smart antenna (mm) XGCS49● XGCS89●	Dimensions (mm)	Sold in lots of	Unit reference	Weight kg
Tag with EEPROM type memory					
Cylindrical 304 bytes	10	–	5	XGHB123345	0.008
Cylindrical 256 bytes	18	20	5	XGHB211345	0.020
Flat form 26 256 bytes	40	55	1	XGHB221346	0.025
Disc 112 bytes	48	65	5	XGHB320345	0.005
Disc 112 bytes	70	100	10	XGHB520246	0.015
ISO RFID card (3) 256 bytes	70	100	10	XGHB90E340	0.005
Flat form 40 3408 bytes	33	48	1	XGHB444345	0.031
Tag with FeRAM type memory					
Disc 2000 bytes	45	65	5	XGHB320246	0.005
Flat form 40 2000 bytes	45	65	1	XGHB440245	0.031
Flat form 40 8192 bytes	25	39	1	XGHB440845	0.031
Flat form 40 16,384 bytes	25	39	1	XGHB441645	0.031
Flat form 40 32,768 bytes	25	39	1	XGHB443245	0.031

(1) Supplied with an XGSZCNF01 configuration badge. Installation guide to be downloaded from www.tesensors.com.

(2) Other versions (high temperature, adhesive, flexible tags, etc.): please contact our Customer Care Centre.

(3) Customized versions on request.



TCSAMT31FP



XGFEC2525



XGFEC540



XGST2422



XGST2BA

Connection boxes

Description	For use with	Voltage	Reference	Weight kg
Modbus/TCP Ethernet box	Compact smart antennas XGCS49● and XGCS89●	24 V $\overline{\text{---}}$	XGSZ33ETH	1.060
EtherNet/IP box (1)	Compact smart antennas XGCS49● and XGCS89●	24 V $\overline{\text{---}}$	XGSZ33EIP	1.060
PROFIBUS-DP box (1)	Compact smart antennas XGCS49● and XGCS89●	24 V $\overline{\text{---}}$	XGSZ33PDP	1.060
Tap-off box, 3-channel Modbus and Uni-Telway	Compact smart antennas XGCS49● and XGCS89●	24 V $\overline{\text{---}}$	TCSAMT31FP	1.060

Field expanders

Description	Nominal sensing distance	For use with	Reference	Weight kg
Conveying type field expander Dimensions (mm) 400 x 23 x 50 (2)	30 ... 90 mm depending on tag used (ISO 15693 only)	Smart antenna XGCS4901201 Tags XGHB90E340 XGHB320345 XGHB520246 XGHB320246 XGHB440245	XGFEC540	0.640
Universal type field expander Dimensions (mm) 250 x 250 x 10 (2)	26 ... 150 mm depending on tag used (ISO 15693 only)	Smart antenna XGCS4901201 Tags XGHB90E340 XGHB221346 XGHB320345 XGHB520246 XGHB320246 XGHB440245	XGFEC2525	0.565

XG handheld terminal

Description	Composition	Reference	Weight kg
RFID handheld terminal set in a plastic case	<ul style="list-style-type: none"> ■ 1 handheld terminal ■ 1 wrist strap ■ 1 lithium battery ■ 1 battery charger pack ■ 1 stylus ■ 1 USB memory stick 	XGST2422	1.000

Note: RFID reader to be ordered separately (see page 20).

Accessories

Description	Reference	Weight kg
Screen protector sheets Sold in lots of 5	XGST2FP	0.005

Spare parts

Description	Reference	Weight kg
Handheld terminal Terminal unit only (without battery, charger or RFID reader)	XGST2020	0.295
Lithium battery 3.7 V, 4000 mAh	XGST2BA	0.078
USB memory stick 2 GB	XGSZK1	0.008

(1) Configuration file and installation guide to be downloaded from www.tesensors.com.

(2) Field expanders with other dimensions: please contact our Customer Care Centre.

Radio frequency identification 13.56 MHz XG range



TCSMCN1FQM2



TCSMCN1F9M2P



TCCTN011M11F



TCSESU051F0



TCSEAAF11F13F00



ABL8MEM24003

Modbus network connection accessories

Description	For use with	Length m	Reference	Weight kg
Shielded cable: Modbus black IP 67 M12 connectors, male/female, A-coded	RS 485 connection between a compact smart antenna and a tap-off box or between 2 TCSAMT31FP tap-off boxes	1	TCSCMCN1M1F1	0.080
		2	TCSCMCN1M1F2	0.115
		5	TCSCMCN1M1F5	0.270
		10	TCSCMCN1M1F10	0.520
Shielded pre-wired connector: Modbus IP 67 female M12 connector/bare wires, A-coded	Connection between a TCSAMT31FP tap-off box and a Modbus/Uni-Telway (TSXSACA50) network	2	TCSCMCN1F2	0.115
		5	TCSCMCN1F5	0.270
		10	TCSCMCN1F10	0.520
Shielded cable: Modbus black M12/SUBD-15, A-coded	Connection between a TCSAMT31FP tap-off box and a Modbus/Uni-Telway (TSXSACA62) network	2	TCSCMCN1FQM2	0.270
Shielded cable: Modbus black M12/Mini-DIN, 8-pin, A-coded	Modbus connection between a TCSAMT31FP tap-off box and an automation platform (Premium, Twido, etc.)	2	TCSCMCN1F9M2P	0.350
Modbus SL serial link cable (RS 485 double shielded twisted pair main cables)	Modbus SL serial link	100	TSXCSA100	5.680
		200	TSXCSA200	10.920
		500	TSXCSA500	30.000
Network Tee, M12 1M/2F A-coded, 5-pin	RS485 network	–	TCCTN011M11F	0.035

Ethernet connection accessories

Description	End fittings	Length m	Reference	Weight kg
Copper connecting cables, straight	1 IP 67 4-pin M12 connector and 1 RJ45 connector	1	XGSZ12E4501	–
		3	XGSZ12E4503	–
		10	XGSZ12E4510	–
Copper connecting cables, elbowed	2 IP 67 4-pin M12 connectors	1	XGSZ12E1201	–
		3	XGSZ12E1203	–
		10	XGSZ12E1210	–
		25	XGSZ12E1225	–
Copper connecting cables, elbowed	1 IP 67 4-pin M12 elbowed connector and 1 RJ45 connector	3	XGSZ22E4503	–
		10	XGSZ22E4510	–
Ethernet switch, M12 IP 67, ConneXium (1)	–	–	TCSESU051F0	0.210
Female M12/RJ45 adaptor	Ethernet connection	–	TCSEAAF11F13F00	–

“Do it Yourself” Ethernet copper cable and connectors

The “Do it Yourself” ConneXium range enables Ethernet copper connecting cables to be made up to the required length, on site. They are intended for connection to the Ethernet 110/100 Mbps network.

The maximum length of connecting cables made up in this way is 80 m. They are quick to assemble using only a knife and ordinary wire cutters (no special tool is required).

Description	Characteristics	Length (m)	Reference	Weight kg
Ethernet copper cable	Conforms to current standards and approvals	300	TCSECN300R2	–
RJ45 connector	Conforms to EIA/TIA-568-D	–	TCSEK3MDS	–
M12 connector	Conforms to IEC 60176-2-101	–	TCSEK1MDRS	–

Power supplies (Schneider Electric)

Description	Output voltage	Nominal power	Nominal current	Reference	Weight kg
	V $\overline{\text{---}}$	W	A		
100/240 V regulated power supply	24	7	0.3	ABL8MEM24003	0.180
		30	1.2	ABL8MEM24012	0.520

(1) Other ConneXium connection accessories: visit www.schneider-electric.com.

Radio frequency identification

13.56 MHz

XG range



XGSZ24



XGSZ3P

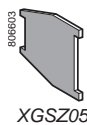
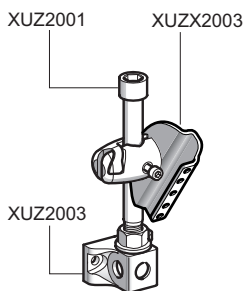

XGSZ05



XGSZCNF01

Connection accessories

Description	For use with	Length m	Reference	Weight kg
Female M8 pre-wired supply connector, 4-pin	XGCS850C201 compact smart antenna	2	XZCP0941L2	0.080
		5	XZCP0941L5	0.180
		10	XZCP0941L10	0.360
Female M12 pre-wired supply connector, A-coded, 4-pin	24 V $\overline{\text{DC}}$ supply to XGSZ33ETH and TCSAMT31FP boxes	2	XGSZ09L2	0.115
		5	XGSZ09L5	0.270
		10	XGSZ09L10	0.520
Female M12 connector, 5-pin, A-coded	–	–	XZCC12FDB50R	0.050
Male M12 connector, 5-pin, A-coded	–	–	XZCC12MDB50R	0.050
M12 supply connector, straight, A-coded, screw terminal	–	–	XZCC12FDM40B	0.020
Protective cap (Sold in lots of 10)	Female M12 connector	–	ETXSA12B (1)	0.013
Network terminator, male M12, 120 Ω	–	–	TM7ACTLA	0.010
Line adaptor RS 232C/RS 485 without modem signals Power supply: 18...30 V $\overline{\text{DC}}$ - Consumption: 20 mA Maximum transmission speed: 19,200 bauds Mounting on 35 mm $\overline{\text{DIN}}$ rail	–	–	XGSZ24	–

Mounting accessories

Description	For use with	Reference	Weight kg
Clip-on 90° mounting bracket	Flat form 40 smart antenna: XGCS4901201	XSZBC90	0.060
	Flat form 40 tags: XGHB44●345 XGHB221346 tags	XSZBE90	0.060
Clip-on mounting plate	Flat form 40 smart antenna: XGCS4901201	XSZBC00	0.025
	Flat form 40 tags: XGHB44●345 XGHB221346 tags	XSZBE00	0.025
Mounting plate	TCSAMT31FP and XGSZ33ETH connection boxes	XGSZ3P	0.195
3D fixing system (2)	XGFEC2525 field expander		
Support for M12 rod		XUZ2003	0.220
M12 rod		XUZ2001	0.050
Ball-joint mounted fixing bracket		XUZ2003	0.220

Accessories

Description	Sold in lots of	Reference	Weight kg
Key for screwing in/unscrewing cylindrical tag \varnothing 18 mm XGHB211●●	5	XGSZ05	0.011
RFID card For RFID reader address configuration	1	XGSZCNF01	0.005

(1) Schneider Electric product.

(2) To create a 3D fixing system, order: rod support XUZX2003, M12 rod XUZ2001 and ball-joint mounted fixing bracket XUZX2003.

RFID smart antennas

XGCS4901201

XGCS8901201

XGCS850C201

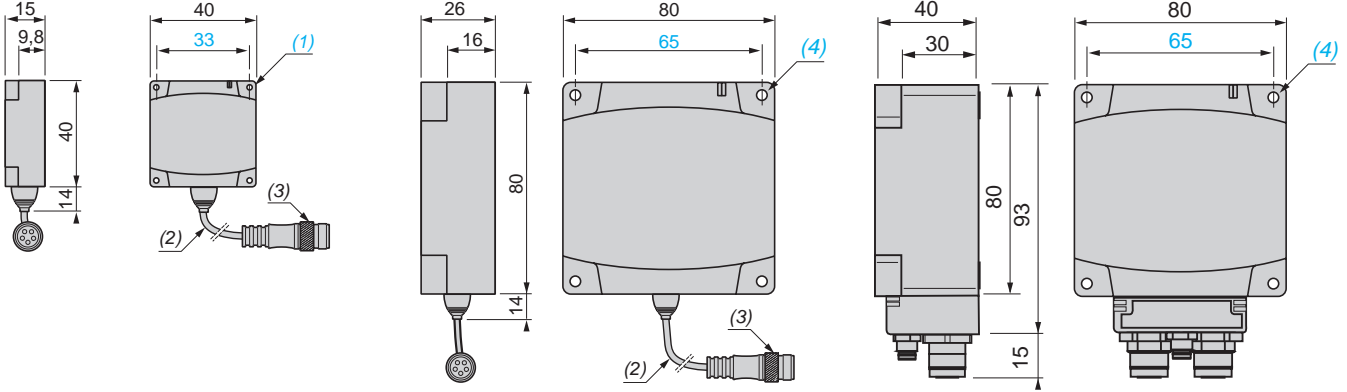

(1) 4 x Ø 4.5. For CHC type screws.

(3) Male 5-pin M12 connector, A-coded.

(2) Shielded cable (length: 20 cm).

(4) 4 x Ø 5.5. For CHC type screws.

Updatable code electronic tags

Square format tags

XGHB44●●

XGHB221346

Rectangular format tags

XGHB90E340

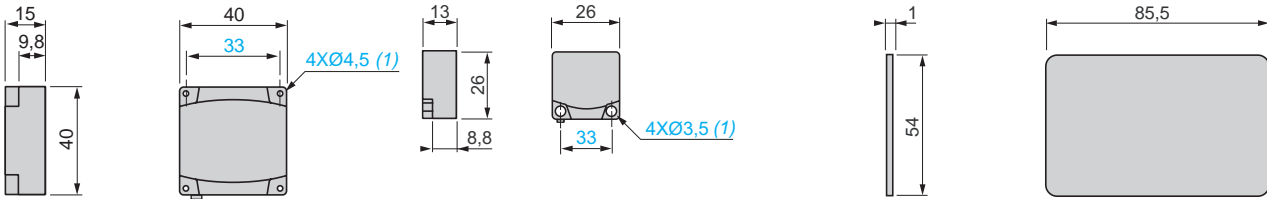

(1) For CHC type screws.

Cylindrical format tags

XGHB520246

XGHB32●●

XGHB211345

XGHB123345

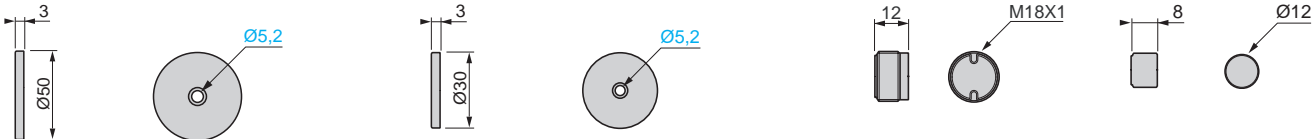

Connection boxes (1)

TCSAMT31FP tap-off box

XGSZ33ETH (Ethernet) box

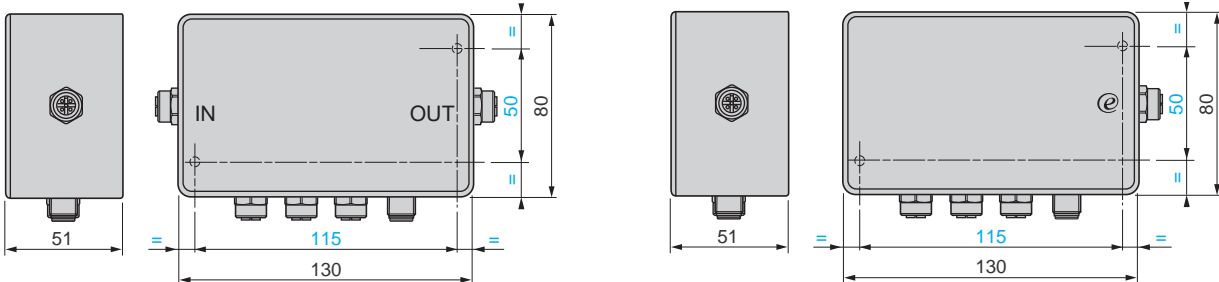

XGSZ33PDP (PROFIBUS DP) and XGSZ33EIP (EtherNet/IP) boxes

XGSZ3P mounting plate

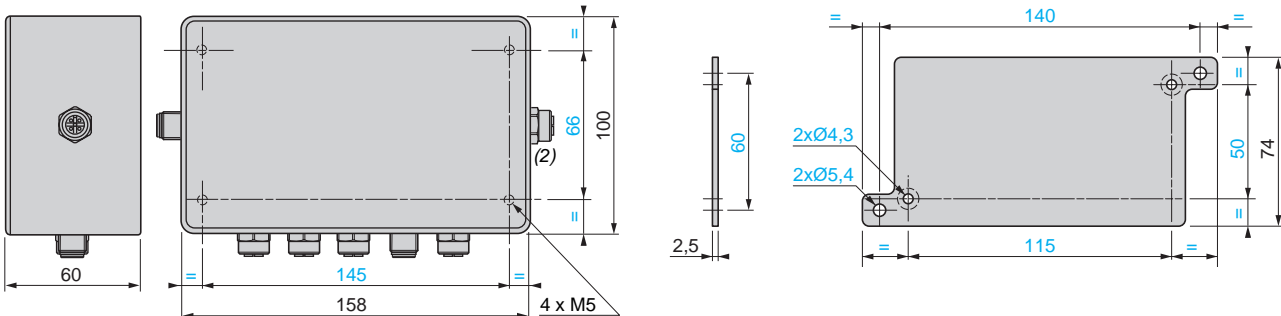

(1) Allow a 110 mm clearance zone for connecting the cables.

(2) This connector is only present on the PROFIBUS-DP box.

RFID handheld terminal

XGST2020 (30 mm deep)

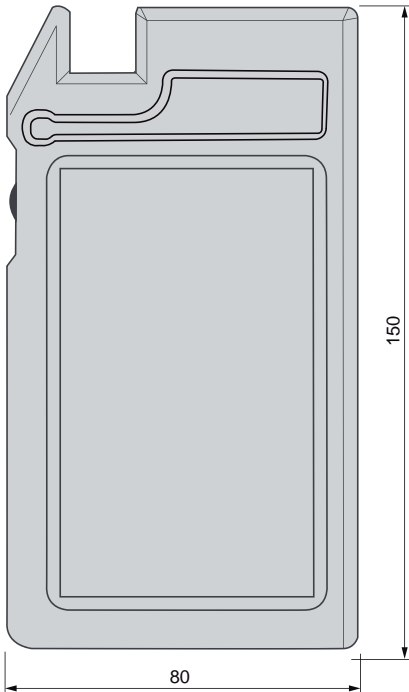

Field expanders

XGFEC540 conveying type

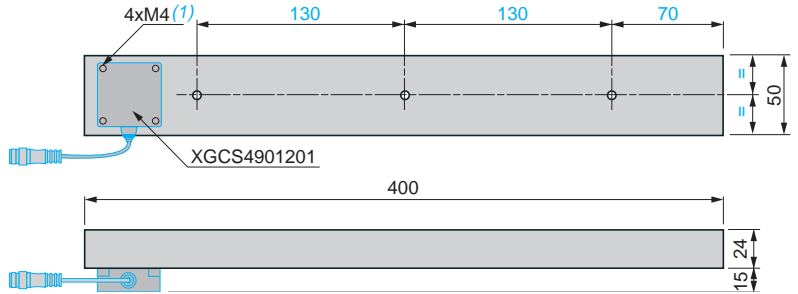

(1) 4 x M4 screws (included).

XGFEC2525 universal type

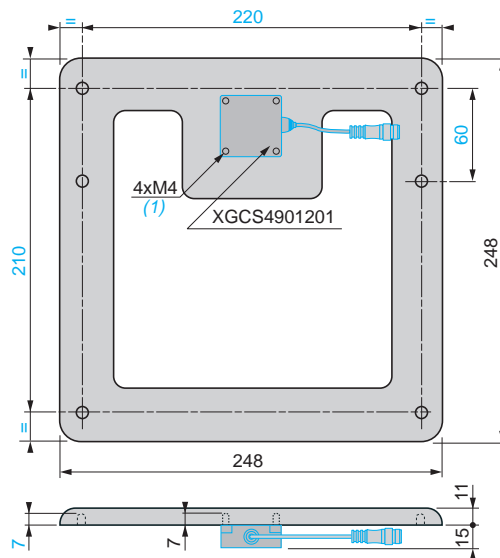

(1) 4 x M4 screws (included).

Mounting brackets

For XGCS49●● smart antennas and XGHB44●● tags
XSZBC90

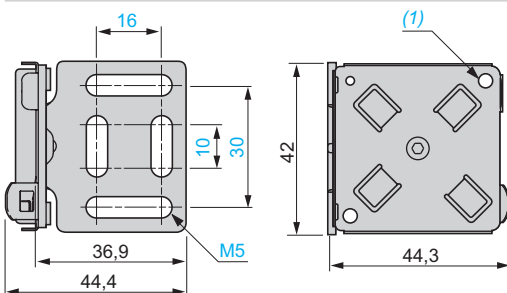

(1) 4 M4 x 14 screws (included).

Mounting plates

For XGCS49●● smart antennas and XGHB44●● tags
XSZBC00

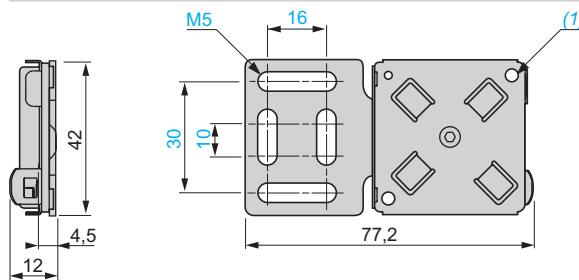

(1) 4 M4 x 14 screws (included).

For XGHB221346 tags

XSZBE90

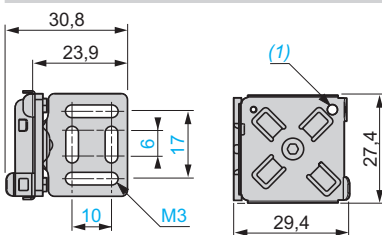

(1) 2 M3 x 12 screws (included).

For XGHB221346 tags

XSZBE00

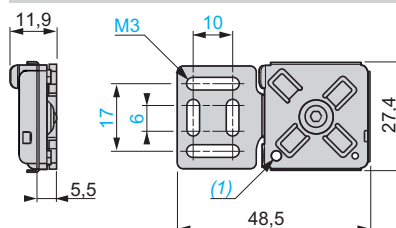

(1) 2 M3 x 12 screws (included).

Modbus connections

XGCS901201 smart antennas

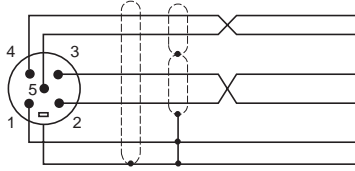

Pin no.
1
2
3
4
5
Connector casing

Modbus smart antenna signal	
1	Drain (Modbus-SHLD)
	+ 24 V $\overline{\text{---}}$
3	0 V/Modbus-GND
4	D0
5	D1
Connector casing	Shielding

TCSAMT31FP tap-off box

Socket to smart antenna cabling

Pin no.	Signal
1	–
2	Drain (Modbus-SHLD)
	+ 24 V $\overline{\text{---}}$
3	0 V/Modbus-GND
4	D0
5	D1

Socket to power supply cabling

Pin no.	Signal
1	+ 24 V $\overline{\text{---}}$
2	+ 24 V $\overline{\text{---}}$
3	0 V $\overline{\text{---}}$
4	0 V $\overline{\text{---}}$

Socket to another connection box cabling

Pin no.	Signal
1	Drain (Modbus-SHLD)
2	–
3	0 V/Modbus-GND
4	D0
5	D1

Socket to automation platform cabling

Pin no.	Signal
1	Drain (Modbus-SHLD)
2	–
3	0 V/Modbus-GND
4	D0
5	D1

Cable connections

TCSMCN1F cables and pre-wired connectors

Pin no.	Signal
1	–
2	Drain (Modbus-SHLD)
	+ 24 V $\overline{\text{---}}$
3	Black
	0 V/Modbus-GND
4	White
	D0
5	Blue
	D1
Connector casing	Shielding

XGSZ09L pre-wired connectors

Pin no.	Signal
1	Red
	+ 24 V $\overline{\text{---}}$
2	NC
3	Black
	0 V $\overline{\text{---}}$
4	NC

PROFIBUS-DP connections

PROFIBUS-DP box: XGSZ33PDP

Socket to smart antenna cabling

Pin no.	Signal
1	Earth
2	+ 24 V $\overline{\text{---}}$
3	0 V
4	D0
5	D1

Socket to power supply cabling

Pin no.	Signal
1	+ 24 V $\overline{\text{---}}$
2	+ 24 V $\overline{\text{---}}$
3	0 V
4	0 V

PROFIBUS-DP network connections

Input	Output	Pin no.	Signal	Description
1	1	1	VP	Line terminator polarization
2	2	2	RxD/TxD-N	Receive/transmit data (-) (red wire)
3	3	3	DGND	GND PROFIBUS
4	4	4	RxD/TxD-P	Receive/transmit data (+) (green wire)
5	5	5	Shielding	Shielding or earth
Connector casing	Shielding	Shielding	Shielding or earth	Shielding or earth

Ethernet connections

XGSZ33ETH and XGSZ33EIP Ethernet boxes

Socket to smart antenna cabling

Pin no.	Signal
1	Earth
2	+ 24 V $\overline{\text{---}}$
3	0 V
4	D0
5	D1



Socket to power supply cabling

Pin no.	Signal
1	+ 24 V $\overline{\text{---}}$
2	+ 24 V $\overline{\text{---}}$
3	0 V $\overline{\text{---}}$
4	0 V $\overline{\text{---}}$



XGSZ09L●● pre-wired connectors

Pin no.	Signal
1	Red + 24 V $\overline{\text{---}}$
2	NC
3	Black 0 V $\overline{\text{---}}$
4	NC



Socket to Ethernet connection

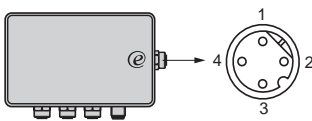

Socket to Ethernet cabling (M12 connectors)

Pin no.	Signal
1	TD +
2	TD -
3	RD +
4	RD -

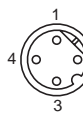

Ethernet compact smart antenna: XGCS850C201

Socket to Ethernet cabling (M12 connectors)

Pin no.	Signal
1	TD +
2	TD -
3	RD +
4	RD -

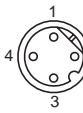

Socket to power supply cabling (M8 connector)

Pin no.	Signal
1	+ 24 V $\overline{\text{---}}$
2	NC
3	$\overline{\text{---}}$ 0 V
4	NC

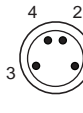

XZCP0941L●● pre-wired connectors (M8 connector)

Pin no.	Signal
1	Brown + 24 V $\overline{\text{---}}$
2	White NC
3	Blue $\overline{\text{---}}$ 0 V
4	Black NC

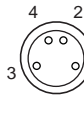

Ethernet cable connections

XGSZ12E45●● and XGSZ22E45●● cables

M12	Signal	Signal	RJ45
1	TD +	TD +	1
3	TD -	TD -	2
2	RD +	RD +	3
4	RD -	RD -	6

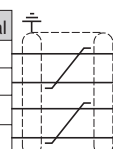

XGSZ12E12●● cables

M12	Signal	Signal	M12
1	TD +	TD +	1
3	TD -	TD -	3
2	RD +	RD +	2
4	RD -	RD -	4

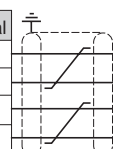

Dialogue zones of RFID smart antennas

XGCS4901201

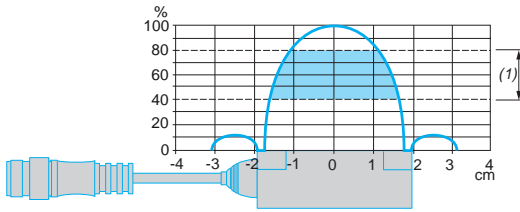

XGCS8901201 and XGCS850C201

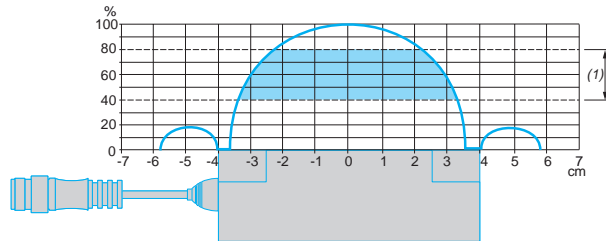

(1) Recommended movement zone: between 0.4 and 0.8 Pn.

Dialogue zones for field expanders

XGFEC540 + XGHB90E340 or XGHB520246 tag

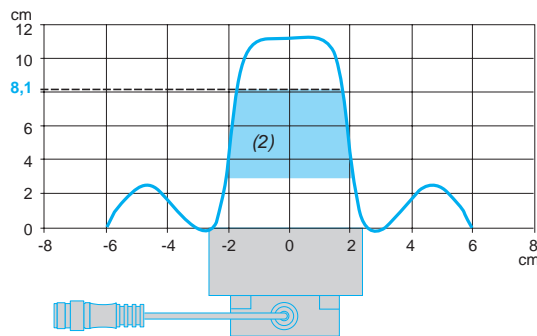
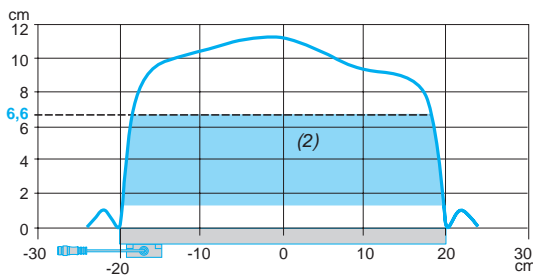

XGFEC540 + XGHB320345 tag

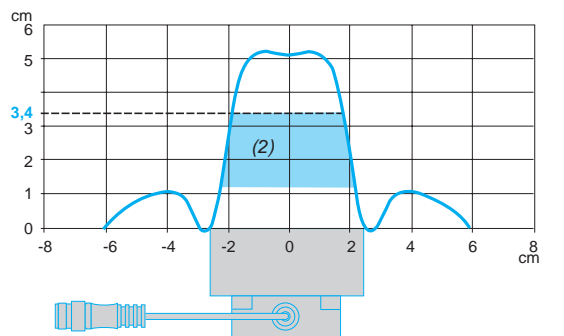
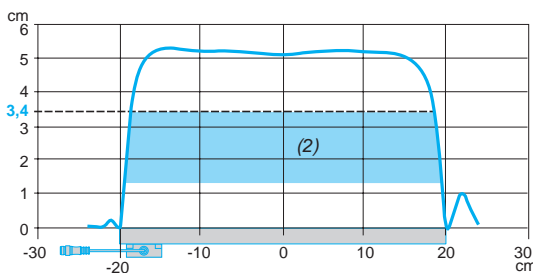

XGFEC2525 + XGHB90E340 or XGHB520246 tag

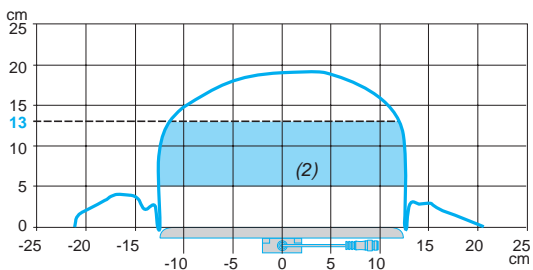

XGFEC2525 + XGHB320345 tag

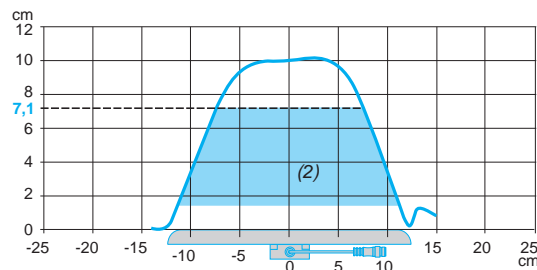

(2) Recommended working zone.

Angular positioning between smart antenna and tag

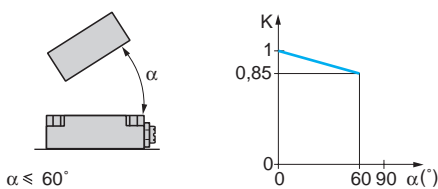

K = correction coefficient to be applied to the nominal sensing distance. Read distance = nominal sensing distance $\times K$.

Minimum mounting distances between system components

Distance between smart antennas

Minimum distance between 2 identical smart antennas according to their positioning and type of tag used (mm)

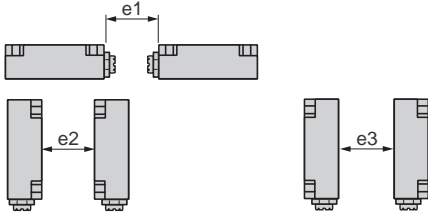

Tag	XGCS4901201 smart antenna (form 40)			XGCS8●● smart antennas (form 80)		
	e1	e2	e3	e1	e2	e3
XGHB90E340	310	550	120	430	750	280
XGHB520246						
XGHB221346	200	320	100	280	530	260
XGHB320●●●	140	360	110	310	540	240
XGHB211345	210	180	60	200	370	170
XGHB123345						
XGHB44●●●	90	190	30	310	400	160

Distance between field expanders

Minimum distance between 2 identical field expanders according to their positioning and type of tag used (mm)

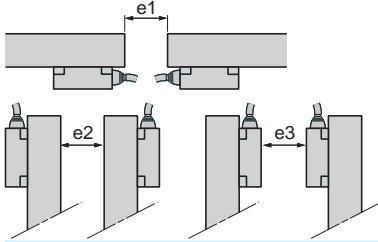

Tag	XGFEC540 field expander			XGFEC2525 field expander		
	e1	e2	e3	e1	e2	e3
XGHB90E340	195	285	195	570	890	960
XGHB520246						
XGHB320345	420	540	450	720	1275	1200

Distance between tags

Minimum distance between 2 identical tags according to their positioning and type of smart antenna used (mm)

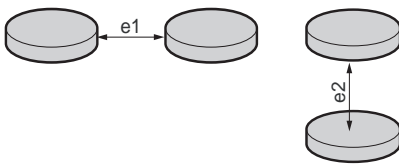

Tag	XGCS4901201 smart antenna (form 40)		XGCS8●● smart antenna (form 80)	
	e1	e2	e1	e2
XGHB90E340	35	60	110	140
XGHB520246				
XGHB221346	50	10	120	50
XGHB320345	70	50	190	60
XGHB440245				
XGHB320246				
XGHB211345	40	10	120	20
XGHB123345				
XGHB444345	20	10	70	40
XGHB440845	30	10	60	10
XGHB441645				
XGHB443245				

Minimum permissible mounting distances in a metal structure

Smart antennas and tags

XGCS49/XGCS89/XGCS85 smart antennas and XGHB221346/XGHB44●● tags

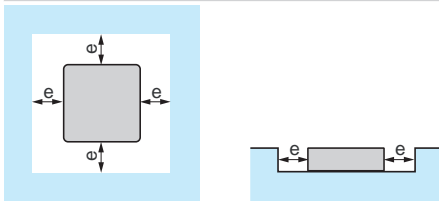

$e \geq 20$ mm.

$e \geq 20$ mm.

XGHB32●● and XGHB52●● tags

No metal parts within 15 mm of the tag.

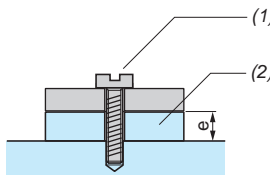

$e \geq 15$ mm.

XGHB90E340, XGHB211345, XGHB123345 tags

No metal parts within 25 mm of the tag.

Tags	Nominal sensing distance Pn (mm)	
	XGCS49	XGCS89/S85
XGHB90E340	70	100
XGHB520246		
XGHB221346	40	55
XGHB320345	48	65
XGHB211345	18	20
XGHB123345		
XGHB444345	33	48
XGHB440245	45	65
XGHB440845	25	39
XGHB441645		
XGHB443245		

Reduced sensing distance in the presence of metal (mm)

XGCS49	XGCS89/S85
58	80
30	33
45	56
16	15
28	34
30	45
20	28

Field expanders

	e (mm)	h (mm)
XGFEC540	15	30
XGFEC2525	0	75

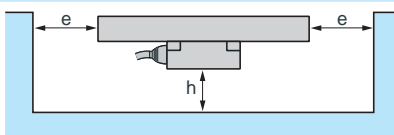

(1) Tightening torque ≤ 1 Nm/0.74 lb-ft.
(2) Insulation material.

A		XGSZ22E4510	22
ABL8MEM24003	22	XGSZ24	23
ABL8MEM24012	22	XGSZ33EIP	21
E		XGSZ33ETH	21
ETXSA12B	23	XGSZ33PDP	21
T		XGSZCNF01	23
TCSAMT31FP	21	XGSZK1	21
TCSCTN011M11F	22	XGW4F111	20
TCSEAAF11F13F00	22	XSZBC00	23
TCSECN300R2	22	XSZBC90	23
TCSEK1MDRS	22	XSZBE00	23
TCSEK3MDS	22	XSZBE90	23
TCSESU051F0	22	XUZ2001	23
TCSMCN1F2	22	XUZ2003	23
TCSMCN1F5	22	XUZX2003	23
TCSMCN1F9M2P	22	XZCC12FDB50R	23
TCSMCN1F10	22	XZCC12FDM40B	23
TCSMCN1FQM2	22	XZCC12MDB50R	23
TCSMCN1M1F1	22	XZCP0941L2	23
TCSMCN1M1F2	22	XZCP0941L5	23
TCSMCN1M1F5	22	XZCP0941L10	23
TCSMCN1M1F10	22		
TM7ACTLA	23		
TSXCSA100	22		
TSXCSA200	22		
TSXCSA500	22		
X			
XGCS850C201	20		
XGCS4901201	20		
XGCS8901201	20		
XGFEC540	21		
XGFEC2525	21		
XGHB90E340	20		
XGHB123345	20		
XGHB211345	20		
XGHB221346	20		
XGHB320246	20		
XGHB320345	20		
XGHB440245	20		
XGHB440845	20		
XGHB441645	20		
XGHB443245	20		
XGHB444345	20		
XGHB520246	20		
XGST2BA	21		
XGST2FP	21		
XGST2020	21		
XGST2422	21		
XGSZ3P	23		
XGSZ05	23		
XGSZ09L2	23		
XGSZ09L5	23		
XGSZ09L10	23		
XGSZ12E1201	22		
XGSZ12E1203	22		
XGSZ12E1210	22		
XGSZ12E1225	22		
XGSZ12E4501	22		
XGSZ12E4503	22		
XGSZ12E4510	22		
XGSZ22E4503	22		

Schneider Electric Industries SAS

Head Office
35, rue Joseph Monier
F-92500 Rueil-Malmaison
France

www.tesensors.com

The information provided in this documentation contains general descriptions and/or technical characteristics of the performance of the products contained herein. This documentation is not intended as a substitute for and is not to be used for determining suitability or reliability of these products for specific user applications. It is the duty of any such user or integrator to perform the appropriate and complete risk analysis, evaluation and testing of the products with respect to the relevant specific application or use thereof. Neither Schneider Electric nor any of its affiliates or subsidiaries shall be responsible or liable for misuse of the information contained herein.

Design: Schneider Electric
Photos: Schneider Electric

November 2018 - V3.0

DIA4ED2140601EN