Photo-electric sensors

XU range

Material handling & working, packaging

Catalogue



Simply easy!™

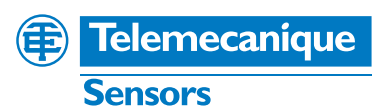

Photo-electric sensors

XU range

XU range, general purpose

- XUM, miniature design, plastic
 - Thru-beam system with adjustable sensitivity page 2
 - Polarised reflex system with adjustable sensitivity page 3
 - Background suppression system with adjustable sensitivity page 3
 - Diffuse system with adjustable sensitivity page 4
 - Accessories for all XUM miniature sensors page 5
 - Characteristics page 6
 - Schemes page 7
 - Curves page 8
 - Description, dimensions – Systems page 12
 - Dimensions – Accessories page 13
- XUB, cylindrical miniature design 18, plastic or metal
 - Thru-beam system with adjustable sensitivity, plastic page 14
 - Thru-beam system with adjustable sensitivity, metal page 15
 - Diffuse system with adjustable sensitivity, plastic page 16
 - Diffuse system with adjustable sensitivity, metal page 17
 - Polarised reflex system with adjustable sensitivity, plastic page 18
 - Polarised reflex system with adjustable sensitivity, metal page 19
 - Characteristics page 20
 - Schemes page 21
 - Curves page 23
 - Dimensions page 28
- XUN, hybrid miniature design, plastic
 - Thru-beam system with adjustable sensitivity page 32
 - Diffuse system with adjustable sensitivity page 33
 - Polarised reflex system with adjustable sensitivity page 34
 - Characteristics page 35
 - Schemes page 36
 - Curves page 38
 - Dimensions page 41

XU range application

- General presentation page 44
- XU Contrast, for marking detection
 - Contrast mark reader sensors, white light page 46
 - Contrast mark reader sensors, RGB light page 46
 - Contrast mark reader sensors, laser light page 46
 - Characteristics page 47
 - Schemes page 48
 - Curves page 49
 - Dimensions page 49
- XU Background suppression system (BGS), for very dark object detection
 - Adjustable blue light sensors page 50
 - Fixed blue light sensors, miniature page 50
 - Fixed blue light sensors, sub-miniature page 50
 - Adjustable blue light sensors (potentiometer) page 50
 - Characteristics page 51
 - Schemes page 52
 - Curves page 54
 - Dimensions page 55

■ XU Laser, for accurate detection	
□ Lasers sensors, diffuse mode detection	page 56
□ Lasers sensors, BGS mode detection	page 56
□ Lasers sensors, reflex mode detection	page 56
□ Characteristics	page 57
□ Schemes	page 58
□ Dimensions	page 59
□ Curves	page 60
■ XU for colour object detection	
□ Colour sensors, white light, multiple colour	page 62
□ Colour sensors, RGB light, unique colour	page 62
□ Characteristics	page 62
□ Schemes	page 63
□ Curves	page 63
□ Dimensions	page 63
■ XU for transparent object detection	
□ Polarised reflex system	page 64
□ BGS mode detection, adjustable	page 64
□ BGS mode detection, not adjustable	page 64
□ BGS mode detection, compact	page 64
□ Characteristics	page 65
□ Schemes	page 66
□ Dimensions	page 67
□ Curves	page 68

XU accessories

■ IO-Link Master	page 70
■ Fixing brackets	page 74
■ Mounting rings	page 74
■ Reflectors	page 78
■ Cabling accessories	page 80
□ Pre-wired connectors, references	page 80
□ Jumper cables, references	page 81
□ Pre-wired connectors M8 and M12, characteristics	page 82
□ Shielded cables with pre-wired connectors M12, characteristics	page 84
□ Jumper cables M12-M12, characteristics	page 86
□ Shielded jumper cables M12-M12, characteristics	page 87
□ Jumper cables M8-M8 and M8-M12, characteristics	page 88

Index

■ Product reference index	page 90
---------------------------	---------

Photo-electric sensors

XUM, general purpose, single mode function

Miniature design, plastic

Three-wire DC, solid-state output



XUM2A●XBL2, XUM2A●XBL03M8,
XUM2A●XBL03M12



XUM2A●XBM8

Thru-beam system with adjustable sensitivity

Max./ operating sensing distance (Sn)	Function	Output	Connection	Reference	Weight kg
Transmitter + receiver IO-Link (1)					
30 m/24 m	Light ON (NC)/ Dark ON (NO) configuration by IO Link	Autodetect PNP/NPN	M8 connector (4-pin)	XUM2APYBM8	0 010
			M12 connector (4-pin)	XUM2APYBL03M12	-

Transmitter + receiver						
30 m/24 m	Light ON (NC)/ Dark ON (NO) configuration by potentiometer	PNP	Pre-cabled (L = 2 m)	XUM2APXBL2	0 096	
			M8 connector (4-pin)	XUM2APXBM8	0 026	
				XUM2APXBL03M8 (1)		-
		M12 connector (4-pin)	XUM2APXBL03M12 (1)		-	
			NPN	Pre-cabled (L = 2 m)	XUM2ANXBL2	0 096
				M8 connector (4-pin)	XUM2ANXBM8	0 026
XUM2ANXBL03M8 (1)		-				
XUM2ANXBL03M12 (1)		-				

Transmitter only					
30 m/24 m			Pre-cabled (L = 2 m)	XUM2AKXBL2T	0 063
			M8 connector (4-pin)	XUM2AKXBM8T	0 010
				XUM2AKXBL03M8T (1)	
			XUM2AKXBL03M12T (1)		-

Receiver only IO-Link (1)					
30 m/24 m	Light ON (NC)/ Dark ON (NO) configuration by IO-Link	Autodetect PNP/NPN	M8 connector (4-pin)	XUM2APYBM8R	0 010
			M12 connector (4-pin)	XUM2APYBL03M12R (1)	-

Receiver only						
30 m/24 m	Light ON (NC)/ Dark ON (NO) configuration by potentiometer	PNP	Pre-cabled (L = 2 m)	XUM2APXBL2R	0 063	
			M8 connector (4-pin)	XUM2APXBM8R	0 010	
				XUM2APXBL03M8R (1)		-
		M12 connector (4-pin)	XUM2APXBL03M12R (1)		-	
			NPN	Pre-cabled (L = 2 m)	XUM2ANXBL2R	0 063
				M8 connector (4-pin)	XUM2ANXBM8R	0 010
XUM2ANXBL03M8R (1)		-				
XUM2ANXBL03M12R (1)		-				

Accessories

For all XUM miniature sensors

See page 5 .

For thru-beam system

See page 5 .

IO-Link Master (2)

See page 70 .

Fixing and other accessories

See page 74 .

Cabling accessories

See page 80 .

(1) Available 4th quarter 2024.

(2) Available 2nd quarter 2024.

Photo-electric sensors

XUM, general purpose, single mode function

Miniature design, plastic

Three-wire DC, solid-state output



XUM9A•XBL2



XUM9A•XBM8

Polarised reflex system with adjustable sensitivity

Max./operating sensing distance (Sn)	Function	Output	Connection	Reference	Weight kg
Sensors IO-Link (1)					
8 m/6.7 m with reflector XUZC50	Light ON (NC)/ Dark ON (NO) configuration by IO-Link	Autodetect PNP/NPN	M8 connector (4-pin)	XUM9APYBM8	0 010
			M12 connector (4-pin)	XUM9APYBL03M12 (1)	–
Standard sensors					
8 m/6.7 m with reflector XUZC50	Light ON (NC)/ Dark ON (NO) configuration by potentiometer	PNP	Pre-cabled (L = 2 m)	XUM9APXBL2	0 063
			M8 connector (4-pin)	XUM9APXBM8	0 010
				XUM9APXBL03M8 (1)	–
			M12 connector (4-pin)	XUM9APXBL03M12 (1)	–
		NPN	Pre-cabled (L = 2 m)	XUM9ANXBL2	0 063
			M8 connector (4-pin)	XUM9ANXBM8	0 010
				XUM9ANXBL03M8 (1)	–
			M12 connector (4-pin)	XUM9ANXBL03M12 (1)	–



XUM8A•XBL2



XUM8A•XBM8

Background suppression system with adjustable sensitivity

Max./operating sensing distance (Sn)	Function	Output	Connection	Reference	Weight kg
300 mm/200 mm (white object or paper)	Light ON (NO)/ Dark ON (NC) configuration by potentiometer	PNP	Pre-cabled (L = 2 m)	XUM8APXBL2	0 063
			M8 connector (4-pin)	XUM8APXBM8	0 010
		NPN	Pre-cabled (L = 2 m)	XUM8ANXBL2	0 063
			M8 connector (4-pin)	XUM8ANXBM8	0 010

Accessories

For all XUM miniature sensors

See page 5 .

IO-Link Master (2)

See page 70 .

Fixing and other accessories

See page 74 .

Cabling accessories

See page 80 .

(1) Available 4th quarter 2024.(2) Available 2nd quarter 2024.

Photo-electric sensors

XUM, general purpose, single mode function

Miniature design, plastic

Three-wire DC, solid-state output



XUM4A●XBL2



XUM4A●XBM8



XUM6A●XBL2



XUM6A●XBM8



XUM5A●XBL2



XUM5A●XBM8

Diffuse system with adjustable sensitivity

Max./operating sensing distance (Sn)	Function	Output	Connection	Reference	Weight kg
Diffuse short range					
0.25 m/0.17 m	Light ON (NO)/ Dark ON (NC) configuration by potentiometer	PNP	Pre-cabled (L = 2 m)	XUM4APXBL2	0 063
			M8 connector (4-pin)	XUM4APXBM8	0 010
			M12 connector (4-pin)	XUM4APXBL03M8 (1)	–
	NPN	Pre-cabled (L = 2 m)	XUM4ANXBL2	0 063	
		M8 connector (4-pin)	XUM4ANXBM8	0 010	
		M12 connector (4-pin)	XUM4ANXBL03M12 (1)	–	

Diffuse medium range IO-Link (1)

1.1 m/0.8 m	Light ON (NO)/ Dark ON (NC) configuration by IO-Link	Autodetect PNP/NPN	M8 connector (4-pin)	XUM6APYBM8	–
			M12 connector (4-pin)	XUM6APYBL03M12	–

Diffuse medium range

1.1 m/0.8 m	Light ON (NO)/ Dark ON (NC) configuration by potentiometer	PNP	Pre-cabled (L = 2 m)	XUM6APXBL2	0 063
			M8 connector (4-pin)	XUM6APXBM8	0 010
			M12 connector (4-pin)	XUM6APXBL03M12 (1)	–
	NPN	Pre-cabled (L = 2 m)	XUM6ANXBL2	0 063	
		M8 connector (4-pin)	XUM6ANXBM8	0 010	
		M12 connector (4-pin)	XUM6ANXBL03M12 (1)	–	

Diffuse long range IO-Link (1)

1.9 m/1.5 m	Light ON (NO)/ Dark ON (NC) configuration by IO-Link	Autodetect PNP/NPN	M8 connector (4-pin)	XUM5APYBM8	–
			M12 connector (4-pin)	XUM5APYBL03M12	–

Diffuse long range

1.9 m/1.5 m	Light ON (NO)/ Dark ON (NC) configuration by potentiometer	PNP	Pre-cabled (L = 2 m)	XUM5APXBL2	0 063
			M8 connector (4-pin)	XUM5APXBM8	0 010
			M12 connector (4-pin)	XUM5ANXBL03M12 (1)	–
	NPN	Pre-cabled (L = 2 m)	XUM5ANXBL2	0 063	
		M8 connector (4-pin)	XUM5ANXBM8	0 010	
		M12 connector (4-pin)	XUM5ANXBL03M12 (1)	–	

Accessories for XU sensors

For all XUM miniature sensors

See page 5 .

IO-Link Master (2)

See page 70 .

Fixing and other accessories

See page 74 .

Cabling accessories

See pages 80 to 85 .

(1) Available 4th quarter 2024.

(2) Available 2nd quarter 2024.



XUZASM05



XUZDVM●●



XUZDHM●●



XUZDRM●●

Accessories for all XUM miniature sensors

Setting-up accessory

Description	For use with sensors	Reference	Weight kg
Air blower mounting block (1) for cleaning the sensitive face of the sensor, using compressed air . Supplied with 2 mounting screws (M3 x 20), 1 air supply port plugging screw for the unused port (of 2 available) and 1 gasket .	XUM●A●XBL2 XUM●A●XBM8	XUZASM05	0 030

Accessories for thru-beam system

Diaphragms

Description	Dimensions	Sensing distance	Reference	Weight kg
	mm	m		
Vertical diaphragm Sold in lots of 2	0.5 x 6.4	1	XUZDVM05	0 003
	1 x 6.4	1.5	XUZDVM10	0 003
	2 x 6.4	3.5	XUZDVM20	0 003
Horizontal diaphragm Sold in lots of 2	0.5 x 6.4	0.7	XUZDHM05	0 003
	1 x 6.4	1.5	XUZDHM10	0 003
	2 x 6.4	3	XUZDHM20	0 003
Round diaphragm Sold in lots of 2	0.5 x 6.4	0.08	XUZDRM05	0 003
	1 x 6.4	0.3	XUZDRM10	0 003
	2 x 6.4	1.2	XUZDRM20	0 003

Accessories for XU sensors

IO-Link Master (2)

See page 70 .

Fixing and other accessories

See page 74 .

Cabling accessories

See pages 80 to 85 .

(1) To order these references, please contact our Customer Care Centre.

(2) Available 2nd quarter 2024.

Photo-electric sensors

XUM, general purpose, single mode function

Miniature design, plastic

Three-wire DC, solid-state output

Characteristics				XUM●A●XBM8	XUM●A●XBL03M●	XUM●A●XBL2
Sensor type						
Product certifications				CE, UKCA, cULus EAC, RCM (pending)		
Connection	Connector			M8	–	–
	Pigtail			–	Length: 0.3 m	–
	Pre-cabled			–	–	Length: 2 m
Configuration				IO-Link Potentiometer	IO-Link Potentiometer	Potentiometer
Nominal sensing distance Sn	Thru-beam system	XUM2	m	30 (with excess gain = 1) 24 (with excess gain = 2)		
	Polarised reflex system (using a 50 x 50 mm reflector XUZC50)	XUM9	m	0.05...8 (with excess gain = 1) 0.05...6.7 (with excess gain = 2)		
	Background suppression system	XUM8	mm	4 . 300: White paper or object .Sn (90%) 5 . 265: Grey object .Sn (18%) 8 . 200: Black object .Sn (6%)		
	Diffuse system (using a white paper 200 x 200 mm)	XUM4	m	0.25 (with excess gain = 1) 0.17 (with excess gain = 2)		
		XUM5	m	1.9 (with excess gain = 1) 1.5 (with excess gain = 2)		
	XUM6	m	1.1 (with excess gain = 1) 0.8 (with excess gain = 2)			
Hysteresis				2% < H < 20% at Sn		
Type of transmission	Red			Thru-beam system XUM2 Polarised reflex system XUM9 Background suppression system XUM8 Diffuse system XUM6		
	Infrared			Diffuse system XUM4 and XUM5		
Degree of protection	Conforming to IEC 60529			IP65, IP67		
Storage temperature			°C	-40...+70		
Operating temperature			°C	-30...+55		
Materials	Case			PBT		
	Lens			PMMA		
	Display			PC		
	Cable			–	–	PVC
Vibration resistance	Conforming to IEC 60068-2-6			Frequency range: 10 to 500 Hz Acceleration: 9 gn		
Shock resistance	Conforming to IEC 60068-2-27			Peak acceleration: 100 gn Duration of the pulse: 11 ms		
Indicator lights	Output state			Yellow LED		
	Stability			Green LED (XUM4, XUM5, XUM6, XUM8, XUM9)		
	Power on			Green LED (XUM2)		
Rated supply voltage			V	12 . 24 --- with protection against reverse polarity		
Voltage limits (including ripple)			V	12 . 24 ---		
Current consumption, no-load			mA	< 20 max.		
Switching capacity			mA	100		
Voltage drop, closed state			V	≤ 2		
Maximum switching frequency			Hz	1000		
Delays	First-up		ms	< 100		
	Response		ms	0.5		
	Recovery		ms	0.5		

Photo-electric sensors

XUM, general purpose, single mode function

Miniature design, plastic

Three-wire DC, solid-state output

Wiring schemes

Thru-beam system

M8 and M12 connector - 4-pin IO-Link

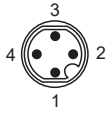

Pin	Signal	Definition
1	+	+ 24 V $\overline{\text{DC}}$
2	IN	+ = NO - = NC Open = NO
3	-	0 V $\overline{\text{DC}}$
4	Q	Switching signal (SIO)
	C	IO-Link communication

Autodetect PNP/NPN or by IO-Link

XUM2APYBM8, XUM2APYBM8R

XUM2APYBL03M12, XUM2APYBL03M12R

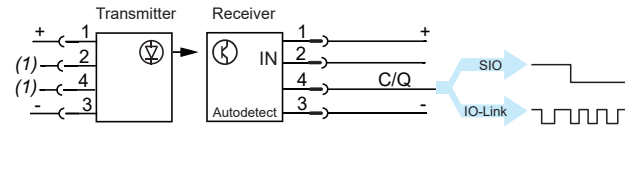

M8 and M12 connector - 4-pin

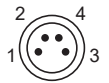

3 (-)	1 (+)	4 OUT/Output
-------	-------	--------------

PNP

XUM2APXBM8, XUM2APXBL03M8,
XUM2AKXBM8T, XUM2AKXBL03M8T,
XUM2APXBM8R, XUM2APXBL03M8R
XUM2APXBL03M12, XUM2AKXBL03M12T,
XUM2APXBL03M12R

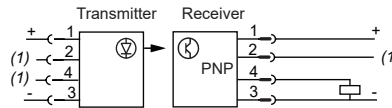

NPN

XUM2ANXBM8, XUM2ANXBL03M8,
XUM2ANXBM8R, XUM2ANXBL03M8R
XUM2ANXBL03M12,
XUM2ANXBL03M12R

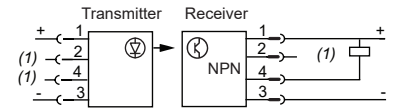

Pre-cabled - 3-wire

(-) BU (Blue)

(+) BN (Brown)

OUT/Output BK (Black)

PNP

XUM2APXBL2, XUM2AKXBL2T,
XUM2APXBL2R

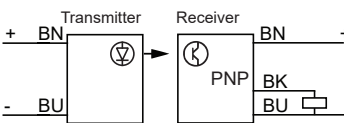

NPN

XUM2ANXBL2, XUM2ANXBL2R

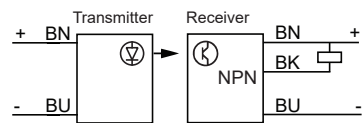

Polarised reflex, background suppression and diffuse systems

M8 and M12 connector - 4-pin IO-Link

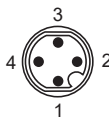

Pin	Signal	Definition
1	+	+ 24 V $\overline{\text{DC}}$
2	IN	+ = NO - = NC Open = NO
3	-	0 V $\overline{\text{DC}}$
4	Q	Switching signal (SIO)
	C	IO-Link communication

XUM●APYBL03M12, XUM●APYBM8

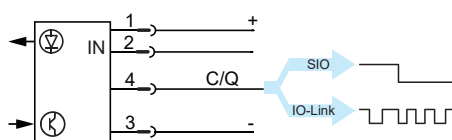

M8 and M12 connector - 4-pin

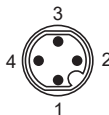

Pin	Signal	Definition
1	+	+ 24 V $\overline{\text{DC}}$
2	IN	+ = NO - = NC Open = NO
3	-	0 V $\overline{\text{DC}}$
4	Q	Switching signal (SIO)

PNP

XUM●APXBL03M12, XUM●APXBM8,
XUM●APXBL03M8

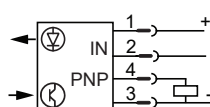

NPN

XUM●ANXBL03M12

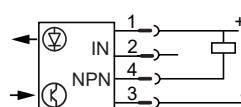

Pre-cabled - 3-wire

(-) BU (Blue)

(+) BN (Brown)

OUT/Output BK (Black)

PNP

XUM●APXBL2

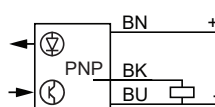

NPN

XUM●ANXBL2

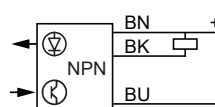

(1) Not connected.

Photo-electric sensors

XUM, general purpose, single mode function

Miniature design, plastic

Three-wire DC, solid-state output

Detection curves

Thru-beam system: XUM2

Lateral displacement

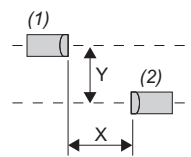
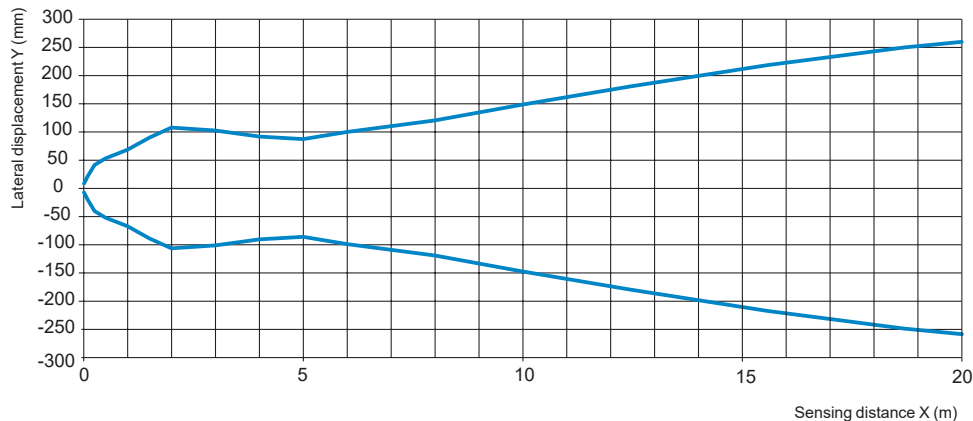

(1): Transmitter
(2): Receiver

Light beam diameter

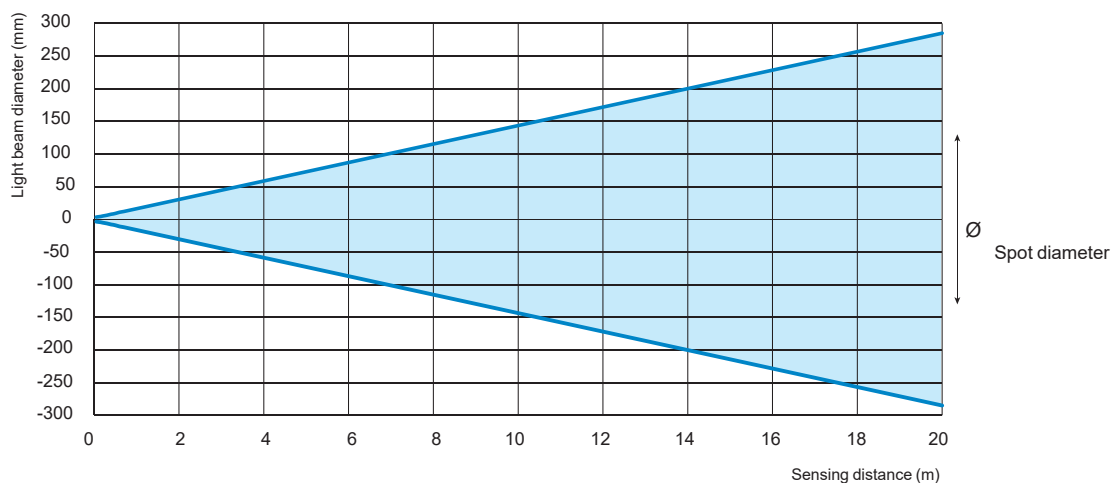

Excess gain

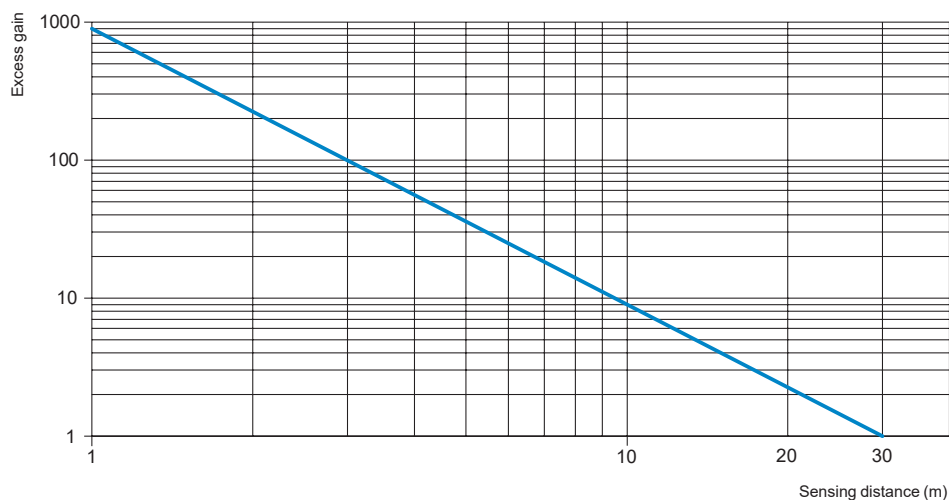

Photo-electric sensors

XUM, general purpose, single mode function

Miniature design, plastic

Three-wire DC, solid-state output

Detection curves

Polarised reflex system: XUM9

Reflector angle

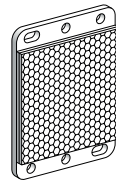
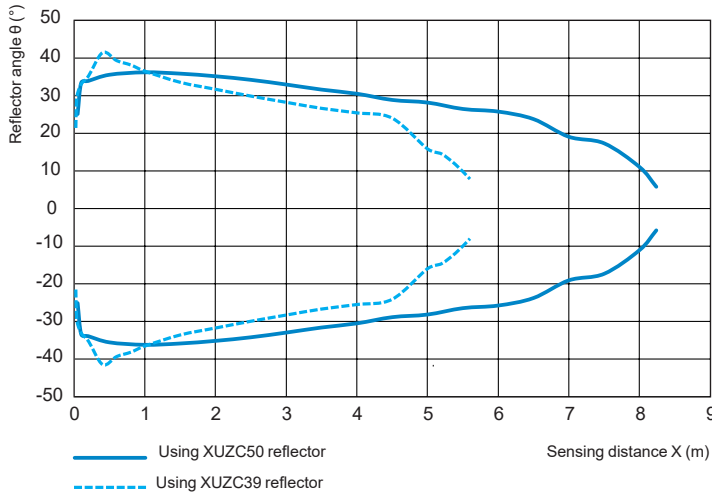

XUZC50



XUZC39

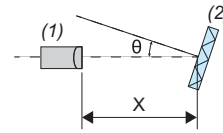

(1): Sensor
 (2): Reflector
 θ : Reflector angle (°)
 X: Sensing distance (m)

Lateral displacement

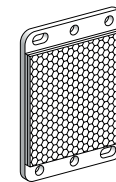
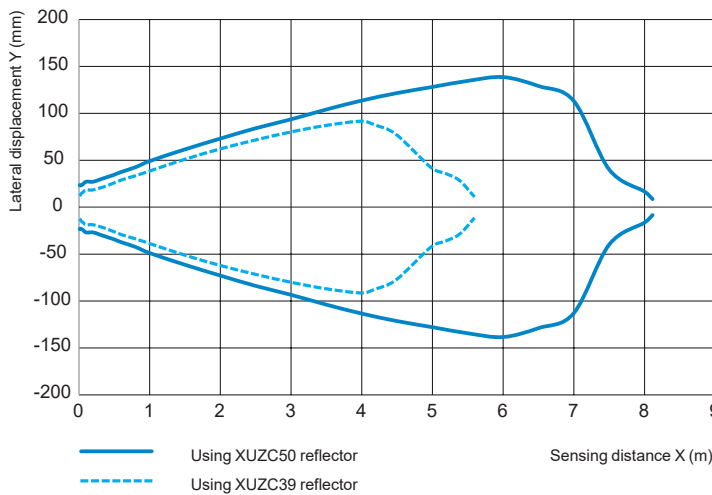

XUZC50



XUZC39

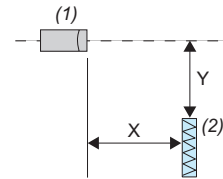

(1): Sensor
 (2): Reflector
 Y: Lateral displacement (mm)
 X: Sensing distance (m)

Excess gain

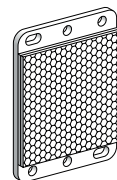
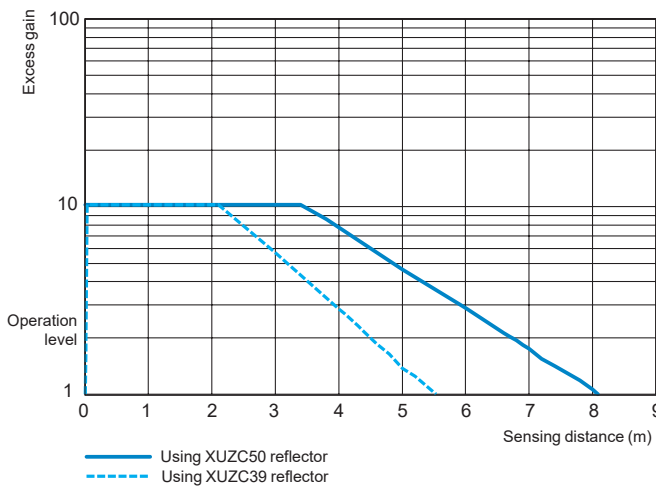

XUZC50



XUZC39

Photo-electric sensors

XUM, general purpose, single mode function

Miniature design, plastic

Three-wire DC, solid-state output

Detection curves (continued)

Background suppression system: XUM8

Lateral displacement (preset 100 mm)

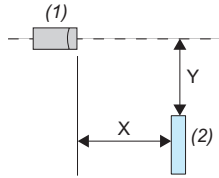
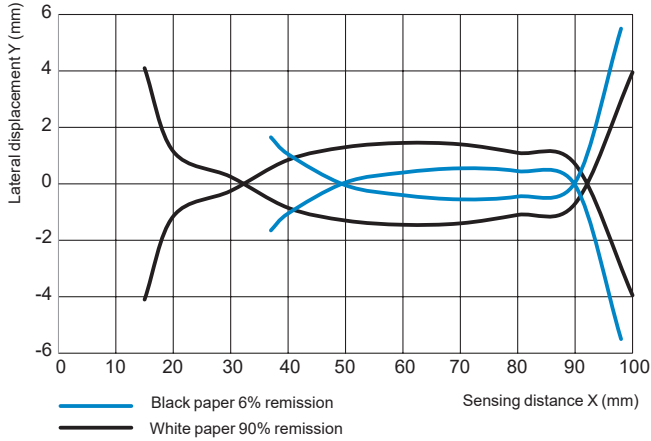

(1): Sensor
 (2): Object (200 mm square white and black mat paper)
 X: Sensing distance (mm)
 Y: Lateral displacement (mm)

Lateral displacement (preset 200 mm)

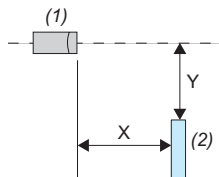
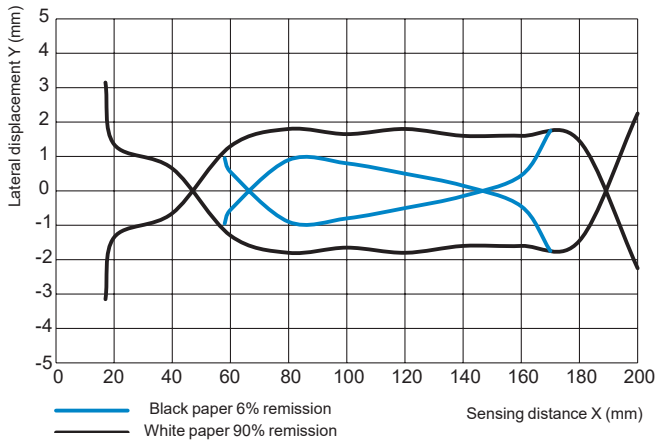

(1): Sensor
 (2): Object (200 mm square white and black mat paper)
 X: Sensing distance (mm)
 Y: Lateral displacement (mm)

Light beam diameter

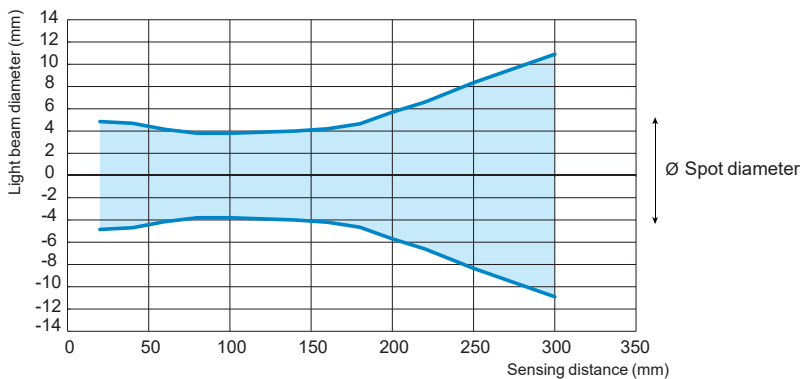

Minimum distance between the object to be detected and a white background

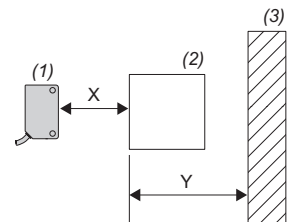
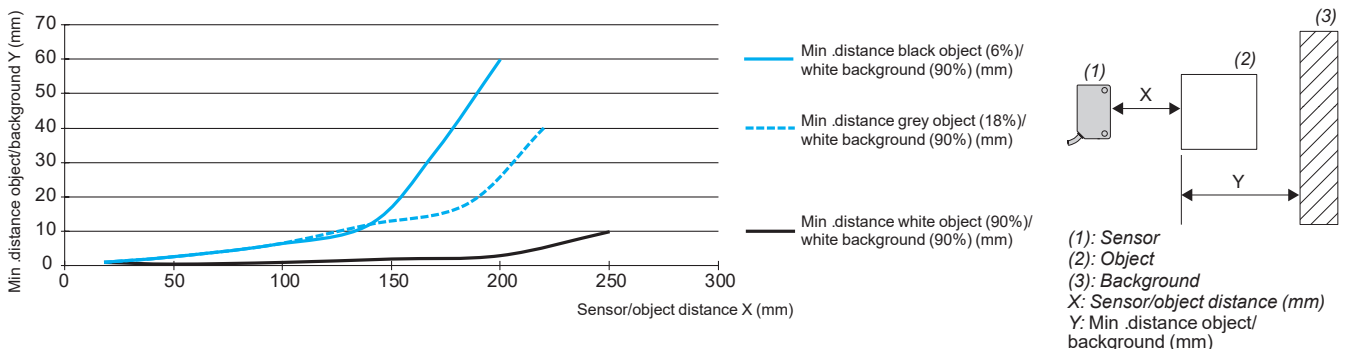

(1): Sensor
 (2): Object
 (3): Background
 X: Sensor/object distance (mm)
 Y: Min. distance object/background (mm)

Detection curves (continued)

Diffuse system: XUM4, XUM5 and XUM6

Object size/sensing distance

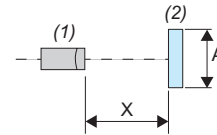
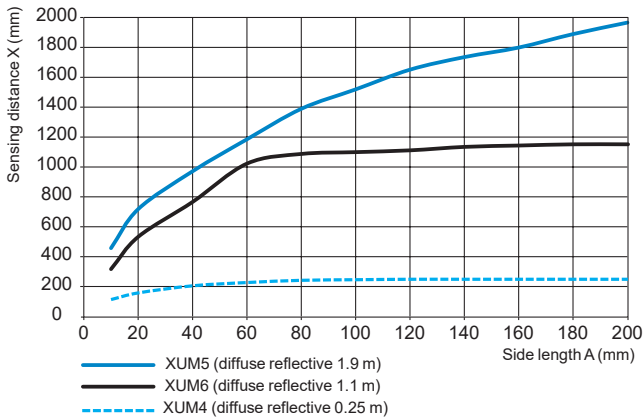

(1): Sensor
 (2): Object (white mat paper of A mm square)
 A: Side length (mm)
 X: Sensing distance (mm)

Lateral displacement

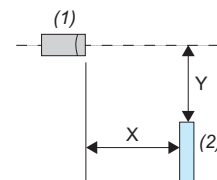
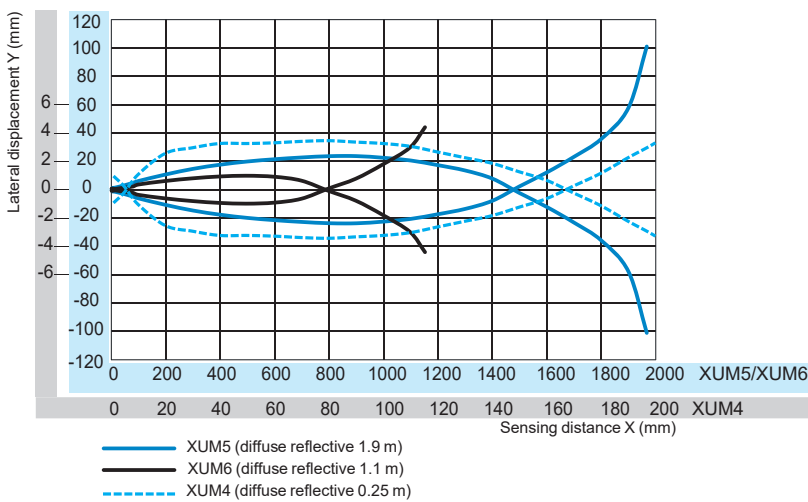

(1): Sensor
 (2): Object (200 x 200 mm square white paper)
 X: Sensing distance (mm)
 Y: Lateral displacement (mm)

Excess gain

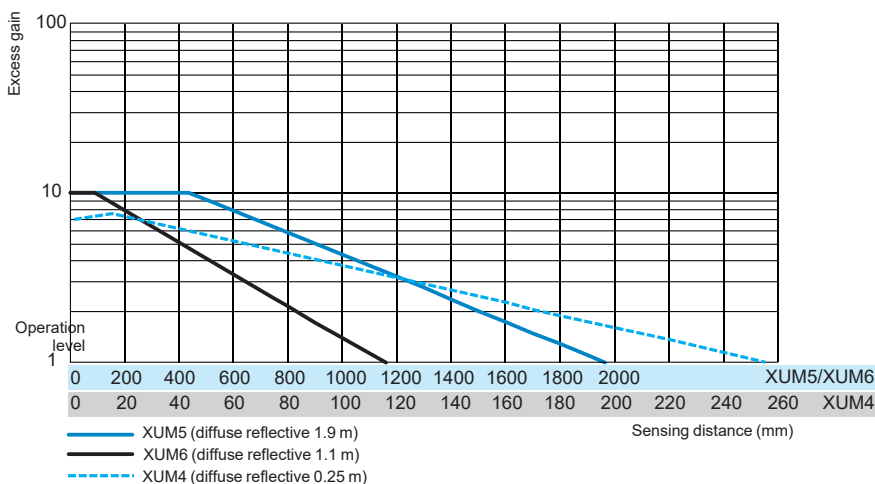

Photo-electric sensors

XUM, general purpose, single mode function

Miniature design, plastic

Three-wire DC, solid-state output

Thru-beam system

Pre-cabled and pigtail versions

Transmitter

Description - XUM2A●XBL2

Dimensions - XUM2A●XBL2

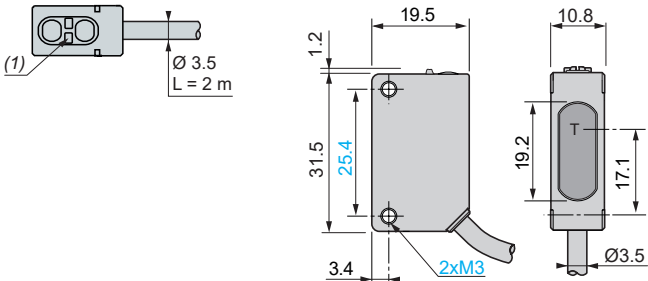

Receiver

Description - XUM2A●XBL2

Dimensions - XUM2A●XBL2

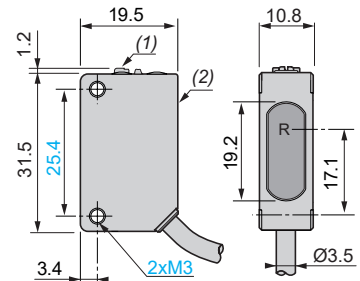

M8 connector version

Transmitter

Description - XUM2A●XBM8

Dimensions - XUM2A●XBM8

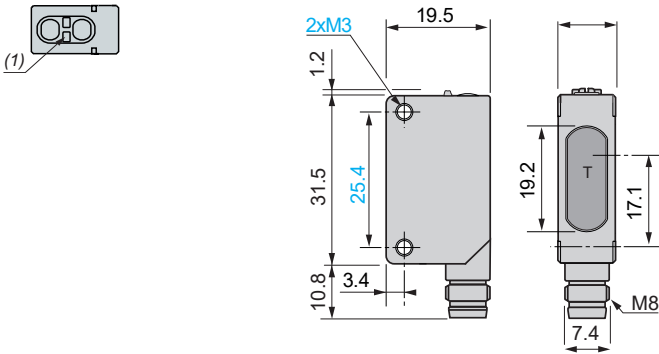

Receiver

Description - XUM2A●XBM8

Dimensions - XUM2A●XBM8

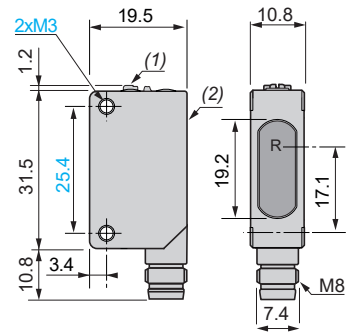

(1) Power ON indicator (green)

T: Transmission

(1) Output indicator (yellow)

(2) Setting potentiometer (sensitivity)

(3) Power ON indicator (green)

R: Reception

(1) Setting potentiometer (sensitivity)

(2) Setting potentiometer (output)

Polarised reflex system

Pre-cabled and pigtail versions

Description - XUM9A●XBL2

Dimensions - XUM9A●XBL2

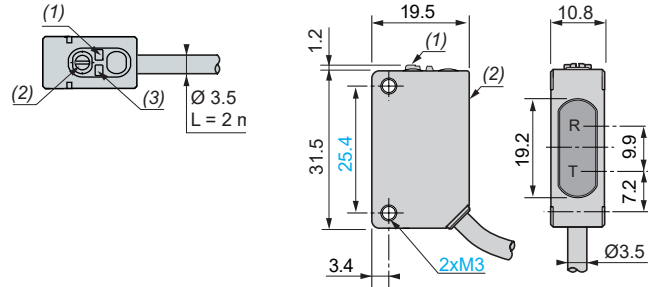

M8 connector version

Description - XUM9A●XBM8

Dimensions - XUM9A●XBM8

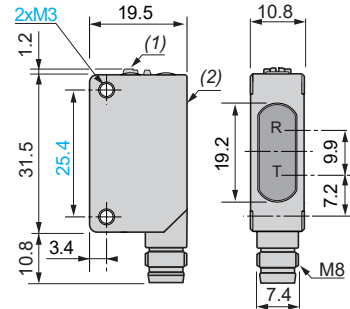

Background suppression system

Pre-cabled version

Description - XUM8A●XBL2

Dimensions - XUM8A●XBL2

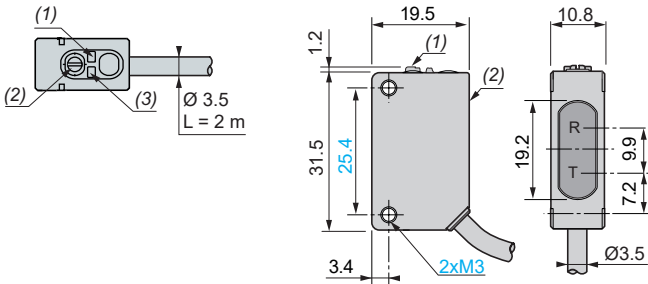

M8 connector version

Description - XUM8A●XBM8

Dimensions - XUM8A●XBM8

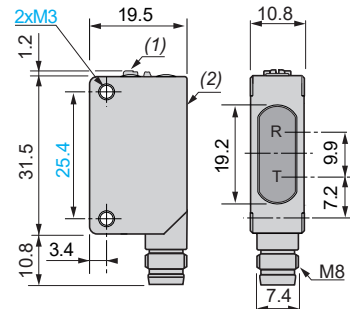

Photo-electric sensors

XUM, general purpose, single mode function

Miniature design, plastic

Three-wire DC, solid-state output

Diffuse system

Pre-cabled and pigtail versions

Description - XUM5A●XBL2,
XUM6A●XBL2, XUM4A●XBL2

Dimensions - XUM5A●XBL2,
XUM6A●XBL2, XUM4A●XBL2

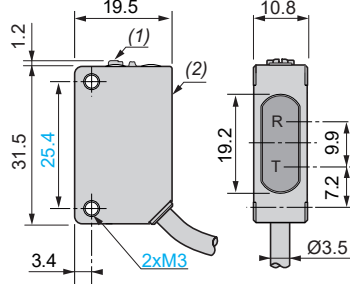
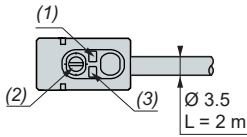

M8 connector version

Description - XUM5A●XBM8,
XUM6A●XBM8, XUM4A●XBM8

Dimensions - XUM5A●XBM8,
XUM6A●XBM8, XUM4A●XBM8

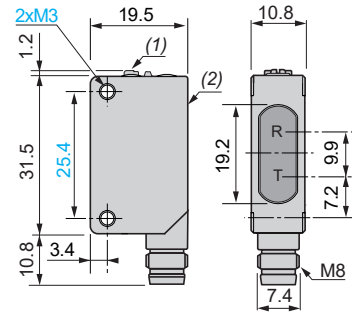
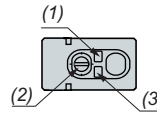

- (1) Output indicator (yellow)
- (2) Setting potentiometer (sensitivity)
- (3) Stability indicator (green)

- R: Reception
T: Transmission
(1) Setting potentiometer (sensitivity)
(2) Setting potentiometer (output)

- (1) Output indicator (yellow)
- (2) Setting potentiometer (sensitivity)
- (3) Stability indicator (green)

- R: Reception
T: Transmission
(1) Setting potentiometer (sensitivity)
(2) Setting potentiometer (output)

Accessories

Setting-up accessory

XUZASM05

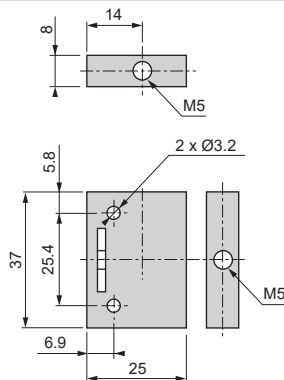

Diaphragms

XUZDVM●●

XUZDHM●●

XUZDRM●●

Reference a (mm)

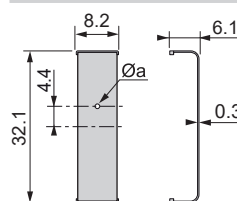
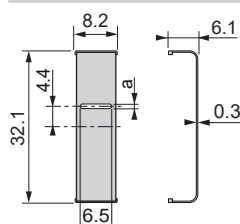
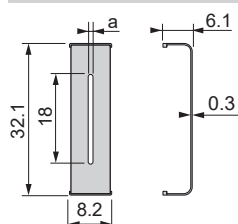

Reference	a (mm)
XUZDVM05	0.5
XUZDVM10	1
XUZDVM20	2
XUZDHM05	0.5
XUZDHM10	1
XUZDHM20	2
XUZDRM05	Ø 0.5
XUZDRM10	Ø 1
XUZDRM20	Ø 2

Photo-electric sensors

XUB general purpose, single mode function

Cylindrical miniature design 18, plastic

Four-wire DC, solid-state output

Wire setting for NO/NC



XUB2AKXNM12T



XUB2AKXWM12T



XUB2AKXNL2T



XUB2AKXWL2T



XUB2APXNM12R
XUB2ANXNM12R
XUB2APXNM12R



XUB2APXWM12R
XUB2ANXWM12R
XUB2APXWM12R



XUB2ANXNL2R
XUB2APXNL2R



XUB2ANXWL2R
XUB2APXWL2R

Thru-beam system with adjustable sensitivity

Max./operating sensing distance (Sn)/Line of sight	Function	Output	Connection	Reference	Weight kg
Transmitter (1)					
30 m/20 m Along case axis	–	–	Pre-cabled (L = 2 m)	XUB2AKXNL2T	0 095
			M12 connector (4-pin)	XUB2AKXNM12T	0 040
17 m/12 m 90° to case axis	–	–	Pre-cabled (L = 2 m)	XUB2AKXWL2T	0 095
			M12 connector (4-pin)	XUB2AKXWM12T	0 040

Receiver IO-Link

30 m/20 m Along case axis	NO (Dark ON)/ NC (Light ON) configuration by wire or IO-Link	Autodetect PNP/NPN	M12 connector (4-pin)	XUB2APYNM12R	0 040
			M12 connector (4-pin)	XUB2APYWM12R	0 040
17 m/12 m 90° to case axis	NO (Dark ON)/ NC (Light ON) configuration by wire or IO-Link	Autodetect PNP/NPN	M12 connector (4-pin)	XUB2APYNM12R	0 040
			M12 connector (4-pin)	XUB2APYWM12R	0 040

Receiver

30 m/20 m Along case axis	NO (Dark ON)/ NC (Light ON) configuration by wire	NPN	Pre-cabled (L = 2 m)	XUB2ANXNL2R	0 095
			M12 connector (4-pin)	XUB2ANXNM12R	0 040
		PNP	Pre-cabled (L = 2 m)	XUB2APXNL2R	0 095
			M12 connector (4-pin)	XUB2APXNM12R	0 040
17 m/12 m 90° to case axis	NO (Dark ON)/ NC (Light ON) configuration by wire	NPN	Pre-cabled (L = 2 m)	XUB2ANXWL2R	0 095
			M12 connector (4-pin)	XUB2ANXWM12R	0 040
		PNP	Pre-cabled (L = 2 m)	XUB2APXWL2R	0 095
			M12 connector (4-pin)	XUB2APXWM12R	0 040

Accessories

IO-Link Master (2)

See page 70 .

Fixing and other accessories

See page 74 .

Cabling accessories

See page 80 .

(1) All transmitters are compatible with the receivers listed below.

(2) Available 2nd quarter 2024.

Photo-electric sensors

XUB general purpose, single mode function

Cylindrical miniature design 18, metal

Four-wire DC, solid-state output

Wire setting for NO/NC



XUB2BKXNM12T



XUB2BKXWM12T



XUB2BKXNL2T



XUB2BKXWL2T



XUB2BPYNM12R
XUB2BNXNM12R
XUB2BPXNM12R



XUB2BPYWM12R
XUB2BNXWM12R
XUB2BPXWM12R



XUB2BNXNL2R
XUB2BPXNL2R



XUB2BNXWL2R
XUB2BPXWL2R

Thru-beam system with adjustable sensitivity

Max./operating sensing distance (Sn)/Line of sight	Function	Output	Connection	Reference	Weight kg
Transmitter (1)					
30 m/20 m Along case axis	–	–	Pre-cabled (L = 2 m)	XUB2BKXNL2T	0 095
			M12 connector (4-pin)	XUB2BKXNM12T	0 040
17 m/12 m 90° to case axis	–	–	Pre-cabled (L = 2 m)	XUB2BKXWL2T	0 095
			M12 connector (4-pin)	XUB2BKXWM12T	0 040

Receiver IO-Link

30 m/20 m Along case axis	NO (Dark ON)/ NC (Light ON) configuration by wire or IO-Link	Autodetect PNP/NPN	M12 connector (4-pin)	XUB2BPYNM12R	0 040
			M12 connector (4-pin)	XUB2BPYWM12R	0 040
17 m/12 m 90° to case axis	NO (Dark ON)/ NC (Light ON) configuration by wire or IO-Link	Autodetect PNP/NPN	M12 connector (4-pin)	XUB2BPYNM12R	0 040
			M12 connector (4-pin)	XUB2BPYWM12R	0 040

Receiver

30 m/20 m Along case axis	NO (Dark ON)/ NC (Light ON) configuration by wire	NPN	Pre-cabled (L = 2 m)	XUB2BNXNL2R	0 095
			M12 connector (4-pin)	XUB2BNXNM12R	0 040
		PNP	Pre-cabled (L = 2 m)	XUB2BPXNL2R	0 095
			M12 connector (4-pin)	XUB2BPXNM12R	0 040
17 m/12 m 90° to case axis	NO (Dark ON)/ NC (Light ON) configuration by wire	NPN	Pre-cabled (L = 2 m)	XUB2BNXWL2R	0 095
			M12 connector (4-pin)	XUB2BNXWM12R	0 040
		PNP	Pre-cabled (L = 2 m)	XUB2BPXWL2R	0 095
			M12 connector (4-pin)	XUB2BPXWM12R	0 040

Accessories

IO-Link Master (2)

See page 70 .

Fixing and other accessories

See page 74 .

Cabling accessories

See page 80 .

(1) All transmitters are compatible with the receivers listed below.

(2) Available 2nd quarter 2024.

Photo-electric sensors

XUB general purpose, single mode function

Cylindrical miniature design 18, plastic

Four-wire DC, solid-state output

Wire setting for NO/NC

Apelec_CP0720004



XUB●APYNM12
XUB●ANXNM12
XUB●APXNM12

Apelec_CP0720008



XUB●APYWM12
XUB●ANXWM12
XUB●APXWM12

Apelec_CP0720002



XUB●ANXNL2
XUB●APXNL2

Apelec_CP0720006



XUB●ANXWL2
XUB●APXWL2

Diffuse system with adjustable sensitivity, IO-Link

Max./operating sensing distance (Sn)/Line of sight	Function	Output	Connection	Reference	Weight kg
--	----------	--------	------------	-----------	-----------

Long range, red LED emission

1 m/0.7 m Along case axis	NO (Light ON)/ NC (Dark ON) configuration by wire or IO-Link	Autodetect PNP/NPN	M12 connector (4-pin)	XUB5APYNM12	0 040
------------------------------	---	-----------------------	--------------------------	--------------------	-------

Medium range, red LED emission

0.6 m/0.42 m Along case axis	NO (Light ON)/ NC (Dark ON) configuration by wire or IO-Link	Autodetect PNP/NPN	M12 connector (4-pin)	XUB6APYNM12	0 040
0.5 m/0.35 m 90° to case axis	NO (Light ON)/ NC (Dark ON) configuration by wire or IO-Link	Autodetect PNP/NPN	M12 connector (4-pin)	XUB6APYWM12	0 040

Diffuse system with adjustable sensitivity

Max./operating sensing distance (Sn)/Line of sight	Function	Output	Connection	Reference	Weight kg
--	----------	--------	------------	-----------	-----------

Long range, red LED emission

1 m/0.7 m Along case axis	NO (Light ON)/ NC (Dark ON) configuration by wire	NPN	Pre-cabled (L = 2 m)	XUB5ANXNL2	0 095
			M12 connector (4-pin)	XUB5ANXNM12	0 040
		PNP	Pre-cabled (L = 2 m)	XUB5APXNL2	0 095
			M12 connector (4-pin)	XUB5APXNM12	0 040

Medium range, red LED emission

0.6 m/0.42 m Along case axis	NO (Light ON)/ NC (Dark ON) configuration by wire	NPN	Pre-cabled (L = 2 m)	XUB6ANXNL2	0 095
			M12 connector (4-pin)	XUB6ANXNM12	0 040
		PNP	Pre-cabled (L = 2 m)	XUB6APXNL2	0 095
			M12 connector (4-pin)	XUB6APXNM12	0 040
0.5 m/0.35 m 90° to case axis	NO (Light ON)/ NC (Dark ON) configuration by wire	NPN	Pre-cabled (L = 2 m)	XUB6ANXWL2	0 095
			M12 connector (4-pin)	XUB6ANXWM12	0 040
		PNP	Pre-cabled (L = 2 m)	XUB6APXWL2	0 095
			M12 connector (4-pin)	XUB6APXWM12	0 040

Accessories

IO-Link Master (1)

See page 70 .

Fixing and other accessories

See page 74 .

Cabling accessories

See page 80 .

(1) Available 2nd quarter 2024.

Photo-electric sensors

XUB general purpose, single mode function

Cylindrical miniature design 18, metal

Four-wire DC, solid-state output

Wire setting for NO/NC



XUB6BPYNM12
XUB6BNXNM12
XUB6BPXNM12



XUB6BPYWM12
XUB6BNXWM12
XUB6BPXWM12



XUB6BNXNL2
XUB6BPXNL2



XUB6BNXWL2
XUB6BPXWL2

Diffuse system with adjustable sensitivity, IO-Link

Max./operating sensing distance (Sn)/Line of sight	Function	Output	Connection	Reference	Weight kg
Long range, red LED emission					
1 m/0.7 m Along case axis	NO (Light ON)/ NC (Dark ON) configuration by wire or IO-Link	Autodetect	M12 connector (4-pin)	XUB5BPYNM12	0 040
		PNP/NPN			
Medium range, red LED emission					
0.6 m/0.42 m Along case axis	NO (Light ON)/ NC (Dark ON) configuration by wire or IO-Link	Autodetect	M12 connector (4-pin)	XUB6BPYNM12	0 040
		PNP/NPN			
0.5 m/0.35 m 90° to case axis	NO (Light ON)/ NC (Dark ON) configuration by wire or IO-Link	Autodetect	M12 connector (4-pin)	XUB6BPYWM12	0 040
		PNP/NPN			

Diffuse system with adjustable sensitivity

Max./operating sensing distance (Sn)/Line of sight	Function	Output	Connection	Reference	Weight kg		
Long range, red LED emission							
1 m/0.7 m Along case axis	NO (Light ON)/ NC (Dark ON) configuration by wire	NPN	Pre-cabled (L = 2 m)	XUB5BNXNL2	0 095		
			M12 connector (4-pin)	XUB5BNXNM12	0 040		
		PNP	Pre-cabled (L = 2 m)	XUB5BPXNL2	0 095		
			M12 connector (4-pin)	XUB5BPXNM12	0 040		
		Medium range, red LED emission					
		0.6 m/0.42 m Along case axis	NO (Light ON)/ NC (Dark ON) configuration by wire	NPN	Pre-cabled (L = 2 m)	XUB6BNXNL2	0 095
M12 connector (4-pin)	XUB6BNXNM12				0 040		
PNP	Pre-cabled (L = 2 m)			XUB6BPXNL2	0 095		
	M12 connector (4-pin)			XUB6BPXNM12	0 040		
0.5 m/0.35 m 90° to case axis	NO (Light ON)/ NC (Dark ON) configuration by wire			NPN	Pre-cabled (L = 2 m)	XUB6BNXWL2	0 095
					M12 connector (4-pin)	XUB6BNXWM12	0 040
		PNP	Pre-cabled (L = 2 m)	XUB6BPXWL2	0 095		
			M12 connector (4-pin)	XUB6BPXWM12	0 040		

Accessories

IO-Link Master (1)

See page 70 .

Fixing and other accessories

See page 74 .

Cabling accessories

See page 80 .

(1) Available 2nd quarter 2024.

Photo-electric sensors

XUB general purpose, single mode function

Cylindrical miniature design 18, plastic

Four-wire DC, solid-state output

Wire setting for NO/NC



XUB9APYNM12
XUB9ANXNM12
XUB9APXNM12



XUB9APYWM12
XUB9ANXWM12
XUB9APXWM12



XUB9ANXNL2
XUB9APXNL2



XUB9ANXWL2
XUB9APXWL2

Polarised reflex system with adjustable sensitivity, IO-Link

Plastic, red LED emission

Max./operating sensing distance (Sn)/Line of sight	Function	Output	Connection	Reference	Weight kg
7 m/5 m Along case axis	NO (Dark ON)/ NC (Light ON) configuration by wire or IO-Link	Autodetect PNP/NPN	M12 connector (4-pin)	XUB9APYNM12	0 040
5.5 m/4 m 90° to case axis	NO (Dark ON)/ NC (Light ON) configuration by wire or IO-Link	Autodetect PNP/NPN	M12 connector (4-pin)	XUB9APYWM12	0 040

Polarised reflex system with adjustable sensitivity

Plastic, red LED emission

Max./operating sensing distance (Sn)/Line of sight	Function	Output	Connection	Reference	Weight kg		
7 m/5 m Along case axis	NO (Dark ON)/ NC (Light ON) configuration by wire	NPN	Pre-cabled (L = 2 m)	XUB9ANXNL2	0 095		
			M12 connector (4-pin)	XUB9ANXNM12	0 040		
		PNP	Pre-cabled (L = 2 m)	XUB9APXNL2	0 095		
			M12 connector (4-pin)	XUB9APXNM12	0 040		
		5.5 m/4 m 90° to case axis	NO (Dark ON)/ NC (Light ON) configuration by wire	NPN	Pre-cabled (L = 2 m)	XUB9ANXWL2	0 095
					M12 connector (4-pin)	XUB9ANXWM12	0 040
PNP	Pre-cabled (L = 2 m)	XUB9APXWL2	0 095				
		M12 connector (4-pin)	XUB9APXWM12	0 040			

Accessories

IO-Link Master (1)

See page 70 .

Fixing and other accessories

See page 74 .

Cabling accessories

See page 80 .

(1) Available 2nd quarter 2024.

Photo-electric sensors

XUB general purpose, single mode function

Cylindrical miniature design 18, metal

Four-wire DC, solid-state output

Wire setting for NO/NC



XUB9BPYNM12
XUB9BNXNM12
XUB9BPXNM12



XUB9BPYWM12
XUB9BNXWM12
XUB9BPXWM12



XUB9BNXNL2
XUB9BPXNL2



XUB9BNXWL2
XUB9BPXWL2

Polarised reflex system with adjustable sensitivity, IO-Link

Metal, red LED emission

Max./operating sensing distance (Sn)/Line of sight	Function	Output	Connection	Reference	Weight kg
7 m/5 m Along case axis	NO (Dark ON)/ NC (Light ON) configuration by wire or IO-Link	Autodetect PNP/NPN	M12 connector (4-pin)	XUB9BPYNM12	0 040
5.5 m/4 m 90° to case axis	NO (Dark ON)/ NC (Light ON) configuration by wire or IO-Link	Autodetect PNP/NPN	M12 connector (4-pin)	XUB9BPYWM12	0 040

Polarised reflex system with adjustable sensitivity

Max./operating sensing distance (Sn)/Line of sight	Function	Output	Connection	Reference	Weight kg
Metal, red LED emission					
7 m/5 m Along case axis	NO (Dark ON)/ NC (Light ON) configuration by wire	NPN	Pre-cabled (L = 2 m)	XUB9BNXNL2	0 095
			M12 connector (4-pin)	XUB9BNXNM12	0 040
5.5 m/4 m 90° to case axis	NO (Dark ON)/ NC (Light ON) configuration by wire	PNP	Pre-cabled (L = 2 m)	XUB9BPXNL2	0 095
			M12 connector (4-pin)	XUB9BPXNM12	0 040
		NPN	Pre-cabled (L = 2 m)	XUB9BNXWL2	0 095
			M12 connector (4-pin)	XUB9BNXWM12	0 040
5.5 m/4 m 90° to case axis	NO (Dark ON)/ NC (Light ON) configuration by wire	PNP	Pre-cabled (L = 2 m)	XUB9BPXWL2	0 095
			M12 connector (4-pin)	XUB9BPXWM12	0 040

Accessories

IO-Link Master (1)

See page 70 .

Fixing and other accessories

See page 74 .

Cabling accessories

See page 80 .

(1) Available 2nd quarter 2024.

Photo-electric sensors

XUB general purpose, single mode function

Cylindrical miniature design 18, plastic

Four-wire DC, solid-state output

Wire setting for NO/NC

Characteristics			
Sensor type		XUB2APY●M12R, XUB2BPY●M12R, XUB2A●X●M12T, XUB2A●X●M12R, XUB2B●X●M12T, XUB2B●X●M12R, XUB5APYNM12, XUB5BPYNM12, XUB5A●X●M12, XUB5B●X●M12, XUB6APY●M12, XUB6APY●M12, XUB6A●X●M12, XUB6B●X●M12, XUB9APY●M12, XUB9BPY●M12, XUB9A●X●M12, XUB9B●X●M12	
Product certifications		CE, UKCA, cULus	
Connection	Connector	M12	
	Pre-cabled	–	
Sensing distance Excess gain = 1 : maximum sensing distance Excess gain = 2 : nominal sensing distance	Thru-beam system XUB2	Along case axis (axial)	m 30 (with excess gain = 1) 20 (with excess gain = 2)
		90° to case axis (radial)	m 17 (with excess gain = 1) 12 (with excess gain = 2)
	Diffuse system XUB5 (using a white paper 200 x 200 mm)	Along case axis (axial)	m 1 (with excess gain = 1) 0.7 (with excess gain = 2)
		Diffuse system XUB6 (using a white paper 200 x 200 mm)	Along case axis (axial)
	90° to case axis (radial)		m 0.5 (with excess gain = 1) 0.35 (with excess gain = 2)
	Polarised reflex system XUB9 (using a 50 x 50 mm reflector XUZC50)	Along case axis	m 7 (with excess gain = 1) 5 (with excess gain = 2)
90° to case axis		m 5.5 (with excess gain = 1) 4 (with excess gain = 2)	
Blind zone		mm 0 (white object and potentiometer max.)	
Sensing distance setting		Potentiometer 1 turn (+/- 220 degrees)	
Colour of detection light beam		Red (except XUB2 transmitter)	
Output type		PNP/NPN (or autodetect PNP/NPN with IO-Link)	
Hysteresis		2% < H < 20% at Sn	
Degree of protection	Conforming to IEC 60529	IP65, IP67	
	Conforming to DIN 40050-9	IP69K (M12 connector versions only)	
Artificial optical radiation	Conforming to IEC 62471	Class 0 (risk exempt)	
Radiated disturbances emissions	Conforming to EN 55011/CISPR 1	Class A	
Storage temperature		°C -40...+70	
Operating temperature		°C -30...+55	
Materials	Case	XUB2A, XUB5A, XUB6A and XUB9A: PBT/PC XUB2B, XUB5B, XUB6B and XUB9B: brass	
	Back cap	MABS	
	Potentiometer screw	PBT	
	Lens cover	PMMA	
	Cable	–	PVC
Vibration resistance	Conforming to IEC 60068-2-6	Frequency range: 10 to 55 Hz Acceleration: 7 gn	
Shock resistance	Conforming to IEC 60068-2-27	Peak acceleration: 30 gn Duration of the pulse: 11 ms	
Rated supply voltage		V 12 . 24 --- with protection against reverse polarity	
Voltage limits (including ripple)		V 10 . 30 ---	
Current consumption, no-load		mA < 20/IO-Link: < 30	
Switching capacity		mA 100	
Voltage drop, closed state		V ≤ 2	
Maximum switching frequency		Hz 1000	
Delays	First-up	ms < 100/IO-Link : < 300	
	Response	ms 0.5 max.	
	Recovery	ms 0.5 max	

Photo-electric sensors

XUB general purpose, single mode function

Cylindrical miniature design 18

Four-wire DC, solid-state output

Wire setting for NO/NC

Wiring schemes

Thru-beam system

M12 connector - 4 pins, plastic and metal, IO-Link

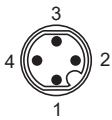

Pin	Signal	Definition
1	+	+ 24 V $\overline{\text{DC}}$
2	IN	+ = NO - = NC Open = NO
3	-	0 V $\overline{\text{DC}}$
4	Q	Switching signal (SIO)
	C	IO-Link communication

Autodetect PNP/NPN or by IO-Link

XUB2•PYNM12R, XUB2•PYWM12R, XUB2•KXNM12T, XUB2•KXWM12T

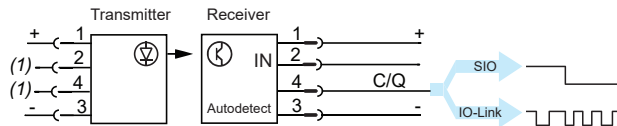

Note: IO-Link files available on our website www.telemecanique.com/iolink

M12 connector - 4 pins, plastic and metal

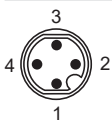

Pin	Signal	Definition
1	+	+ 24 V $\overline{\text{DC}}$
2	IN	+ = NO - = NC Open = NO
3	-	0 V $\overline{\text{DC}}$
4	Q	Switching signal (SIO)

PNP

XUB2•PXNM12R, XUB2•PXWM12R,
XUB2•KXNM12T, XUB2•KXWM12T

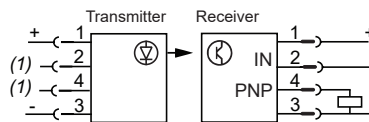

NPN

XUB2•NXNM12R, XUB2•NXWM12R,
XUB2•KXNM12T, XUB2•KXWM12T

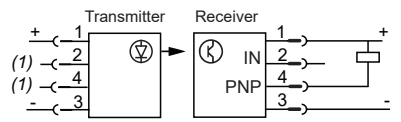

Pre-cabled - 4 wires, plastic and metal

+BN (Brown)
IN (input) GY (Grey)
OUT (output) BK (Black)
-BU (Blue)

PNP

XUB2•PXNL2R, XUB2•APXWL2R,
XUB2•KXNL2T, XUB2•KXWL2T

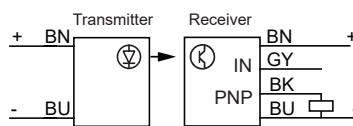

NPN

XUB2•NXNL2R, XUB2•NXWL2R,
XUB2•KXNL2T, XUB2•KXWL2T

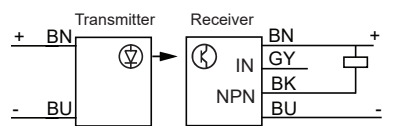

Diffuse system

M12 connector - 4 pins, plastic and metal, IO-Link

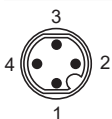

Pin	Signal	Definition
1	+	+ 24 V $\overline{\text{DC}}$
2	IN	+ = NO - = NC Open = NO
3	-	0 V $\overline{\text{DC}}$
4	Q	Switching signal (SIO)
	C	IO-Link communication

Autodetect PNP/NPN or by IO-Link

XUB5APYNM12, XUB6APYNM12, XUB6APYWM12, XUB5BPYNM12, XUB6BPYNM12,
XUB6BPYWM12

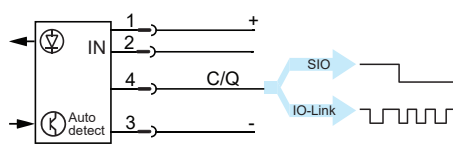

Note: IO-Link files available on our website www.telemecanique.com/iolink

M12 connector - 4 pins, plastic and metal

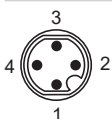

Pin	Signal	Definition
1	+	+ 24 V $\overline{\text{DC}}$
2	IN	+ = NO - = NC Open = NO
3	-	0 V $\overline{\text{DC}}$
4	Q	Switching signal (SIO)

PNP

XUB5APXNM12, XUB6APXNM12,
XUB6APXWM12, XUB5BPXNM12,
XUB6BPXNM12, XUB6BPXWM12,

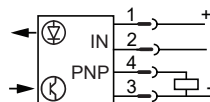

NPN

XUB5ANXNM12, XUB6ANXNM12,
XUB6ANXWM12, XUB5BNXNM12,
XUB6BNXNM12, XUB6BNXWM12

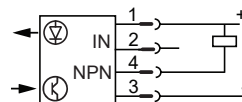

Pre-cabled - 4 wires, plastic and metal

+BN (Brown)
IN (input) GY (Grey)
OUT (output) BK (Black)
-BU (Blue)

PNP

XUB5APXNL2, XUB6APXNL2, XUB6APXWL2,
XUB5BPXNL2, XUB6BPXNL2, XUB6BPXWL2

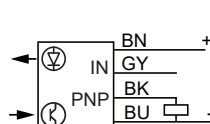

NPN

XUB5ANXNL2, XUB6ANXNL2,
XUB6ANXWL2, XUB5BNXNL2,
XUB6BNXNL2, XUB6BNXWL2

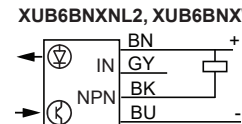

(1) Not connected.

Photo-electric sensors

XUB general purpose, single mode function

Cylindrical miniature design 18

Four-wire DC, solid-state output

Wire setting for NO/NC

Wiring schemes (continued)

Polarised reflex system

M12 connector - 4 pins, plastic and metal, IO-Link

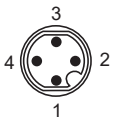

Pin	Signal	Definition
1	+	+ 24 V $\overline{\text{---}}$
2	IN	+ = NO - = NC Open = NO
3	-	0 V $\overline{\text{---}}$
4	Q	Switching signal (SIO)
	C	IO-Link communication

Autodetect PNP/NPN or by IO-Link

XUB9APYNM12, XUB9APYW12, XUB9BPYNM12, XUB9BPYW12

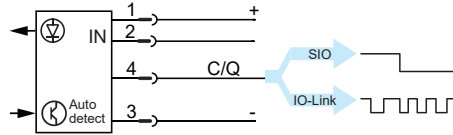

Note: IODD IO-Link files available on our website www.telemecanique-sensors.com/iolink

M12 connector - 4 pins, plastic and metal

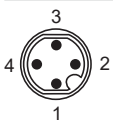

Pin	Signal	Definition
1	+	+ 24 V $\overline{\text{---}}$
2	IN	+ = NO - = NC Open = NO
3	-	0 V $\overline{\text{---}}$
4	Q	Switching signal (SIO)

PNP

XUB9APXNM12, XUB9APXW12,
XUB9BPXNM12, XUB9BPXW12

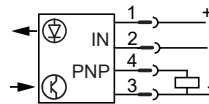

NPN

XUB9ANXNM12, XUB9ANXW12,
XUB9BNXNM12, XUB9BNXW12

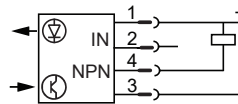

Pre-cabled - 4 wires, plastic and metal

+BN (Brown)
IN (input) GY (Grey)
OUT (output) BK (Black)
-BU (Blue)

PNP

XUB9APXNL2, XUB9BAPXWL2,
XUB9BPXNL2, XUB9BPXWL2

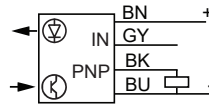

NPN

XUB9ANXNL2, XUB9ANXWL2,
XUB9BNXNL2, XUB9BNXWL2

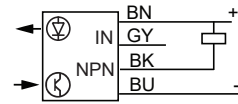

Photo-electric sensors

XUB general purpose, single mode function

Cylindrical miniature design 18

Four-wire DC, solid-state output

Wire setting for NO/NC

Detection curves

Thru-beam system: XUB2

Lateral displacement

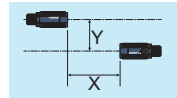
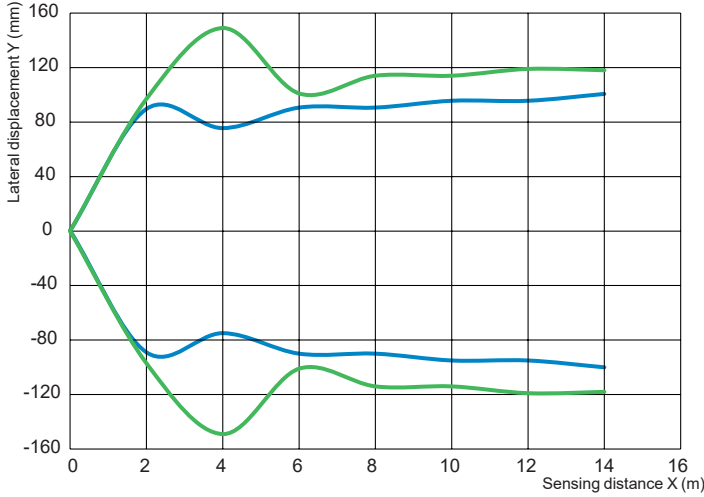

— Line of sight: along case axis (axial)

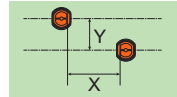

— Line of sight: 90° to case axis (radial)

Light beam diameter

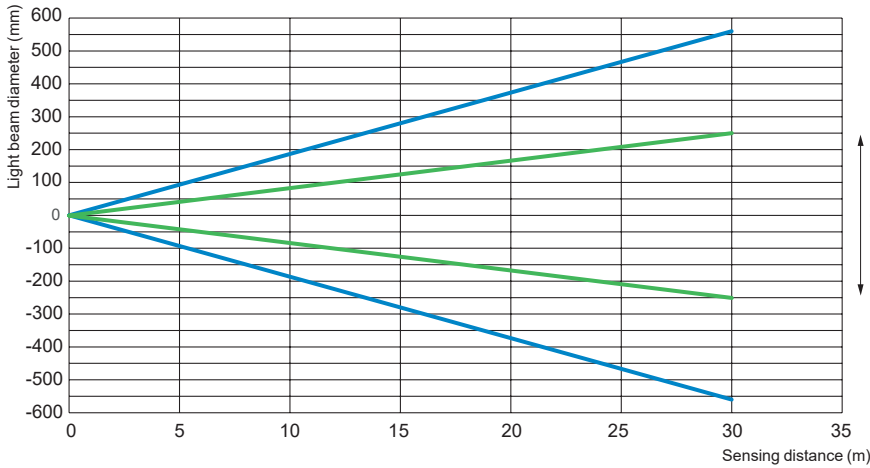

∅ Spot diameter

— Line of sight: 90° to case axis (radial)

— Line of sight: along case axis (axial)

Excess gain

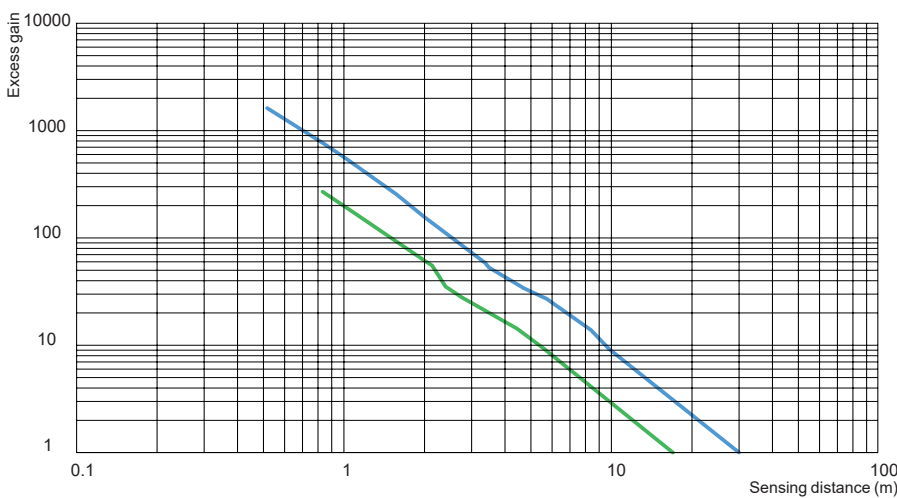

— Line of sight: 90° to case axis (radial)

— Line of sight: Along case axis (axial)

Photo-electric sensors

XUB general purpose, single mode function

Cylindrical miniature design 18

Four-wire DC, solid-state output

Wire setting for NO/NC

Detection curves (continued)

Diffuse system: XUB5 and XUB6

Minimum object size/sensing distance. Line of sight: along case axis (axial)

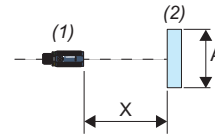
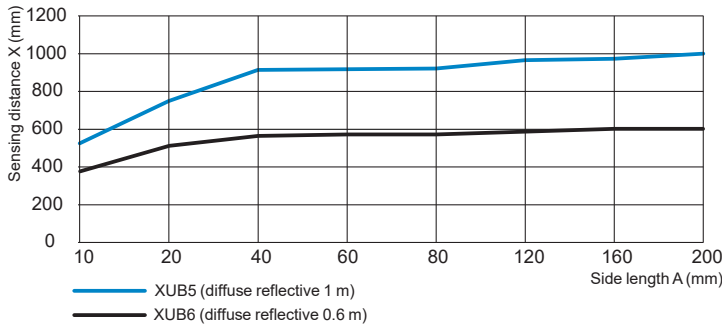

- (1): Sensor
- (2): Object (white matt paper of A mm square)
- A: Side length (mm)
- X: Sensing distance (mm)

Minimum object size/sensing distance. Line of sight: 90° to case axis (radial)

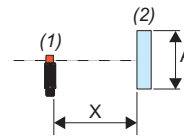
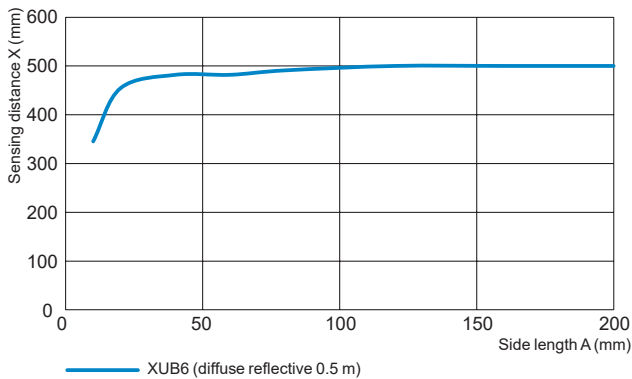

- (1): Sensor
- (2): Object (white matt paper of A mm square)
- A: Side length (mm)
- X: Sensing distance (mm)

Lateral displacement. Line of sight: along case axis (axial)

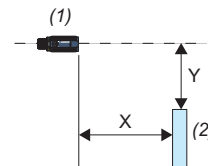
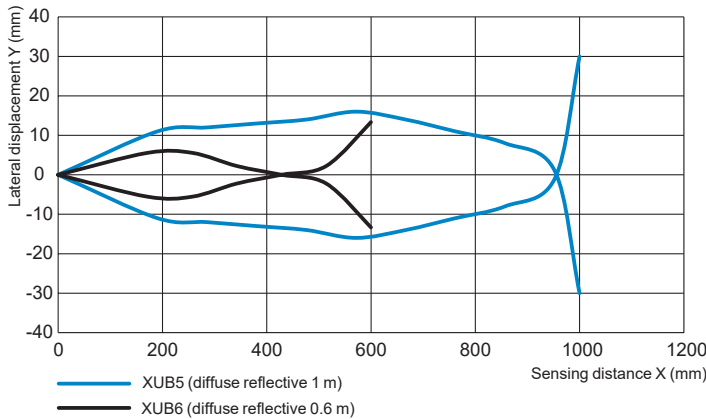

- (1): Sensor
- (2): Object (200 mm square white paper)
- X: Sensing distance (mm)
- Y: Lateral displacement (mm)

Lateral displacement. Line of sight: 90° to case axis (radial)

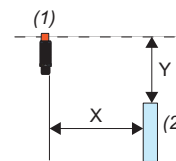
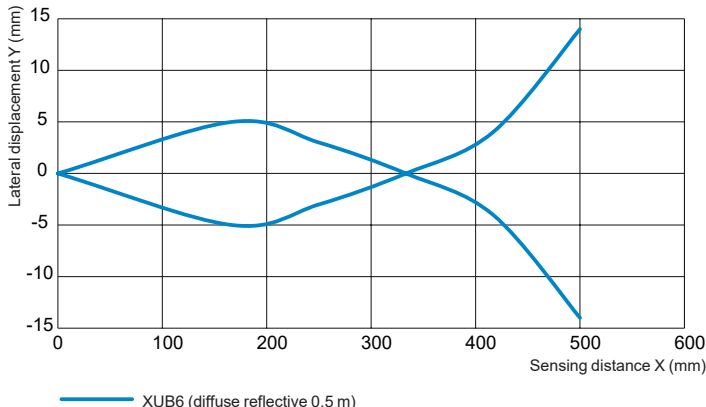

- (1): Sensor
- (2): Object (200 mm square white paper)
- X: Sensing distance (mm)
- Y: Lateral displacement (mm)

Photo-electric sensors

XUB general purpose, single mode function

Cylindrical miniature design 18

Four-wire DC, solid-state output

Wire setting for NO/NC

Detection curves (continued)

Diffuse system: XUB5 and XUB6 (continued)

Excess gain. Line of sight: along case axis (axial)

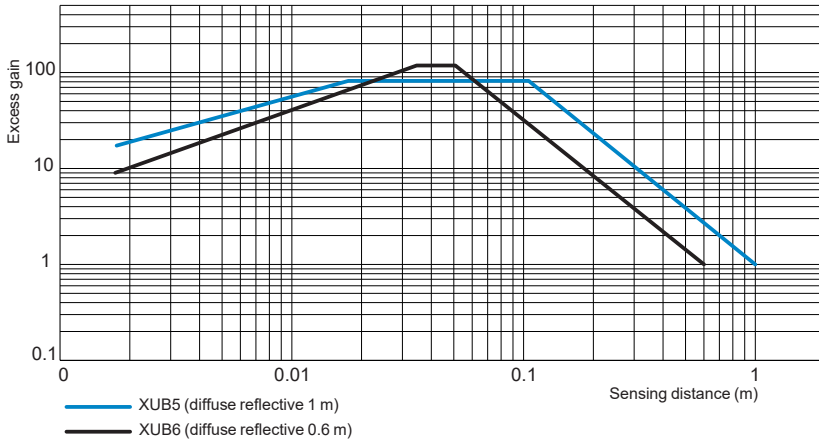

Excess gain. Line of sight: 90° to case axis (radial)

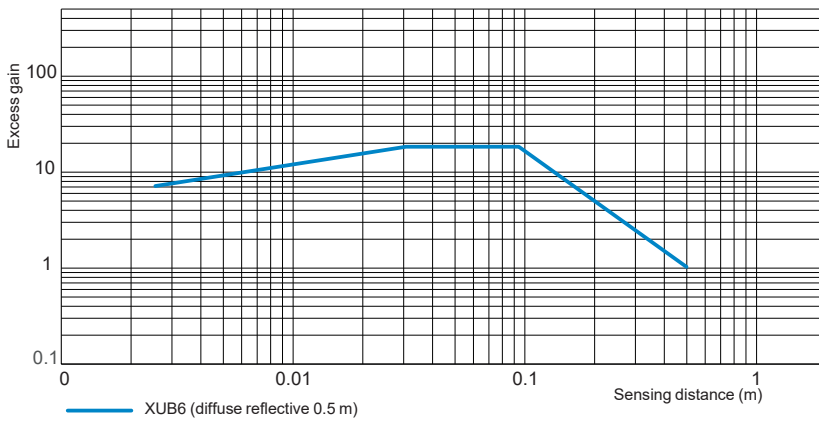

Polarised reflex system: XUB9

Reflector angle. Line of sight: along case axis (axial)

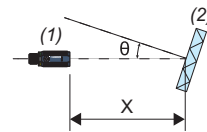
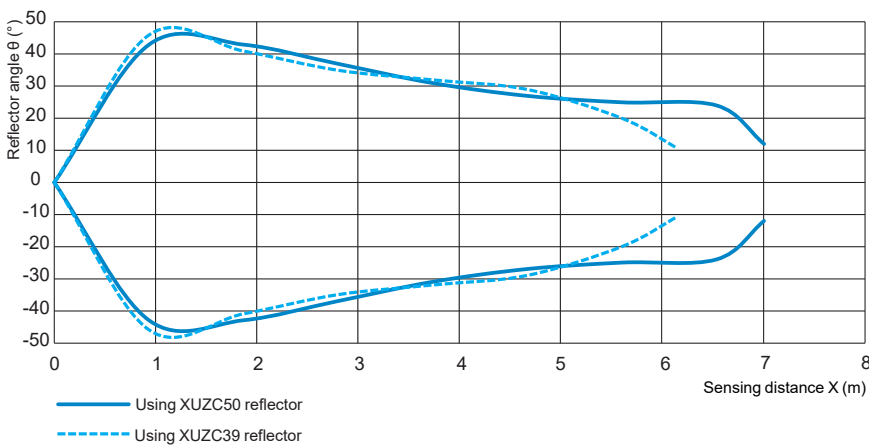

(1): Sensor
 (2): Reflector
 θ : Reflector angle (°)
 X: Sensing distance (m)

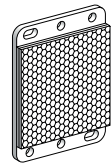

XUZC50



XUZC39

Photo-electric sensors

XUB general purpose, single mode function

Cylindrical miniature design 18

Four-wire DC, solid-state output

Wire setting for NO/NC

Detection curves (continued)

Polarised reflex system: XUB9 (continued)

Reflector angle. Line of sight: 90° to case axis (radial)

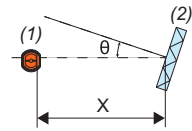
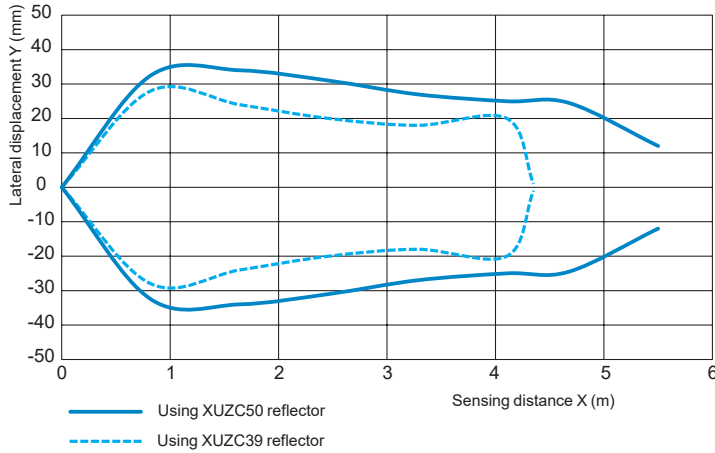

(1): Sensor
(2): Reflector
 θ : Reflector angle (°)
X: Sensing distance (m)

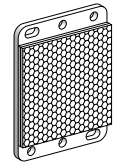

XUZC50



XUZC39

Lateral displacement. Line of sight: along case axis (axial)

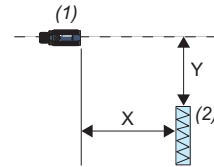
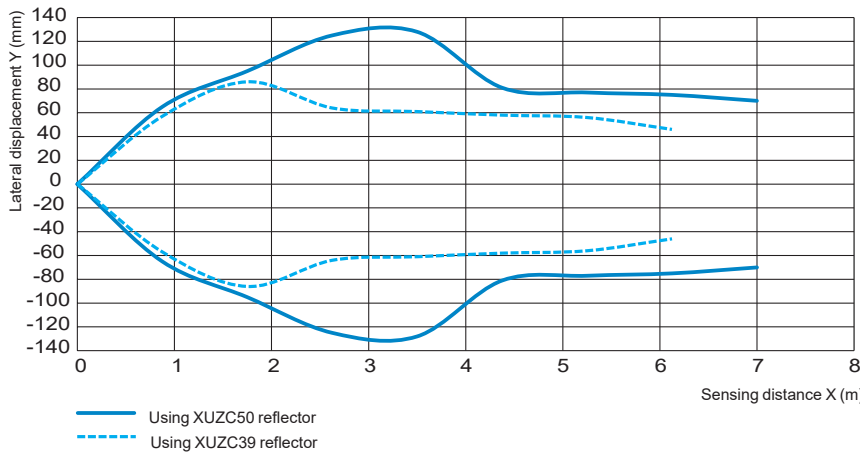

(1): Sensor
(2): Reflector
Y: Lateral displacement (mm)
X: Sensing distance (m)

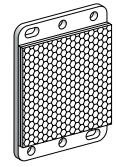

XUZC50



XUZC39

Lateral displacement. Line of sight: along case axis (axial)

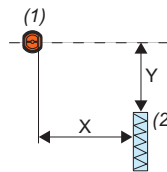
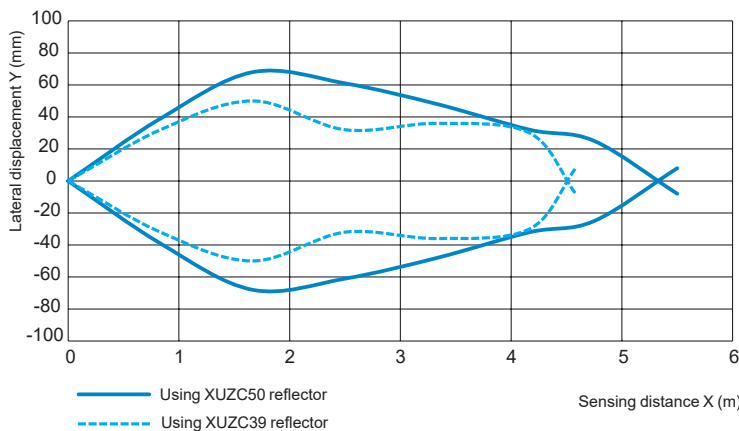

(1): Sensor
(2): Reflector
Y: Lateral displacement (mm)
X: Sensing distance (m)

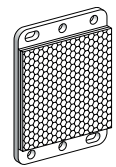

XUZC50



XUZC39

Photo-electric sensors

XUB general purpose, single mode function

Cylindrical miniature design 18, plastic

Four-wire DC, solid-state output

Wire setting for NO/NC

Detection curves (continued)

Polarised reflex system: XUB9 (continued)

Excess gain

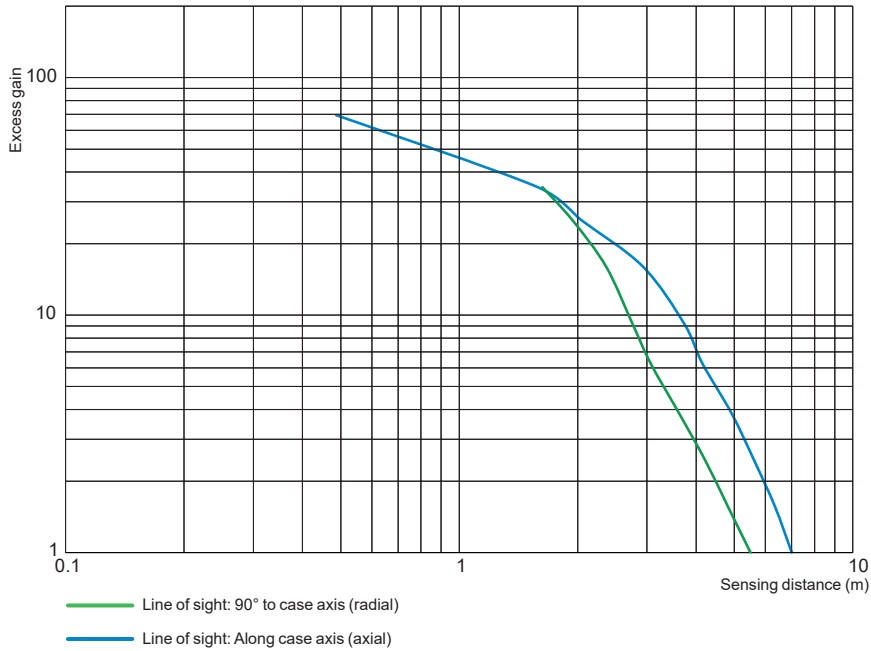

Photo-electric sensors

XUB general purpose, single mode function

Cylindrical miniature design 18, plastic

Four-wire DC, solid-state output

Wire setting for NO/NC

Thru-beam system, plastic, M12 connector version

Line of sight: along case axis (axial)

Transmitter

XUB2AKXNM12T

Receiver

XUB2APYNM12R, XUB2ANXNM12R, XUB2APXNM12R

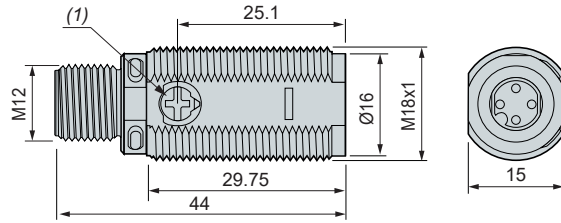
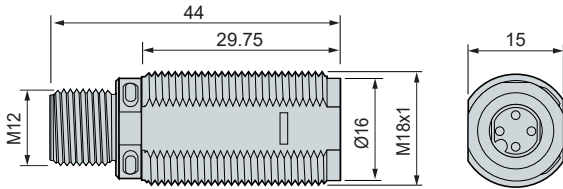

Line of sight: 90° to case axis (radial)

Transmitter

XUB2AKXWM12T

Receiver

XUB2APYW12R, XUB2ANXWM12R, XUB2APXWM12R

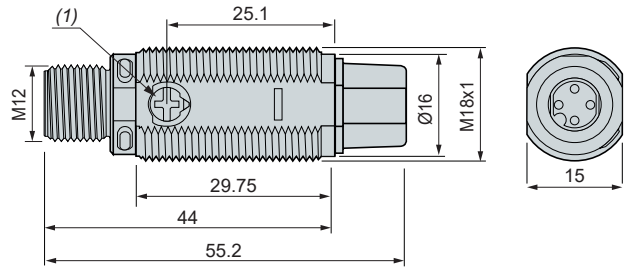
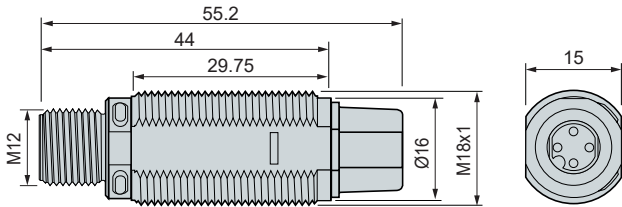

Thru-beam system, plastic, pre-cabled version

Line of sight: along case axis (axial)

Transmitter

XUB2AKXNL2T

Receiver

XUB2ANXNL2R, XUB2APXNL2R

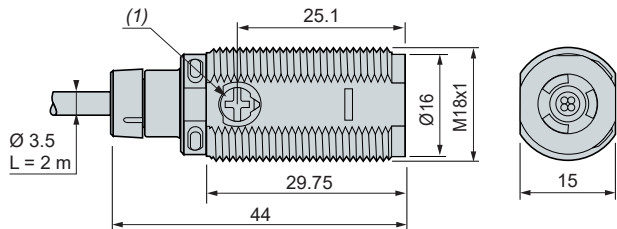
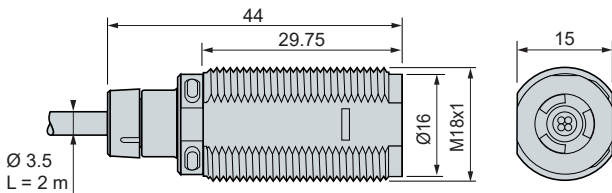

Pre-cabled version, line of sight 90° to case axis

Transmitter

XUB2AKXWL2T

Receiver

XUB2ANXWL2R, XUB2APXWL2R

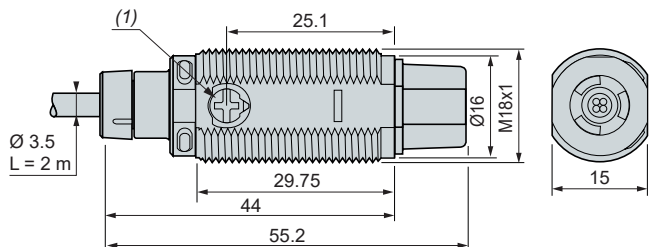
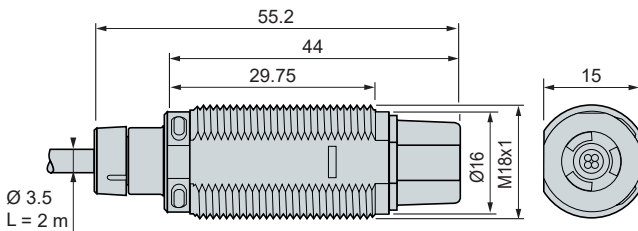

(1) Adjustment potentiometer (sensitivity).

Photo-electric sensors

XUB general purpose, single mode function

Cylindrical miniature design 18, metal

Four-wire DC, solid-state output

Wire setting for NO/NC

Thru-beam system, metal, M12 connector version

Line of sight: along case axis (axial)

Transmitter

XUB2BKXNM12T

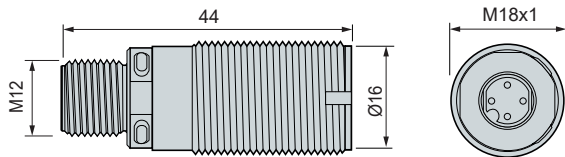

Receiver

XUB2BPYNM12R, XUB2BNXNM12R, XUB2BPXNM12R

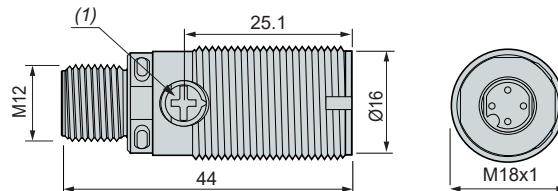

Line of sight: 90° to case axis (radial)

Transmitter

XUB2BKXWM12T

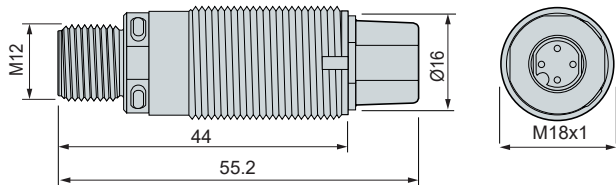

Receiver

XUB2BPYWM12R, XUB2BNXWM12R, XUB2BPXWM12R

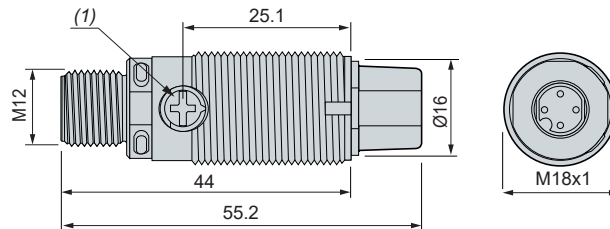

Thru-beam system, metal, pre-cabled version

Line of sight: along case axis (axial)

Transmitter

XUB2BKXNL2T

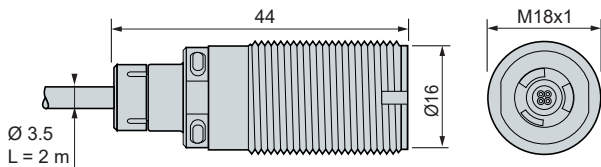

Receiver

XUB2BNXNL2R, XUB2BPXNL2R

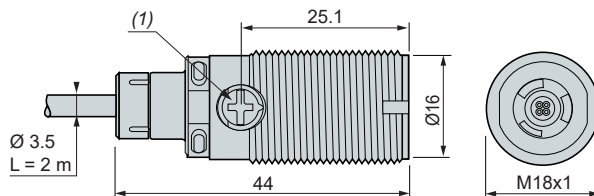

Line of sight: 90° to case axis (radial)

Transmitter

XUB2BKXWL2T

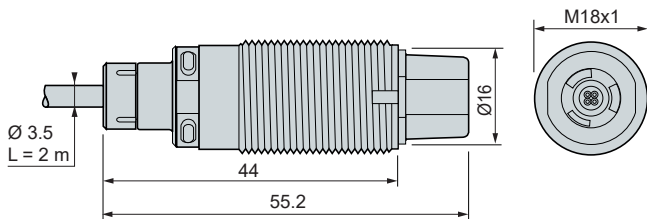

Receiver

XUB2BNXWL2R, XUB2BPXWL2R

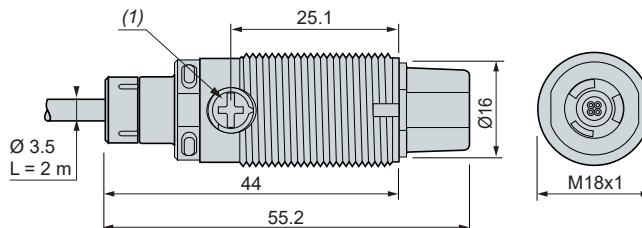

(1) Adjustment potentiometer (sensitivity).

Photo-electric sensors

XUB general purpose, single mode function

Cylindrical miniature design 18

Four-wire DC, solid-state output

Wire setting for NO/NC

Diffuse system, plastic, M12 connector version

Line of sight: along case axis (axial)

XUB5ANXNM12, XUB6ANXNM12, XUB5APXNM12, XUB6APXNM12, XUB5APYNM12 and XUB6APYNM12

Line of sight: 90° to case axis (radial)

XUB6ANXWM12, XUB6APXWM12 and XUB6APYWM12

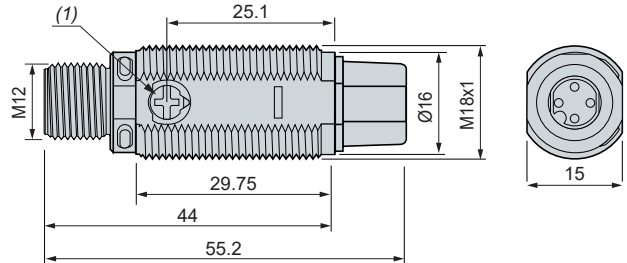
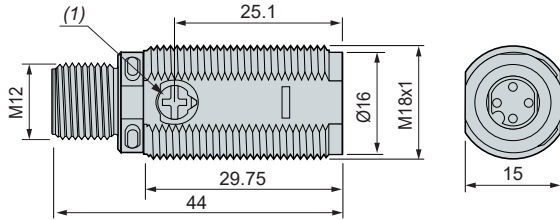

Diffuse system, plastic, pre-cabled version

Line of sight: along case axis (axial)

XUB5ANXL2, XUB6ANXL2, XUB5APXL2 and XUB6APXL2

Line of sight: 90° to case axis (radial)

XUB6ANXWL2 and XUB6APXL2

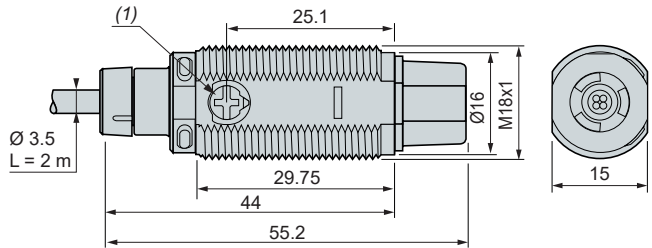
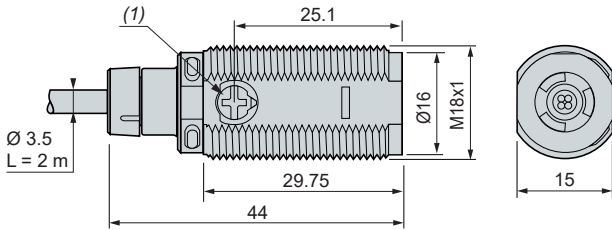

Diffuse system, metal, M12 connector version

Line of sight: along case axis (axial)

XUB5BNXNM12, XUB6BNXNM12, XUB5BPXNM12, XUB6BPXNM12, XUB5BPYNM12 and XUB6BPYNM12

Line of sight: 90° to case axis (radial)

XUB6BNXWM12, XUB6BPXWM12 and XUB6BPYWM12

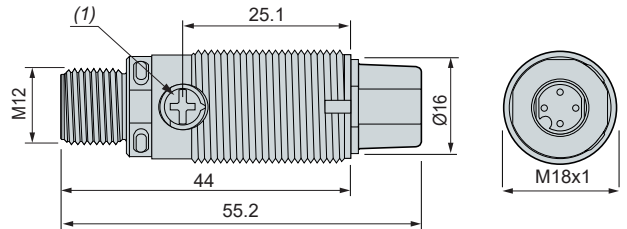
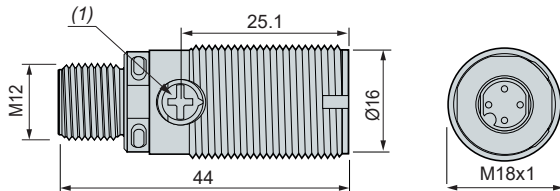

Diffuse system, metal, pre-cabled version

Line of sight: along case axis (axial)

XUB5BNXL2, XUB6BNXL2, XUB5BPXL2 and XUB6BPXL2

Line of sight: 90° to case axis (radial)

XUB6BNXWL2 and XUB6BPXL2

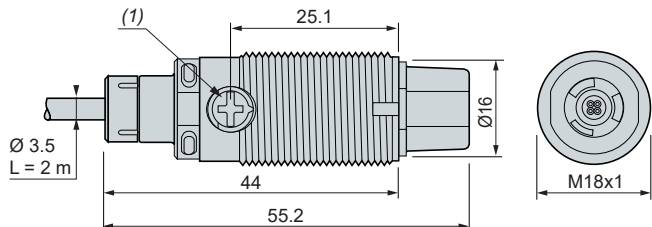
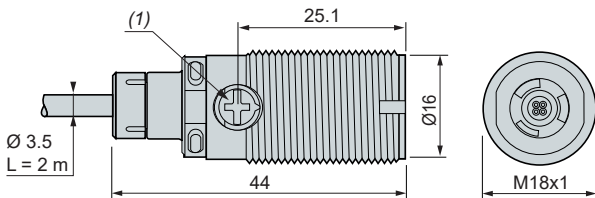

(1) Adjustment potentiometer (sensitivity).

Photo-electric sensors

XUB general purpose, single mode function

Cylindrical miniature design 18

Four-wire DC, solid-state output

Wire setting for NO/NC

Polarised reflex system, plastic, M12 connector version

Line of sight: along case axis (axial)

XUB9ANXNM12, XUB9APXNM12 and XUB9APYNM12

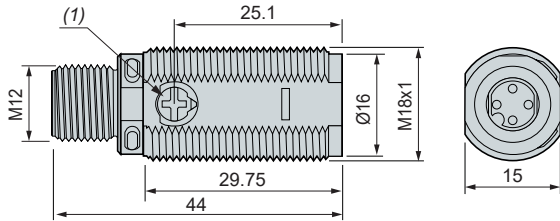

Line of sight: 90° to case axis (radial)

XUB9ANXWM12, XUB9APXWM12 and XUB9APYWM12

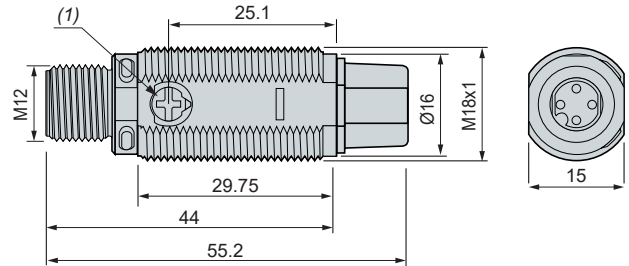

Polarised reflex system, plastic, pre-cabled version

Line of sight: along case axis (axial)

XUB9ANXNL2 and XUB9APXNL2

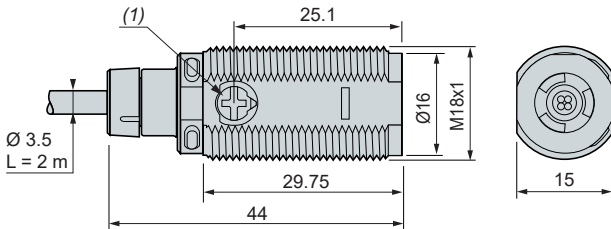

Line of sight: 90° to case axis (radial)

XUB9ANXWL2 and XUB9APXWL2

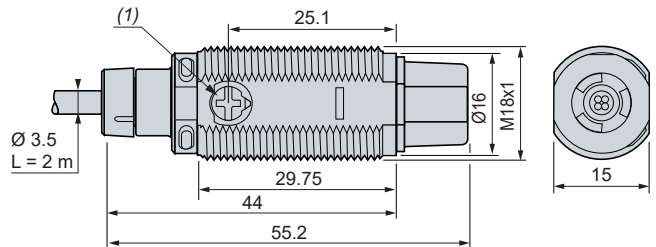

Polarised reflex system, metal, M12 connector version

Line of sight: along case axis (axial)

XUB9BNXNM12, XUB9BPXNM12 and XUB9BPYNM12

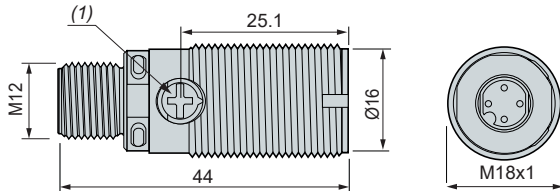

Line of sight: 90° to case axis (radial)

XUB9BNXWM12, XUB9BPXWM12 and XUB9BPYWM12

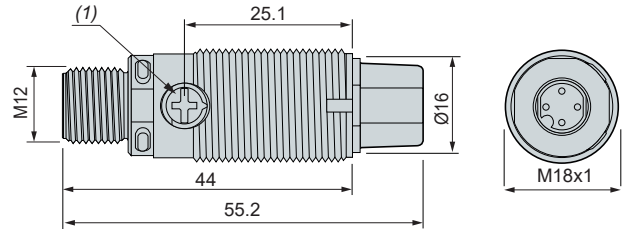

Polarised reflex system, metal, pre-cabled version

Line of sight: along case axis (axial)

XUB9BNXNL2 and XUB9BPXNL2

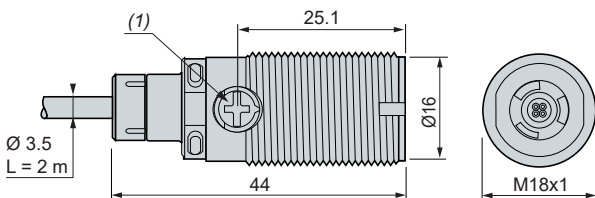

Line of sight: 90° to case axis (radial)

XUB9BNXWL2 and XUB9BPXWL2

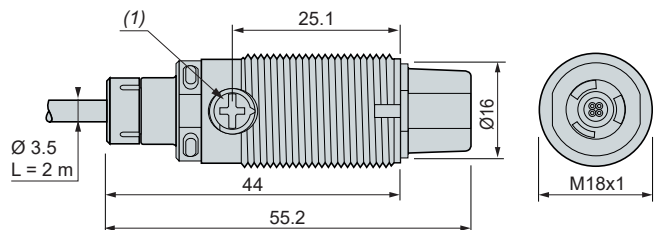

(1) Adjustment potentiometer (sensitivity).

Photo-electric sensors

XUN general purpose (1), single mode function
 Hybrid miniature design, plastic, thru-beam system
 Four-wire DC, solid-state output, wire setting for NO/NC

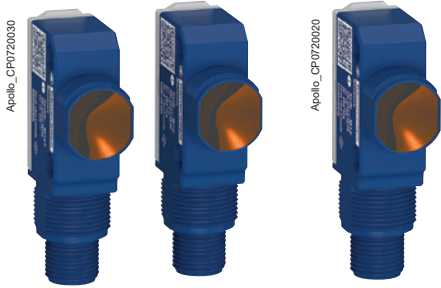

XUN2APYNM12



XUN2APYNM12R



XUN2ANXNL2
XUN2APXNL2



XUN2AKXNL2T



XUN2ANXNM12
XUN2APXNM12



XUN2AKXNM12T



XUN2ANXNL2R
XUN2APXNL2R



XUN2ANXNM12R
XUN2APXNM12R

Thru-beam system with adjustable sensitivity

Max./operating sensing distance (Sn)	Function	Output	Connection	Reference	Weight kg
--------------------------------------	----------	--------	------------	-----------	-----------

Transmitter + receiver IO-Link

30 m/20 m	NO (Dark ON)/ NC (Light ON) configuration by wire or IO-Link	Autodetect PNP/NPN	M12 connector (4-pin)	XUN2APYNM12	0 013
-----------	---	-----------------------	--------------------------	--------------------	-------

Transmitter + receiver

30 m/20 m	NO (Dark ON)/ NC (Light ON) configuration by wire	NPN	Pre-cabled (L = 2 m)	XUN2ANXNL2	0 040
			M12 connector (4-pin)	XUN2ANXNM12	0 013
		PNP	Pre-cabled (L = 2 m)	XUN2APXNL2	0 040
			M12 connector (4-pin)	XUN2APXNM12	0 013

Transmitter (2)

30 m/20 m			Pre-cabled (L = 2 m)	XUN2AKXNL2T	0 040
			M12 connector (4-pin)	XUN2AKXNM12T	0 013

Receiver IO-Link

30 m/20 m	NO (Dark ON)/ NC (Light ON) configuration by wire or IO-Link	Autodetect PNP/NPN	M12 connector (4-pin)	XUN2APYNM12R	0 013
-----------	---	-----------------------	--------------------------	---------------------	-------

Receiver

30 m/20 m	NO (Dark ON)/ NC (Light ON) configuration by wire	NPN	Pre-cabled (L = 2 m)	XUN2ANXNL2R	0 040
			M12 connector (4-pin)	XUN2ANXNM12R	0 013
		PNP	Pre-cabled (L = 2 m)	XUN2APXNL2R	0 040
			M12 connector (4-pin)	XUN2APXNM12R	0 013

Accessories

IO-Link Master (3)

See page 70 .

Fixing and other accessories

See page 74 .

Cabling accessories

See page 80 .

(1) Available 3rd quarter 2024

(2) All transmitters are compatible with the receivers listed below.

(3) Available 2nd quarter 2024.

Photo-electric sensors

XUN general purpose (1), single mode function
Hybrid miniature design, plastic, thru-beam system
Four-wire DC, solid-state output, wire setting for NO/NC



XUN5APYNM12
XUN6APYNM12



XUN5ANXNL2
XUN5APXNL2



XUN5ANXNM12
XUN5APXNM12



XUN6ANXNL2
XUN6APXNL2



XUN6ANXNM12
XUN6APXNM12

Diffuse system with adjustable sensitivity, IO-Link

Max./operating sensing distance (Sn)	Function	Output	Connection	Reference	Weight kg
Long range, red LED emission					
1 m/0.7 m	NO (Light ON)/ NC (Dark ON) configuration by wire or IO-Link	Autodetect PNP/NPN	M12 connector (4-pin)	XUN5APYNM12	0 013

Medium range, red LED emission

0.6 m/0.42 m	NO (Light ON)/ NC (Dark ON) configuration by wire or IO-Link	Autodetect PNP/NPN	M12 connector (4-pin)	XUN6APYNM12	0 013
--------------	---	-----------------------	--------------------------	--------------------	-------

Diffuse system with adjustable sensitivity

Max./operating sensing distance (Sn)	Function	Output	Connection	Reference	Weight kg
Long range, red LED emission					
1 m/0.7 m	NO (Light ON)/ NC (Dark ON) configuration by wire	NPN	Pre-cabled (L = 2 m)	XUN5ANXNL2	0 040
			M12 connector (4-pin)	XUN5ANXNM12	0 013

PNP	Pre-cabled (L = 2 m)	XUN5APXNL2	0 040
		M12 connector (4-pin)	XUN5APXNM12

Medium range, red LED emission

0.6 m/0.42 m	NO (Light ON)/ NC (Dark ON) configuration by wire	NPN	Pre-cabled (L = 2 m)	XUN6ANXNL2	0 040
			M12 connector (4-pin)	XUN6ANXNM12	0 013
PNP	Pre-cabled (L = 2 m)	XUN6APXNL2	0 040		
		M12 connector (4-pin)	XUN6APXNM12	0 013	

Accessories

IO-Link Master (2)

See page 70 .

Fixing and other accessories

See page 74 .

Cabling accessories

See page 80 .

(1) Available 3rd quarter 2024

(2) Available 2nd quarter 2024.

Photo-electric sensors

XUN general purpose (1), single mode function
 Hybrid miniature design, plastic, polarised reflex system
 Four-wire DC, solid-state output, wire setting for NO/NC



XUN9APYNM12



XUN9ANXNL2
 XUN9APXNL2



XUN9ANXNM12
 XUN9APXNM12

Polarised reflex system with adjustable sensitivity, IO-Link

Plastic, red LED emission

Max./operating sensing distance (Sn)	Function	Output	Connection	Reference	Weight kg
7 m/5 m	NO (Dark ON)/ NC (Light ON) configuration by wire or IO-Link	Autodetect PNP/NPN	M12 connector (4-pin)	XUN9APYNM12	0 013

Polarised reflex system with adjustable sensitivity

Plastic, red LED emission

Max./operating sensing distance (Sn)	Function	Output	Connection	Reference	Weight kg
7 m/5 m	NO (Dark ON)/ NC (Light ON) configuration by wire	NPN	Pre-cabled (L = 2 m)	XUN9ANXNL2	0 040
			M12 connector (4-pin)	XUN9ANXNM12	0 013
7 m/5 m	NO (Dark ON)/ NC (Light ON) configuration by wire	PNP	Pre-cabled (L = 2 m)	XUN9APXNL2	0 040
			M12 connector (4-pin)	XUN9APXNM12	0 013

Accessories

IO-Link Master (2)

See page 70 .

Fixing and other accessories

See page 74 .

Cabling accessories

See page 80 .

(1) Available 3rd quarter 2024

(2) Available 2nd quarter 2024.

Characteristics			
Sensor type		XUN2APYNM12, XUN2APYNM12R, XUN2A●XNM12, XU2AKXNM12T, XUN2A●XNM12R, XUN5APYNM12, XUN5A●XNM12, XUN6APYNM12, XUN6A●XNM12, XUN9APYNM12, XUN9A●XNM12	XUN2A●XNL2, XUN2A●XNL2R, XUN2AKXNL2T, XUN5A●XNL2, XUN6A●XNL2, XUN9A●XNL2
Product certifications		CE, UKCA, cULus	
Connection	Connector	M12	–
	Pre-cabled	–	Length: 2 m
Sensing distance Excess gain = 1 : maximum sensing distance Excess gain = 2 : nominal sensing distance	Thru-beam system XUN2	m	30 (with excess gain = 1) 20 (with excess gain = 2)
	Diffuse system XUN5 (using a white paper 200 x 200 mm)	m	1 (with excess gain = 1) 0.7 (with excess gain = 2)
	Diffuse system XUN6 (using a white paper 200 x 200 mm)	m	0.6 (with excess gain = 1) 0.42 (with excess gain = 2)
	Polarised reflex system XUN9 (using a 50 x 50 mm reflector XU2C50)	m	7 (with excess gain = 1) 5 (with excess gain = 2)
Blind zone		mm	0 (white object and potentiometer max.)
Sensing distance setting		Potentiometer 1 turn (+/- 220 degrees)	
Colour of detection light beam		Red (except XUB2 transmitter)	
Output type		PNP/NPN (or autodetect PNP/NPN with IO-Link)	
Hysteresis		2 % < H < 20 % at Sn	
Degree of protection	Conforming to IEC 60529	IP65, IP67	
	Conforming to DIN 40050-9	IP69K (M12 connector versions only)	
Artificial optical radiation	Conforming to IEC 62471	Class 0 (risk exempt)	
Radiated disturbances emissions	Conforming to EN 55011/CISPR 1	Class A	
Storage temperature		°C	-40...+70
Operating temperature		°C	-30...+55
Materials	Case	XUN2A, XUN5A, XUN6A and XUN9A: ABS	
	Lens cover	PMMA	
	Back cap	MABS	
	Potentiometer screw	PA66	
	Cable	–	PVC
Vibration resistance	Conforming to IEC 60068-2-6	Frequency range: 10 to 55 Hz Acceleration: 7 gn	
Shock resistance	Conforming to IEC 60068-2-27	Peak acceleration: 30 gn Duration of the pulse: 11 ms	
Rated supply voltage		V	12 . 24 --- with protection against reverse polarity
Voltage limits (including ripple)		V	10 . 30 ---
Current consumption, no-load		mA	< 20/IO-Link: < 30
Switching capacity		mA	100
Voltage drop, closed state		V	< 2 max.
Maximum switching frequency		Hz	1000
Delays	First-up	ms	< 100/IO-Link : < 300
	Response	ms	0.5 max.
	Recovery	ms	0.5 max

Photo-electric sensors

XUN general purpose, single mode function

Hybrid miniature design, plastic, thru-beam and diffuse systems

Four-wire DC, solid-state output, wire setting for NO/NC

Wiring schemes

Thru-beam system

M12 connector - 4 pins - IO-Link

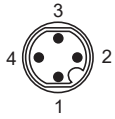

Pin	Signal	Definition
1	+	+ 24 V $\overline{\text{DC}}$
2	IN	+ = NO - = NC Open = NO
3	-	0 V $\overline{\text{DC}}$
4	Q	Switching signal (SIO)
C		IO-Link communication

Autodetect PNP/NPN or by IO-Link

XUN2APYNM12

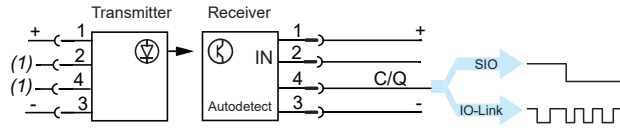

Note: IODD IO-Link files available on our website www.telemecaniquesensors.com/iolink

M12 connector - 4 pins

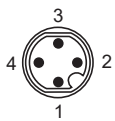

Pin	Signal	Definition
1	+	+ 24 V $\overline{\text{DC}}$
2	IN	+ = NO - = NC Open = NO
3	-	0 V $\overline{\text{DC}}$
4	Q	Switching signal (SIO)

PNP

XUN2APXNM12

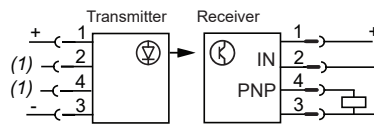

NPN

XUN2ANXNM12

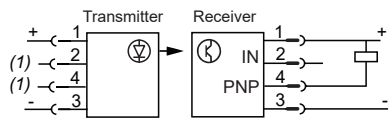

Pre-cabled - 4 wires

+BN (Brown)
IN (input) GY (Grey)
OUT (output) BK (Black)
-BU (Blue)

PNP

XUN2APXNL2

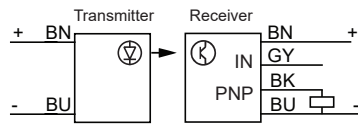

NPN

XUN2ANXNL2

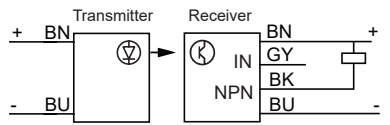

Diffuse system

M12 connector - 4 pins - IO-Link

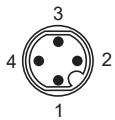

Pin	Signal	Definition
1	+	+ 24 V $\overline{\text{DC}}$
2	IN	+ = NO - = NC Open = NO
3	-	0 V $\overline{\text{DC}}$
4	Q	Switching signal (SIO)
C		IO-Link communication

Autodetect PNP/NPN or by IO-Link

XUN5APYNM12, XUN6APYNM12

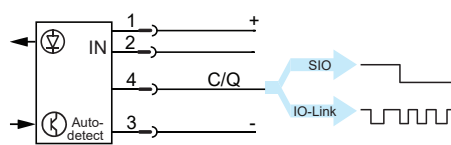

Note: IODD IO-Link files available on our website www.telemecaniquesensors.com/iolink

M12 connector - 4 pins

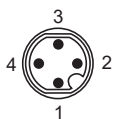

Pin	Signal	Definition
1	+	+ 24 V $\overline{\text{DC}}$
2	IN	+ = NO - = NC Open = NO
3	-	0 V $\overline{\text{DC}}$
4	Q	Switching signal (SIO)

PNP

XUN5APXNM12, XUN6APXNM12

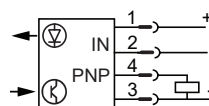

NPN

XUN5ANXNM12, XUN6ANXNM12

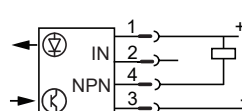

(1) Not connected

Photo-electric sensors

XUN general purpose, single mode function
 Hybrid miniature design, plastic, diffuse and polarised
 reflex systems
 Four-wire DC, solid-state output, wire setting for NO/NC

Wiring schemes (continued)

Diffuse system (continued)

Pre-cabled - 4 wires

+BN (Brown)
 IN (input) GY (Grey)
 OUT (output) BK (Black)
 -BU (Blue)

PNP

XUN5APXNL2, XUN6APXNL2

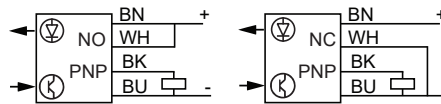

NPN

XUN5ANXNL12, XUN6ANXNL2,

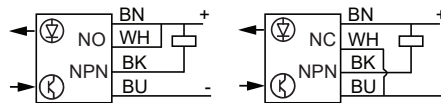

Polarised reflex system

M12 connector - 4 pins - IO-Link

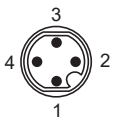

Pin	Signal	Definition
1	+	+ 24 V
2	IN	+ = NO - = NC Open = NO
3	-	0 V
4	Q	Switching signal (SIO)
C		IO-Link communication

Autodetect PNP/NPN or by IO-Link

XUN9APYNM12

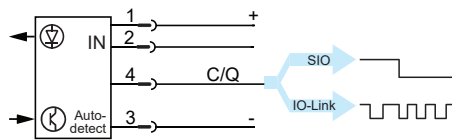

Note: IO-Link files available on our website www.telemecaniquesensors.com/iolink

M12 connector - 4 pins

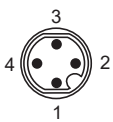

Control input IN:
 (+) = NO
 (-) = NC
 Open = NO

PNP

XUN9APXNM12

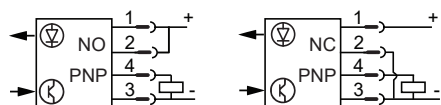

NPN

XUN9ANXNM12

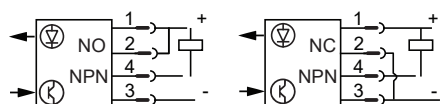

Pre-cabled - 4 wires

+BN (Brown)
 IN (input) GY (Grey)
 OUT (output) BK (Black)
 -BU (Blue)

PNP

XUN9APXNL2

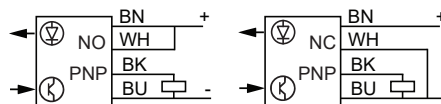

NPN

XUN9ANXNL12

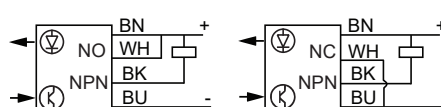

Photo-electric sensors

XUN general purpose, single mode function
 Hybrid miniature design, plastic, thru-beam system
 Four-wire DC, solid-state output, wire setting for NO/NC

Detection curves

Thru-beam system: XUN2

Lateral displacement

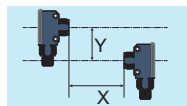
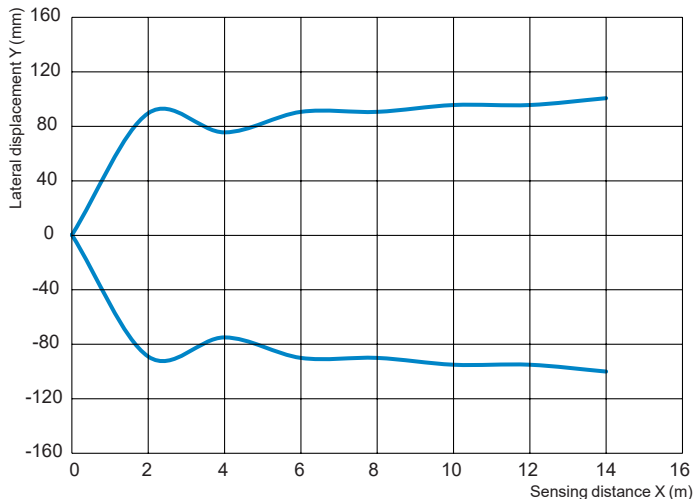

Light beam diameter

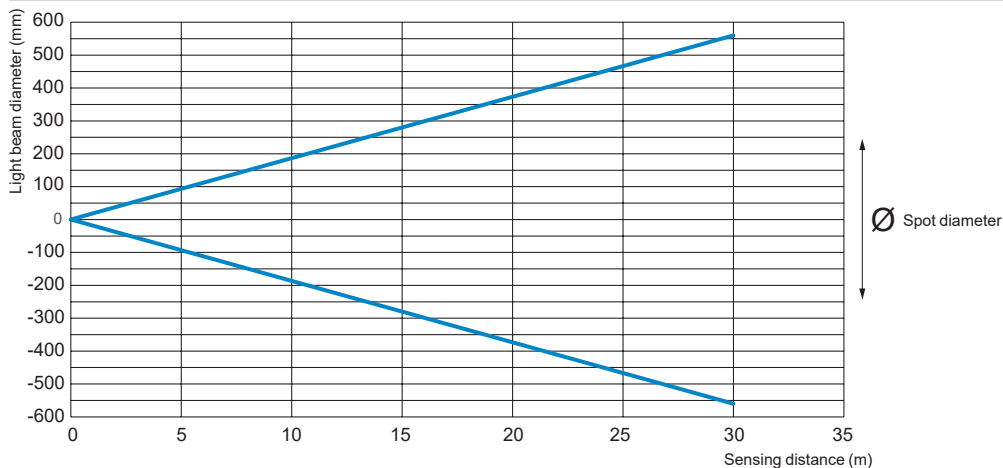

Excess gain

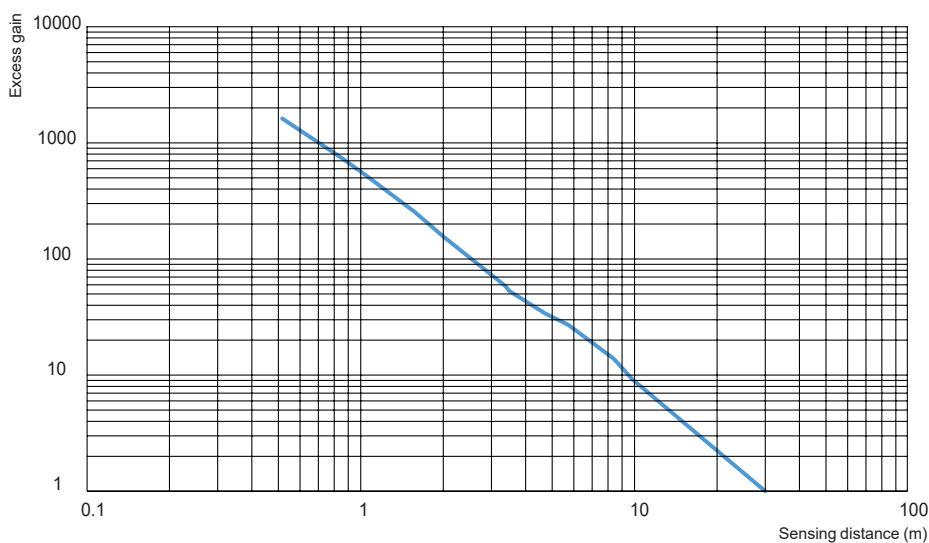

Photo-electric sensors

XUN general purpose, single mode function

Hybrid miniature design, plastic, diffuse system

Four-wire DC, solid-state output, wire setting for NO/NC

Detection curves (continued)

Diffuse system: XUN5 and XUN6

Minimum object size/sensing distance

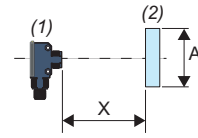
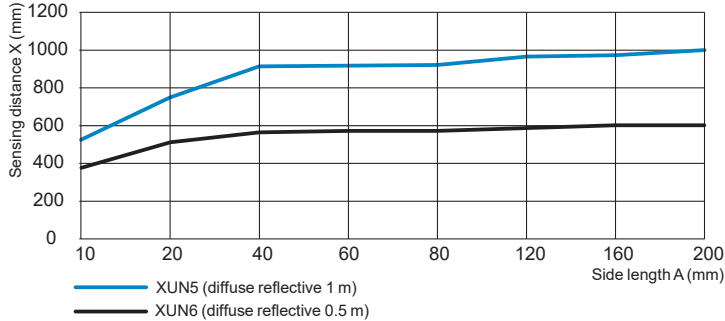

(1): Sensor
 (2): Object (white matt paper of A mm square)
 A: Side length (mm)
 X: Sensing distance (mm)

Lateral displacement

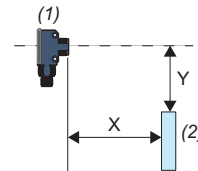
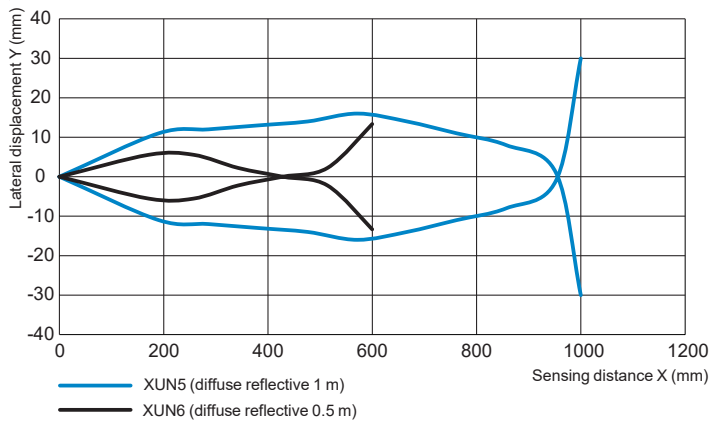

(1): Sensor
 (2): Object (200 mm square white paper)
 X: Sensing distance (mm)
 Y: Lateral displacement (mm)

Excess gain

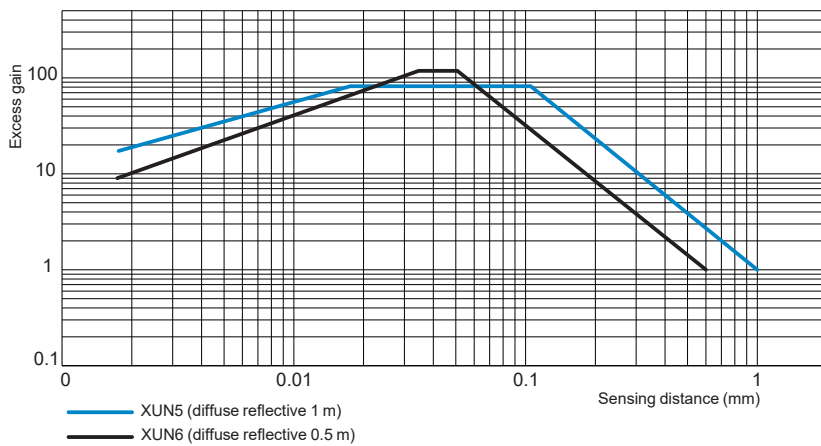

Photo-electric sensors

XUN general purpose, single mode function

Hybrid miniature design, plastic, polarised reflex system

Four-wire DC, solid-state output, wire setting for NO/NC

Detection curves (continued)

Polarised reflex system: XUN9

Reflector angle

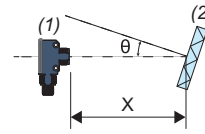
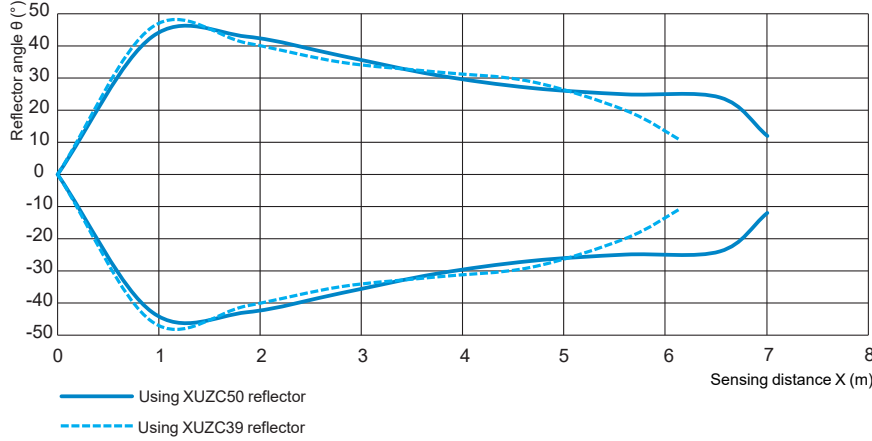

(1): Sensor
(2): Reflector
 θ : Reflector angle (°)
 X : Sensing distance (m)

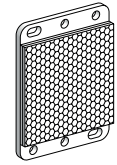

XUZH50



XUZH39

Lateral displacement

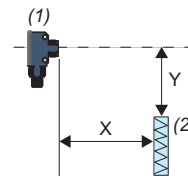
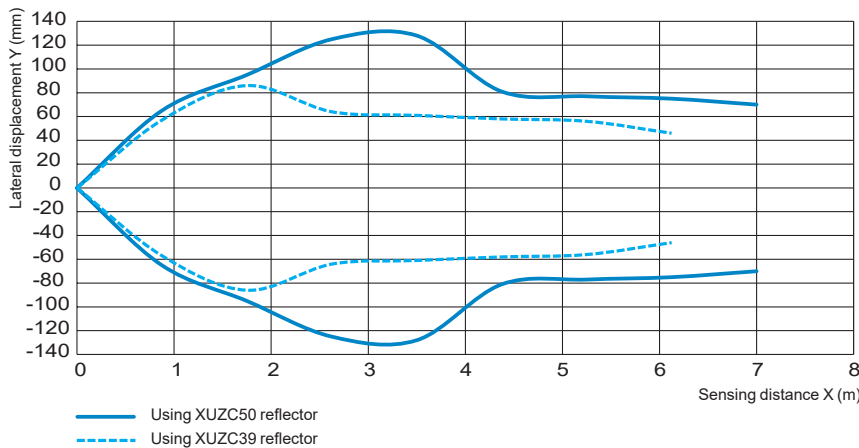

(1): Sensor
(2): Reflector
 Y : Lateral displacement (mm)
 X : Sensing distance (m)

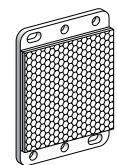

XUZH50



XUZH39

Excess gain

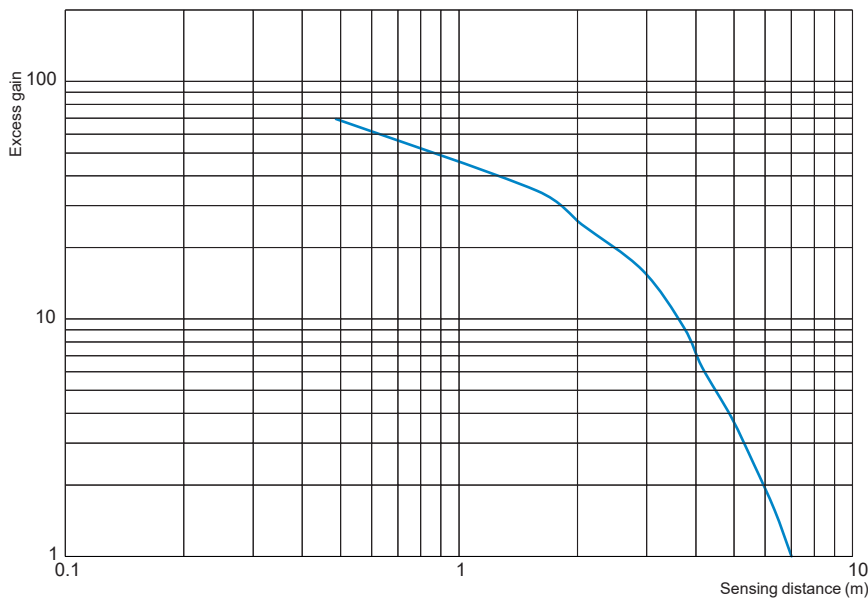

Photo-electric sensors

XUN general purpose, single mode function

Hybrid miniature design, plastic, thru-beam system

Four-wire DC, solid-state output, wire setting for NO/NC

Thru-beam system, plastic, M12 connector version

Transmitter + receiver (common top, side and front views)

XUN2APYNM12, XUN2ANXNM12, XUN2APXNM12

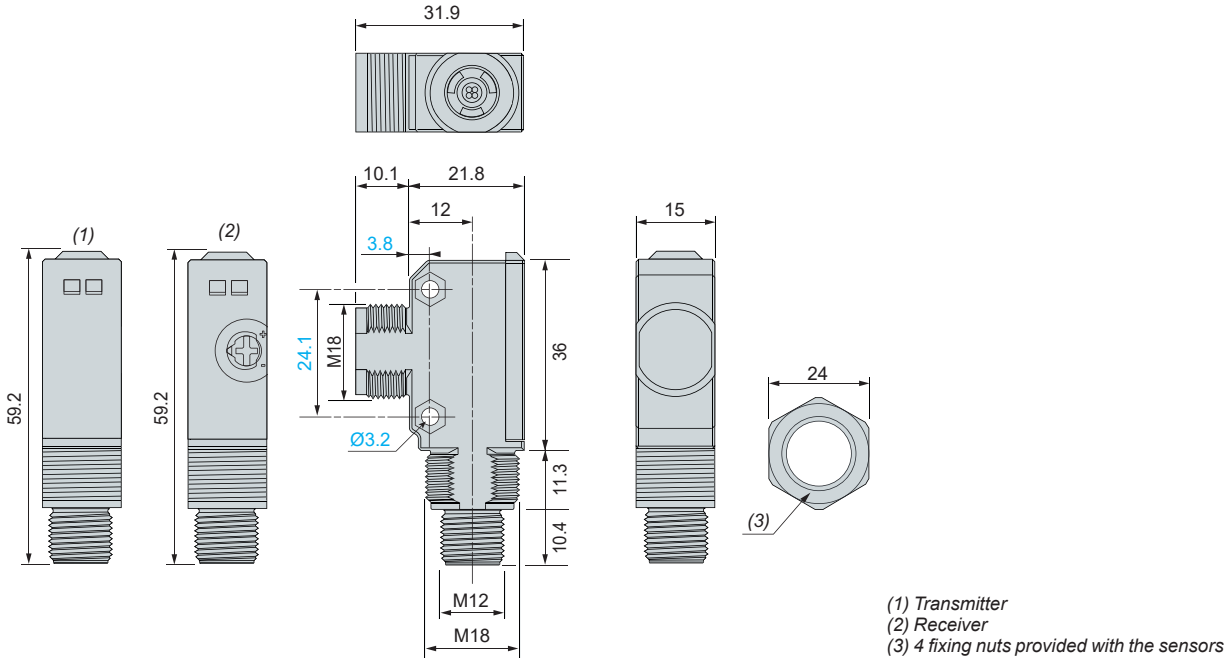

Transmitter only

XUN2AKXNM12T

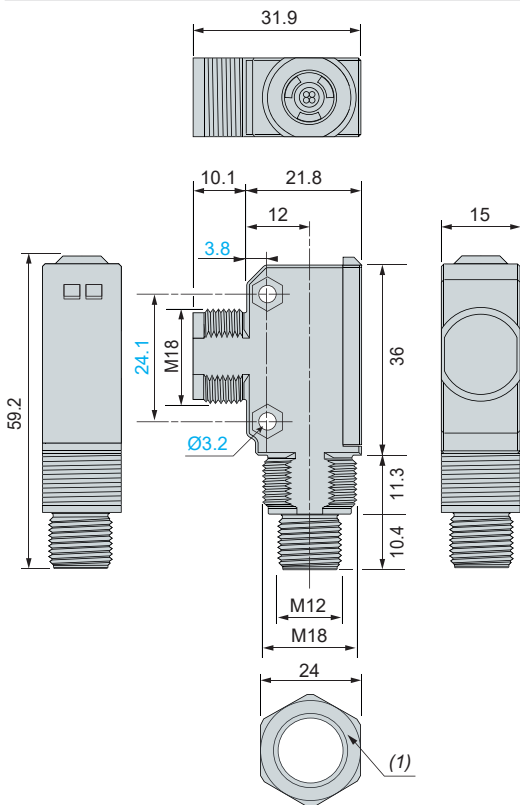

Receiver only

XUN2APYNM12R, XUN2ANXNM12R, XUN2APXNM12R

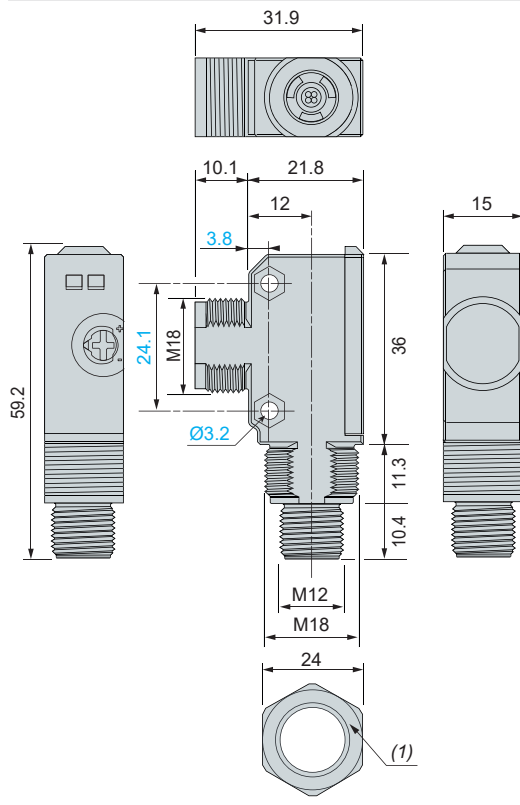

(1) 2 fixing nuts provided with the sensor.

Photo-electric sensors

XUN general purpose, single mode function

Hybrid miniature design, plastic, thru-beam system

Four-wire DC, solid-state output, wire setting for NO/NC

Thru-beam system, plastic, pre-cabled version

Transmitter + receiver (common top, side and front views)

XUN2ANXNL2, XUN2APXNL2

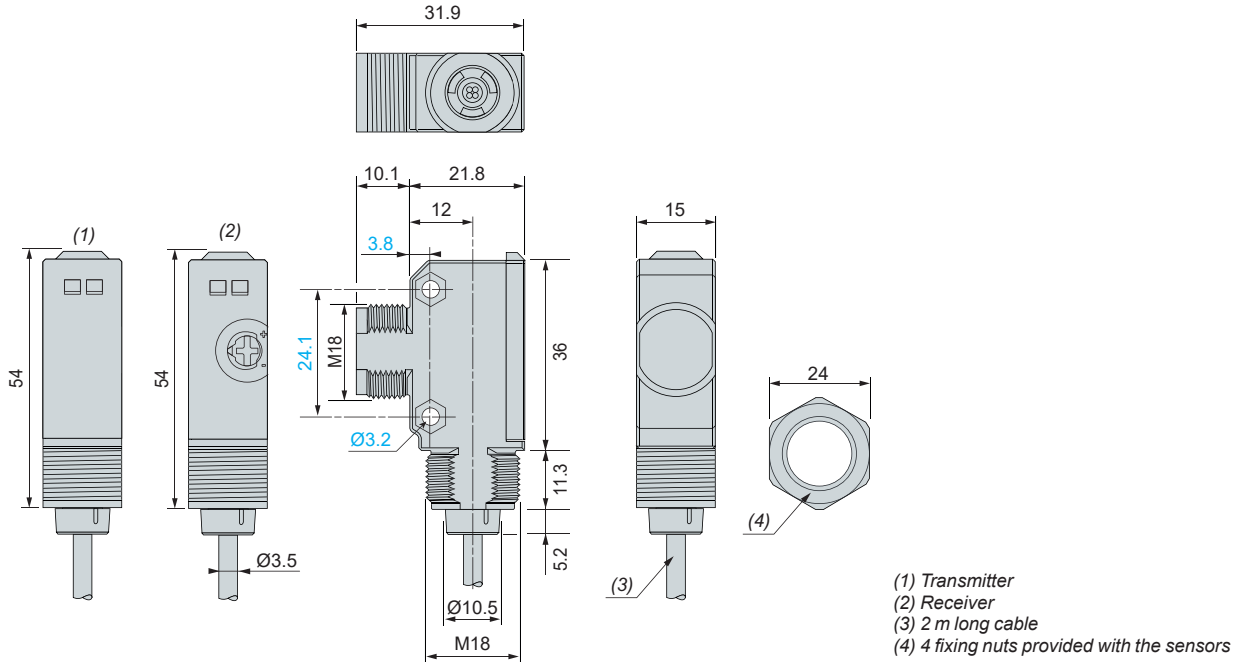

Transmitter only

XUN2AKXNL2T

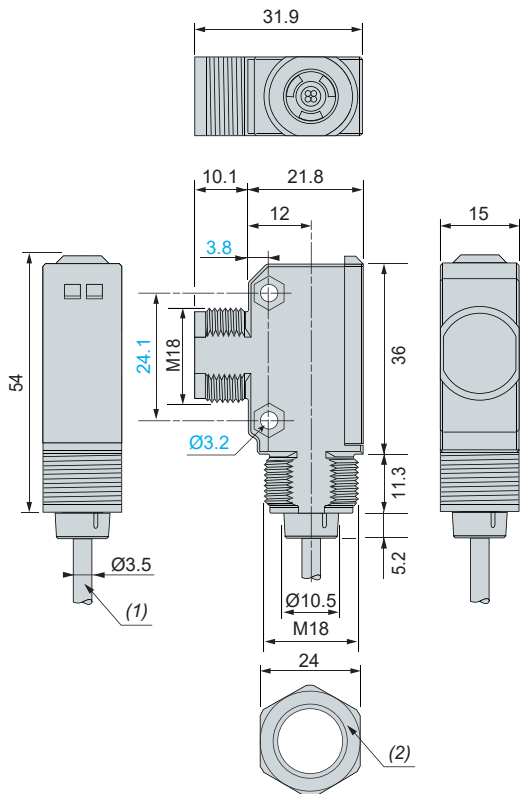

Receiver only

XUN2ANXNL2R, XUN2APXNL2R

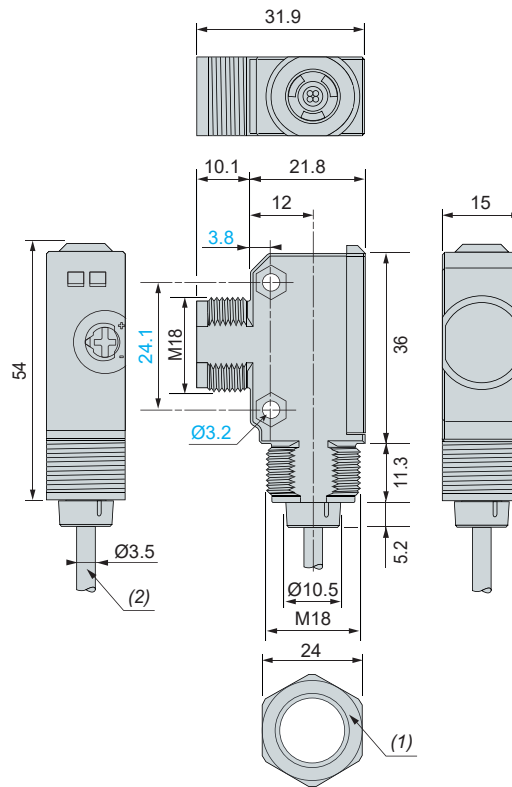

(1) 2 m long cable.
 (2) 2 fixing nuts provided with the sensor.

Photo-electric sensors

XUN general purpose, single mode function
 Hybrid miniature design, plastic, diffuse and polarised
 reflex systems
 Four-wire DC, solid-state output, wire setting for NO/NC

Diffuse system, M12 connector version

Long range or medium range, red LED emission
 XUN5APYNM12, XUN5ANXNM12, XUN5APXNM12,
 XUN6APYNM12, XUN6ANXNM12, XUN6APXNM12

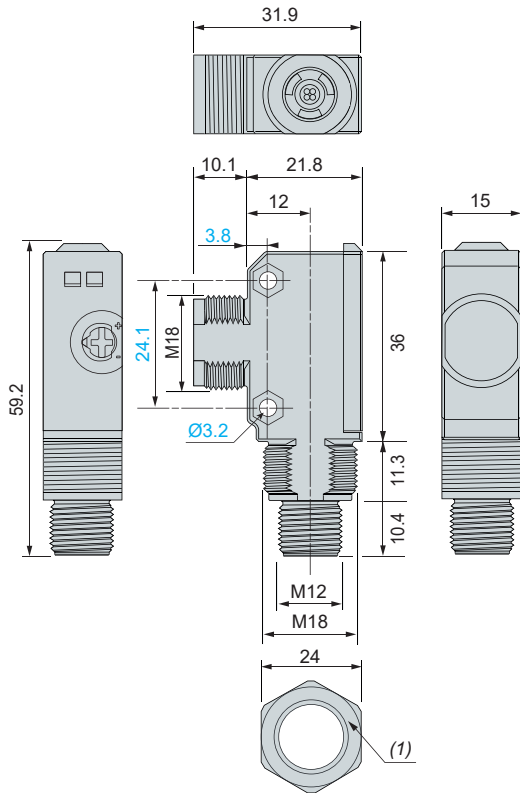

Diffuse system, pre-cabled version

Long range or medium range, red LED emission
 XUN5ANXNL2, XUN5APXNL2, XUN6ANXNL2, XUN6APXNL2

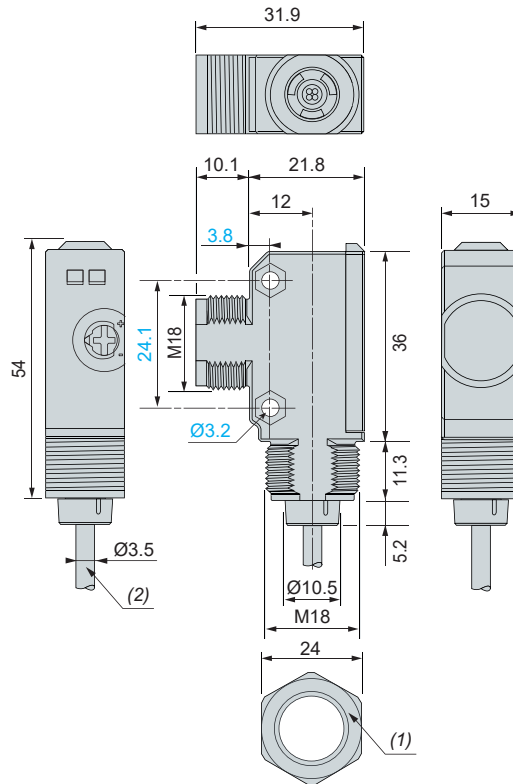

Polarised reflex system, M12 connector version

XUN9APYNM12, XUN9ANXNM12, XUN9APXNM12

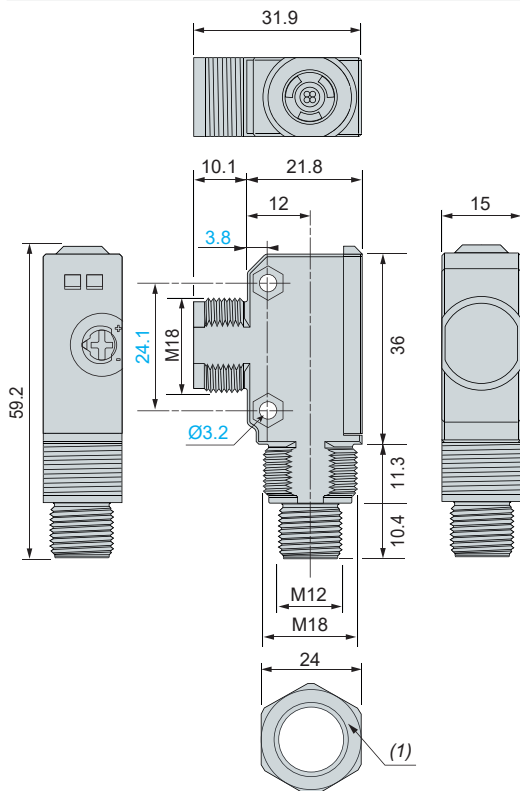

Polarised reflex system, pre-cabled version

XUN9ANXNL2, XUN9APXNL2

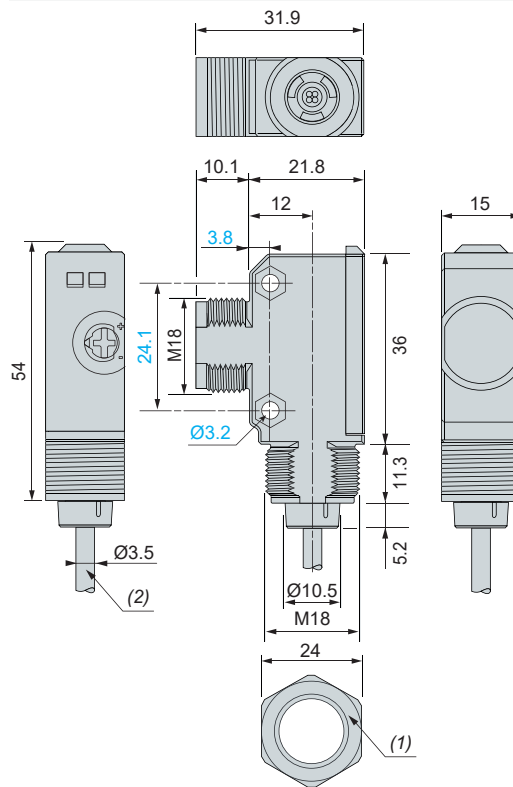

(1) 2 fixing nuts provided with the sensor.
 (2) 2 m long cable.



XU photo-electric sensors
for packaging, food & beverage

Telemecanique Sensors presents an expanded XU range of application photo-electric sensors to be embedded in automated lines for the packaging market segment .

With their diverse technical characteristics, high performance and smart management capabilities, they are designed to address a wide scope of specific needs .



Packaging



Handling



Food and Beverage

Fast object detection

Sensor family per application

- > Marking detection
- > Very dark and light-absorbing object detection
- > Accurate detection
- > Colour object detection, from simple colour to very complex colour sorting
- > Transparent object detection, with or without reflector



Five light spots

Select the perfectly suitable light spot

- > **Laser light:** to detect very small objects and contrast marks with pinpoint accuracy, even at a long sensing distance
- > **White light:** for simple contrast detection (high contrast), short distances
- > **Blue light:** for low-reflectivity objects, especially dark ones. Blue light short waves mean less penetration, resulting in higher surface reflection.
- > **Red light:** for detecting objects at a long distance and for very absorbing objects
- > **RGB light :** for more accurate contrast in colour prints



Laser



Red light



White light



Blue light



RGB



Designed for small spaces in packaging machines

Choose the casing, connection type and size

- > Plastic or metal casing
- > Pre-cabled, with pigtail or connector
- > Miniature, sub-miniature and compact size



Simple communication with the PLC via Ethernet

Smart devices communicate via IO-Link protocol

- > Install your new IO-Link sensor easily: automatic reading of the device identification file (IODD) and automatic detection of the sensor output mode
- > Automated parameter settings: configure the detection parameters
- > Extended diagnostics, with real-time information for optimised usage and maintenance

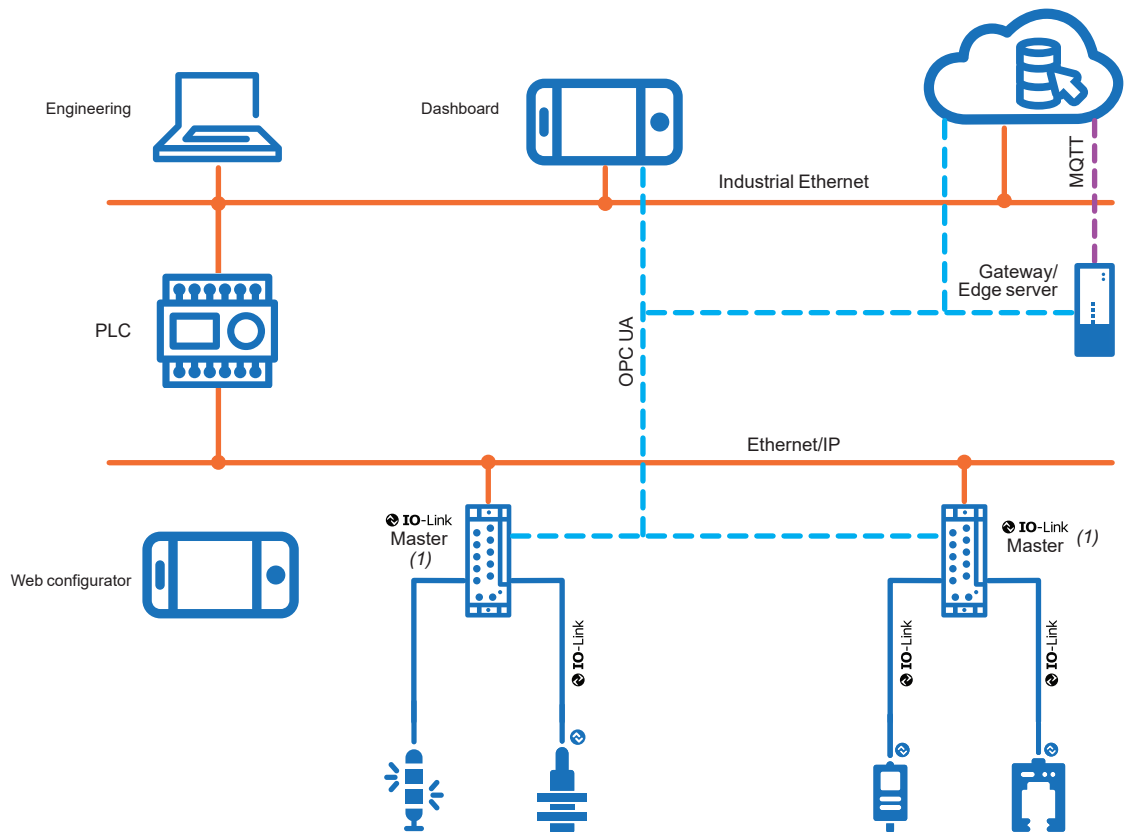
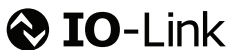

(1) Available 2nd quarter 2024.

Photo-electric sensors

XU application, for marking detection
Miniature and compact design, plastic



XUMRAWAYM8
XUMRAGAYM8
XUMRACAYM8



XUMRAWAYP015
XUMRAGAYP015



XUM5ALAYM8



XUM5ALAYL2

Contrast mark reader sensors IO-Link

Max./operating sensing distance (Sn)	Function	Output	Connection	Reference	Weight kg
--------------------------------------	----------	--------	------------	-----------	-----------

White light

15 mm/12 mm	NO/NC configuration via teach-in or IO-Link	Autodetect PNP/NPN	M8 connector (4-pin)	XUMRAWAYM8	0 018
		Autodetect PNP/NPN	Pigtail M12 (L= 0.15 m)	XUMRAWAYP015	0 027

RGB light

15 mm/12 mm	NO/NC configuration via Teach-in or IO-Link	Autodetect PNP/NPN	M8 connector (4-pin)	XUMRAGAYM8	0 018
		Autodetect PNP/NPN	Pigtail M12 (L= 0.15 m)	XUMRAGAYP015	0 027
		Autodetect PNP/NPN	M8 connector (4-pin)	XUMRACAYM8	0 018

Laser light

250 mm/150 mm	NO/NC configuration via Teach-in or IO-Link	Autodetect PNP/NPN	Pre-cabled (L = 2 m)	XUM5ALAYL2	0 045
		Autodetect PNP/NPN	M8 connector (4-pin)	XUM5ALAYM8	0 018
		Autodetect PNP/NPN	Pigtail M12 (L= 0.15 m)	XUM5ALAYP015	0 026

Accessories

IO-Link Master (1)

See page 70 .

Fixing and other accessories

See page 74 .

Cabling accessories

See page 80 .

(1) Available 2nd quarter 2024.

Photo-electric sensors

XU application, for marking detection
Miniature and compact design, plastic

Characteristics			
Sensor type		XUMRA●AYM8	XUM5ALAY●●
Product certifications		CE, UKCA, cULus, Ecolab	
Connection	Connector	M8	M8
	Pigtail	M12 Length: 0.15 m	M12 Length: 0.15 m
	Pre-cabled	–	Length: 2 m
Maximum sensing distance S _{max}	Contrast mark reader	mm 15	250
Detection light beam colour		White LED RGB (red, green, blue)	Red (laser class 1)
Degree of protection	Conforming to IEC 60529	IP67	
	Conforming to DIN 40050-9	IP69K	
Storage temperature		°C -20 . +80	
Operating temperature		°C -20 . +55	-20 . +60
Materials	Case	ABS	
	Lens	PMMA	
	Front	PMMA	
	Cable	PVC	
Rated supply voltage		V 12 . 24 ---	
Voltage limits (including ripple)		V 10 . 30 ---	
Current consumption, no-load		mA ≤ 30 for RGB ≤ 25 for white light	≤ 30
Switching capacity		mA 100	
Maximum switching frequency		Hz 10,000 for XUMRAW and XUMARG 2500 for XUMRAC	4000
Delays	First-up	ms 300	
	Response	µs 50 for XUMRAW and XUMARG 200 for XUMRAC	125
	Recovery	ms 300	

Wiring schemes

Contrast mark reader systems

M8/M12 connector - 4-pin - IO-Link

Pin	Signal	Definition
1	+	+ 24 V $\overline{\text{DC}}$
2	IN	+ = NO - = NC Open = NO
3	-	0 V $\overline{\text{DC}}$
4	Q	Switching signal (SIO)
	C	Communication (IO-Link)

Autodetect PNP/NPN or by IO-Link

XUM●A●AYM8, XUM●A●AYP015 (white, RGB and laser)

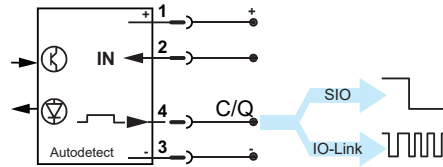

Note: IODD IO-Link files available on our website www.telemecaniquesensors.com/iolink

Pre-cabled - 4-wire - IO-Link

Pin	Signal	Definition
1	+	+ 24 V $\overline{\text{DC}}$
2	IN	+ = NO - = NC Open = NO
3	-	0 V $\overline{\text{DC}}$
4	C	Switching signal (SIO) Communication (IO-Link)

Autodetect PNP/NPN or by IO-Link

XUM5ALAYL2 (laser)

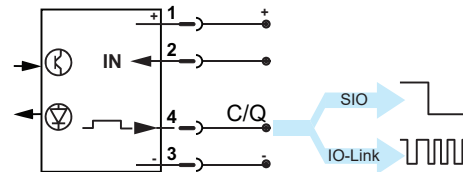

Detection curves

Contrast mark reader system: XUMRA●AYM8, XUMRA●AYP015

Signal process

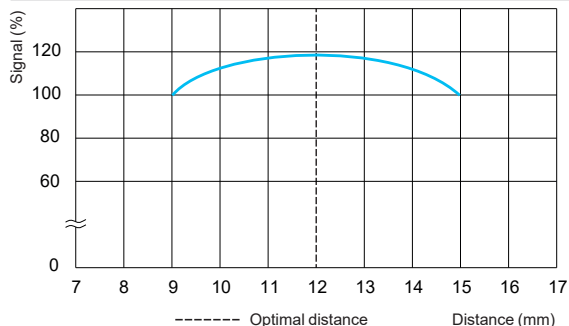

Contrast mark reader system: XUM5ALAY●●

Light spot size

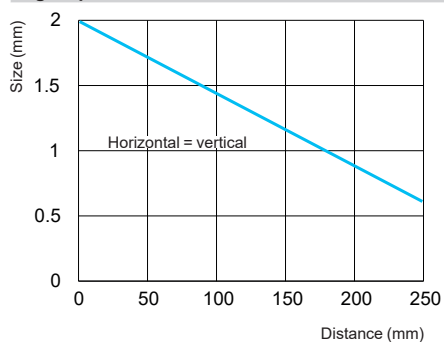

Excess gain

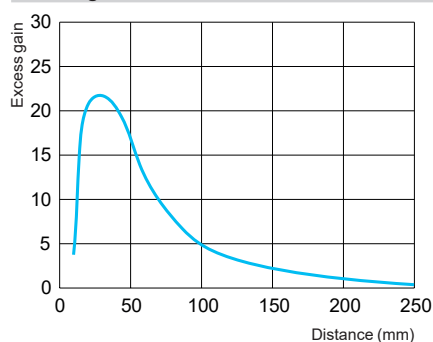

Dimensions

Miniature format: XUM

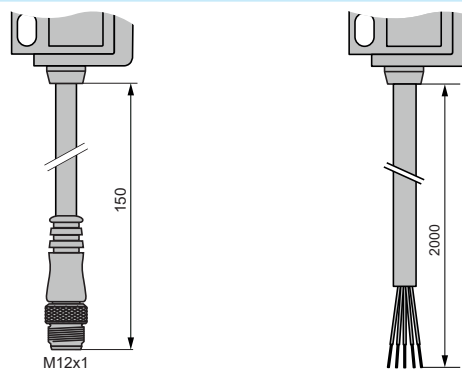
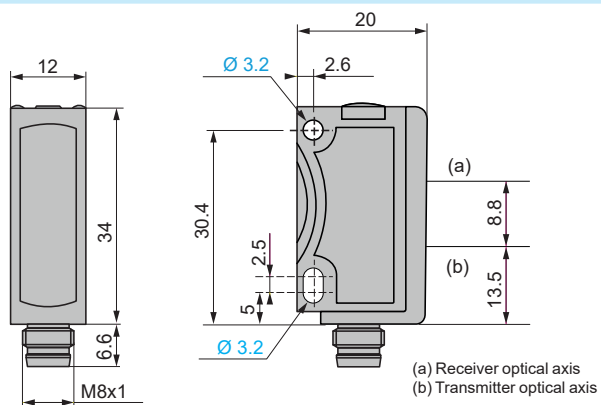

Compact format: XUK

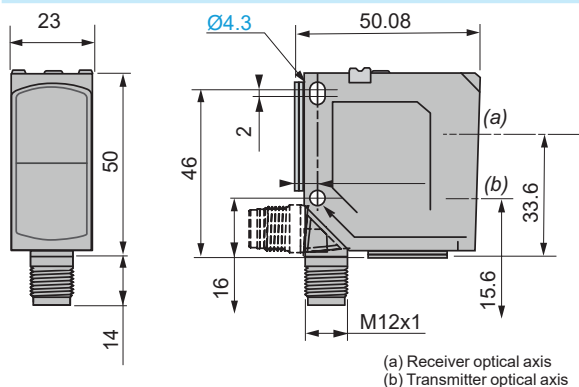

Photo-electric sensors

XU application, for very dark object detection
Miniature, sub-miniature and compact design, plastic



XUM8ABAYP015



XUM7ABPXM8,
XUM8ABAYM8

XUM7ABPXL2



XUT7ABPXL2,
XUT8ABAYL2

XUT7ABPXP02,
XUT8ABAYP02



XUK8ABPXM12

Background suppression sensors IO-Link

Max./operating sensing distance (Sn)	Function	Output	Connection	Reference	Weight kg
Adjustable blue light					
200 mm/200 mm (miniature format)	NO/NC configuration via teach-in or IO-Link	Autodetect PNP/NPN	M8 connector (4-pin)	XUM8ABAYM8	0 014
		Autodetect PNP/NPN	Pigtail M12 (L= 0.15 m)	XUM8ABAYP015	0 027
100 mm/100 mm sub-miniature format	NO/NC configuration via teach-in or IO-Link	Autodetect PNP/NPN	Pre-cabled (L = 2 m)	XUT8ABAYL2	0 031
		Autodetect PNP/NPN	Pigtail M8 (L = 0.2 m)	XUT8ABAYP02	0 019

Background suppression sensors

Fixed blue light, miniature format					
100 mm/80 mm	NO/NC configuration via teach-in	PNP	Pre-cabled (L = 2 m)	XUM7ABPXL2	0 056
		PNP	M8 connector (4-pin)	XUM7ABPXM8	0 017

Fixed blue light, sub-miniature format

50 mm/50 mm	NO/NC configuration via teach-in	PNP	Pre-cabled (L = 2 m)	XUT7ABPXL2	0 031
		PNP	Pigtail M8 (L = 0.2 m)	XUT7ABPXP02	0 022

Adjustable blue light (potentiometer)

1200 mm/600 mm	NO/NC configuration via teach-in	PNP	M12 connector (4-pin)	XUK8ABPXM12	0 046
----------------	----------------------------------	-----	-----------------------	--------------------	-------

Accessories

IO-Link Master (1)

See page 70 .

Fixing and other accessories

See page 74 .

Cabling accessories

See page 80 .

(1) Available 2nd quarter 2024.

Characteristics				XU●7ABPX●●	XU●8ABAY●●	XUK8ABPXM12	
Sensor type				XU●7ABPX●●	XU●8ABAY●●	XUK8ABPXM12	
Product certifications				CE, UKCA, cULus, Ecolab			
Connection	Connector			M8	M8	M12	
	Pre-cabled			Length = 2 m	Length = 2 m	–	
	Pigtail			Length = 0.2 m	Length = 0.15 m for XUM8 Length = 0.2 m for XUT8	–	
Maximum sensing distance Smax	BGS, fixed blue light	XUM7	mm	100	–	–	
		XUT7	mm	50	–	–	
	BGS, adjustable blue light	XUM8	mm	–	200	–	
		XUT8	mm	–	100	–	
		XUK8	mm	–	–	1200	
Detection light beam colour				Blue			
Degree of protection	Conforming to IEC 60529			IP67			
	Conforming to DIN 40050-9			IP69K for XUM7 only	IP69K for XUM8 only	IP69K	
Storage temperature				°C	-20 . +80		
Operating temperature				°C	-20 . +60 for XUM7 -20 . +50 for XUT7	-20 . +60	
Materials	Case			ABS for XUM7 PUR for XUT7	ABS for XUM8 PUR for XUT8	ABS/PC	
	Lens			PMMA			
	Front			PMMA		–	
	Cable			PVC		–	
Rated supply voltage				V	12 . 24 ---	24 --- for XUT8 12 . 24 --- for XUM8	12 . 24 ---
Voltage limits (including ripple)				V	13 . 30 for XUT8		
Current consumption, no-load				mA	≤ 30 for XUM		≤ 30
				mA	≤ 20 for XUT		
Switching capacity				mA	≤ 100 for XUM		≤ 100
				mA	≤ 50 for XUT		
Maximum switching frequency				Hz	1000	700	600
Delays	First-up		ms	< 300			
	Response		µs	500	700 for XUT 500 for XUM	830 max.	
	Recovery		ms	< 300		300 max.	

Wiring schemes

Background suppression system

M8 connector (including pigtail) - 4-pin



Pin	Signal	Definition
1	+	+ 24 V $\overline{\text{---}}$
2	IN	+ = NC - = NO Open = NO
3	-	0 V $\overline{\text{---}}$
4	Q	Switching signal

PNP XUM7ABPXM8, XUT7ABPXP02

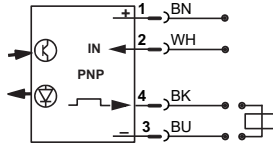

Pre-cabled - 4-wire

- +BN (Brown)
- IN (input) GY (Grey)
- OUT (output) BK (Black)
- BU (Blue)

PNP XUT7ABPXL2, XUM7ABPXL2

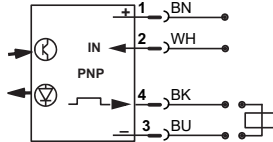

M8/M12 connector - 4-pin IO-Link



M8

Pin	Signal	Definition
1	+	+ 24 V $\overline{\text{---}}$
2	IN	+ = NO - = NC Open = NO
3	-	0 V $\overline{\text{---}}$
4	C	Communication (IO-Link)



M12

Autodetect PNP/NPN or by IO-Link XUM8ABAYM8, XUM8ABAYP015, XUT8ABAYP02

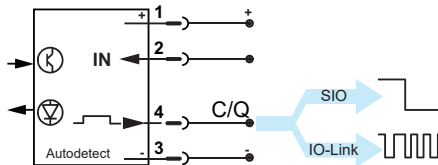

Note: IO-Link files available on our website www.telemecaniquesensors.com/iolink

Wiring schemes

Background suppression system

Pre-cabled - 4-wire IO-Link

Pin	Signal	Definition
1	+	+ 24 V $\overline{\text{---}}$
2	IN	+ = NO - = NC Open = NO
3	-	0 V $\overline{\text{---}}$
4	C	Switching signal (SIO) Communication (IO-Link)

Autodetect PNP/NPN or by IO-Link

XUT8ABAYL2

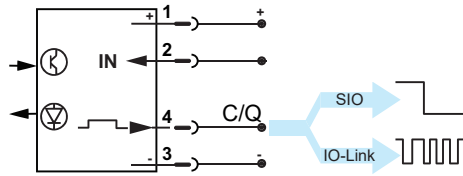

Note: IO-Link files available on our website www.telemecaniquesensors.com/iolink

M12 connector - 4-pin



Pin	Signal	Definition
1	+	+ 24 V $\overline{\text{---}}$
2	IN	+ = NC - = NO Open = NO
3	-	0 V $\overline{\text{---}}$
4	C	Switching signal

PNP

XUK8ABPXM12

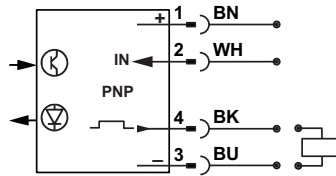

Detection curves

Background suppression system

Scanning properties: XUM8ABAY●●

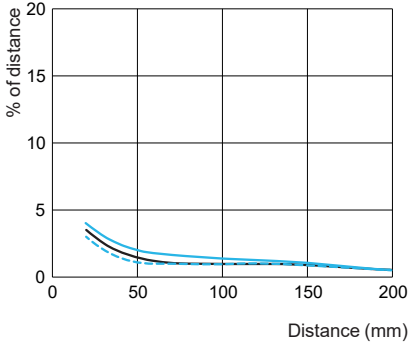

Scanning properties: XUT8ABAY●●

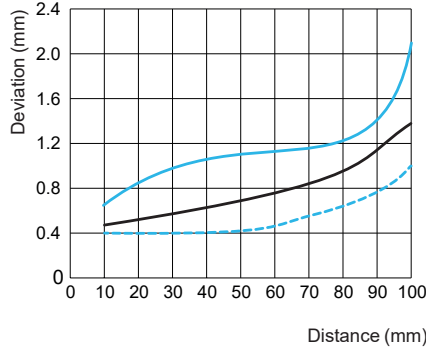

Light spot size: XUT8ABAY●●

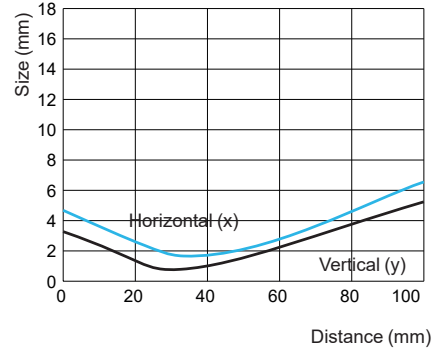

--- Min .distance white object (90%)/white background (90%) (mm)
— Min .distance grey object (18%)/white background (90%) (mm)
— Min .distance black object (6%)/white background (90%) (mm)

Light spot size: XUM7ABPX●●

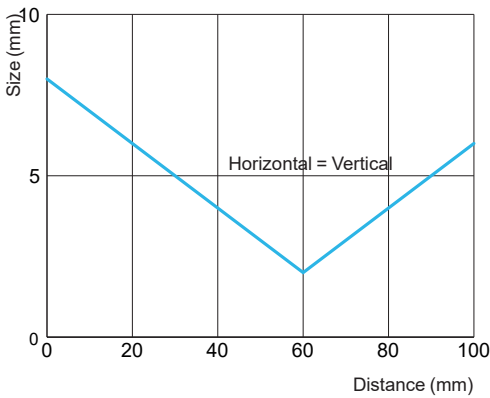

Light spot size: XUT7ABPX●●

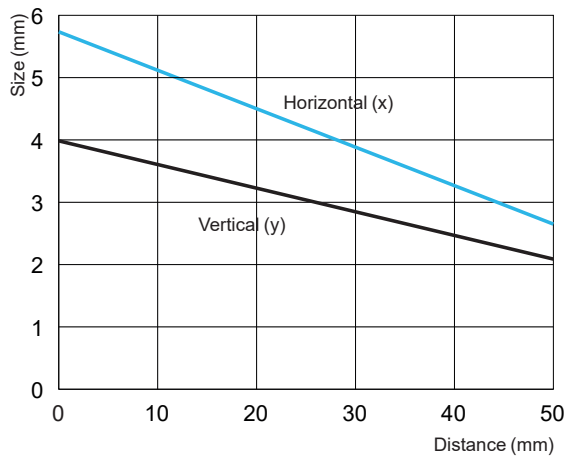

Scanning properties: XUK8ABPXM12

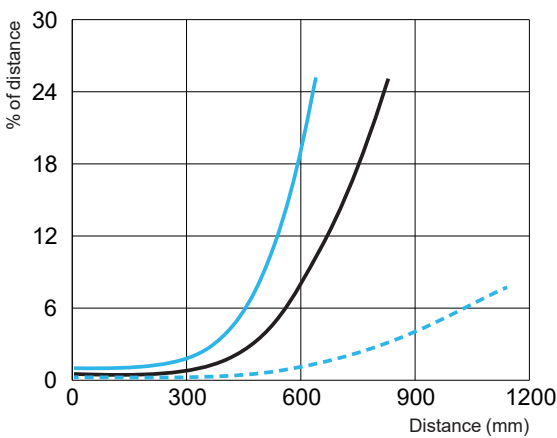

Light beam diameter: XUK8ABPXM12

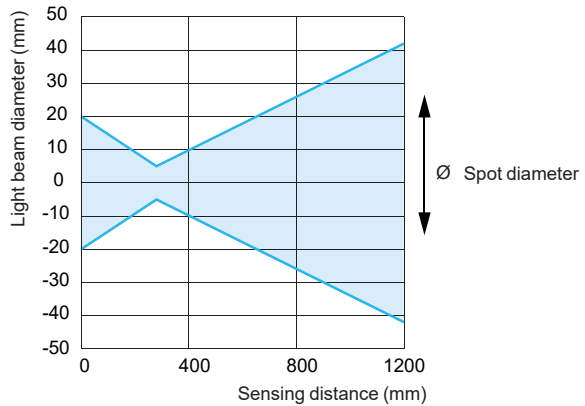

--- Min .distance white object (90%)/white background (90%) (mm)
— Min .distance grey object (18%)/white background (90%) (mm)
— Min .distance black object (6%)/white background (90%) (mm)

Photo-electric sensors

XU application, for very dark object detection
Miniature, sub-miniature and compact design, plastic

Dimensions

Miniature format: XUM

XUM7ABPXL2, XUM8ABAYM8

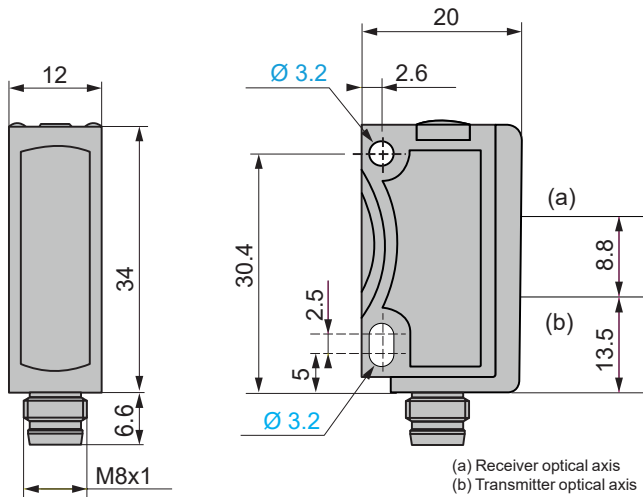

XUM8ABAYP015

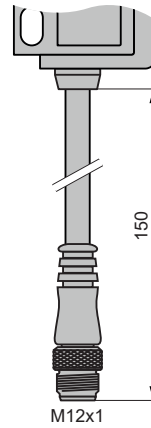

XUM7ABPXL2

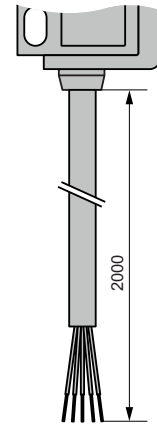

Sub-miniature format: XUT

XUT7ABPXP02, XUT7ABPXL2, XUT8ABAYP02, XUT8ABAYL2

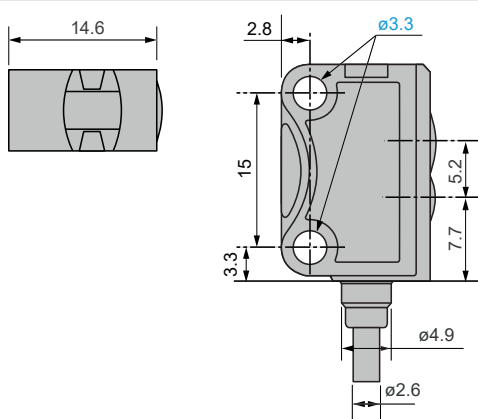

XUT●●●●●P02

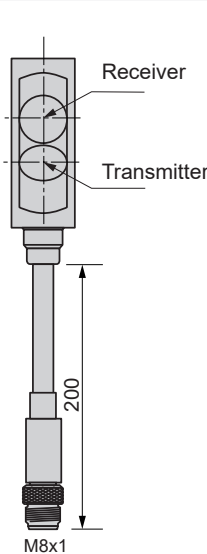

XUT●●●●●L2

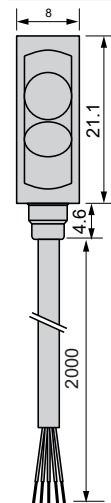

Compact format

XUK8ABPXM12

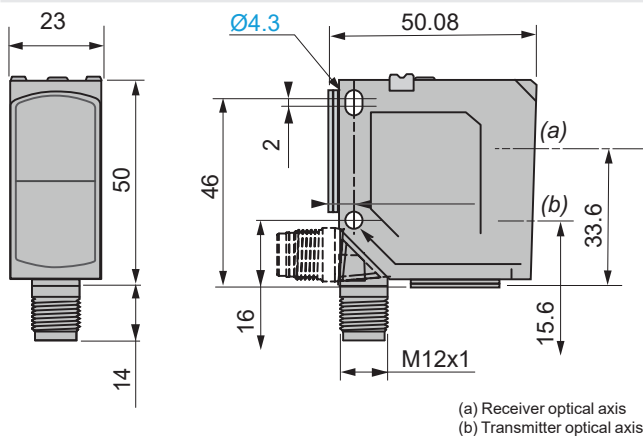

Photo-electric sensors

XU application, for accurate detection
Miniature and sub-miniature design, plastic



XUM5ALAYM8,
XUM8ALAYM8,
XUM9ALAYM8



XUT8ALAYP02,
XUT8ALAYL2,
XUT9ALXP02,
XUT9ALPXL2



XUM5ALAYP015,
XUM8ALAYP015,
XUM9ALAYP015



XUM5ALAYL2,
XUM8ALAYL2,
XUM9ALAYL2

Laser sensors

Max./operating sensing distance (Sn)	Function	Output	Connection	Reference	Weight kg
Diffuse mode detection IO-Link					
250 mm/150 mm	NO/NC configuration via teach-in or IO-Link	Autodetect PNP/NPN	Pre-cabled (L = 2 m)	XUM5ALAYL2	0 045
		Autodetect PNP/NPN	M8 connector (4-pin)	XUM5ALAYM8	0 018
		Autodetect PNP/NPN	Pigtail M12 (L = 0.15 m)	XUM5ALAYP015	0 026

BGS mode detection

BGS mode detection IO-Link					
150 mm/120 mm	NO/NC configuration via teach-in or IO-Link	Autodetect PNP/NPN	Pre-cabled (L = 2 m)	XUM8ALAYL2	0 056
		Autodetect PNP/NPN	M8 connector (4-pin)	XUM8ALAYM8	0 018
		Autodetect PNP/NPN	Pigtail M12 (L = 0.15 m)	XUM8ALAYP015	0 027
100 mm/70 mm	NO/NC configuration via teach-in or IO-Link	Autodetect PNP/NPN	Pre-cabled (L = 2 m)	XUT8ALAYL2	0 031
		Autodetect PNP/NPN	Pigtail M8 (L = 0.2 m)	XUT8ALAYP02	0 019

Reflex mode detection

15 m/13 m	NO/NC configuration via teach-in or IO-Link	Autodetect PNP/NPN	Pre-cabled (L = 2 m)	XUM9ALAYL2	0 056
		Autodetect PNP/NPN	M8 connector (4-pin)	XUM9ALAYM8	0 018
		Autodetect PNP/NPN	Pigtail M12 (L = 0.15 m)	XUM9ALAYP015	0 027

Reflex mode detection

Reflex mode detection IO-Link					
4 m/3 m	NO/NC configuration via teach-in	PNP	Pre-cabled (L = 2 m)	XUT9ALPXL2	0 031
		PNP	Pigtail M8 (L = 0.2 m)	XUT9ALXP02	0 019

Accessories

IO-Link Master (1)

See page 70 .

Fixing and other accessories

See page 74 .

Cabling accessories

See page 80 .

(1) Available 2nd quarter 2024.

Characteristics			
Sensor type		XUM●ALAY●●	
Product certifications		CE, UKCA, cULus, Ecolab	
Connection	Connector	M8	
	Pigtail for XUM5, XUM8, XUM9	m	Length = 0.15
	Pigtail for XUT8, XUT9	m	Length = 0.20
	Pre-cabled	m	Length = 2
Maximum sensing distance S _{max}	Diffuse mode	XUM5	mm 1 . 250
	Background suppression system	XUM8	mm 4 . 150
		XUT8	mm 6 . 70
	Reflex mode system	XU●9	mm 0.1 . .13
Detection light beam colour		Laser class 1, red	
Degree of protection	Conforming to IEC 60529	IP67 for XUM5, XUT8, XUM8, XUT9, XUM9	
	Conforming to DIN 40050-9	IP69K for XUM5, XUM8, XUM9	
Storage temperature		°C	-20 . +80
Operating temperature	XUM5, XUM8, XUM9	°C	-20 . +60
	XUT8, XUT9	°C	-20 . +50
Materials	Case for XUM5, XUM8, XUM9	ABS	
	Case for XUT8, XUT9	PUR	
	Lens	PMMA	
	Front	PMMA	
	Cable	PVC	
Rated supply voltage		V	12 . 24 ---
Voltage limits (including ripple)		V	10 . 30 ---
Current consumption, no-load	XUM5, XUM8, XUM9	mA	≤ 30
	XUT8, XUT9	mA	≤ 12
Switching capacity	XUM5, XUM8, XUM9	mA	≤ 100
	XUT8, XUT9	mA	≤ 50
Maximum switching frequency	XUM5, XUM9	Hz	4000
	XUT8, XUM8, XUT9	Hz	1000
Delays	First-up	ms	< 300
	Response	µs	≤ 125 for XUM5 125 for XUM9 500 for XUT8, XUT9 ≤ 500 for XUM8
	Recovery	ms	< 300

Photo-electric sensors

XU application, for accurate detection
Miniature and sub-miniature design, plastic

Wiring schemes

Laser sensors

M8/M12 connector - 4-pin - IO-Link

Pin	Signal	Definition
1	+	+ 24 V $\overline{\text{---}}$
2	IN	+ = NO - = NC Open = NO
3	-	0 V
4	Q	Switching signal (SIO)
	C	Communication (IO-Link)

Autodetect PNP/NPN or by IO-Link

XUM5ALAYM8, XUM5ALAYP015, XUM8ALAYM8, XUM8ALAYP015,
XUT8ALAYP02, XUM9ALAYM8, XUM9ALAYP015

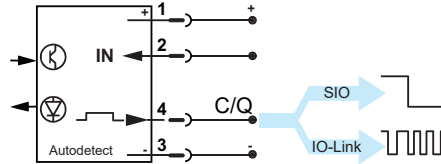

Note: IODD IO-Link files available on the website www.telemecaniquesensors.com/iolink

Pre-cabled - 4-wire - IO-Link

Pin	Signal	Definition
1	+	+ 24 V $\overline{\text{---}}$
2	IN	+ = NO - = NC Open = NO
3	-	0 V $\overline{\text{---}}$
4	C	Switching signal (SIO) Communication (IO-Link)

Autodetect PNP/NPN or by IO-Link

XUM5ALAYL2, XUM8ALAYL2, XUT8ALAYL2, XUM9ALAYL2

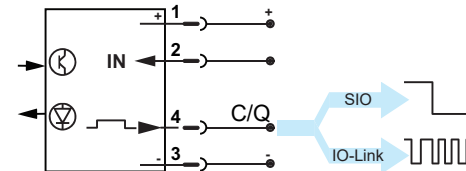

Note: IODD IO-Link files available on the website www.telemecaniquesensors.com/iolink

M8 connector - 4-pin

Pin	Signal	Definition
1	+	+ 24 V $\overline{\text{---}}$
2	IN	+ = NC - = NO Open = NO
3	-	0 V $\overline{\text{---}}$
4	Q	Switching signal

PNP

XUT9ALPXL2, XUT9ALPXP02

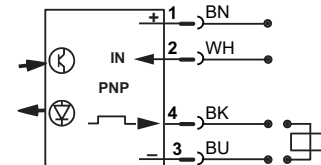

Note: IODD IO-Link files available on the website www.telemecaniquesensors.com/iolink

Dimensions

Miniature format: XUM

XUM●ALAYM8

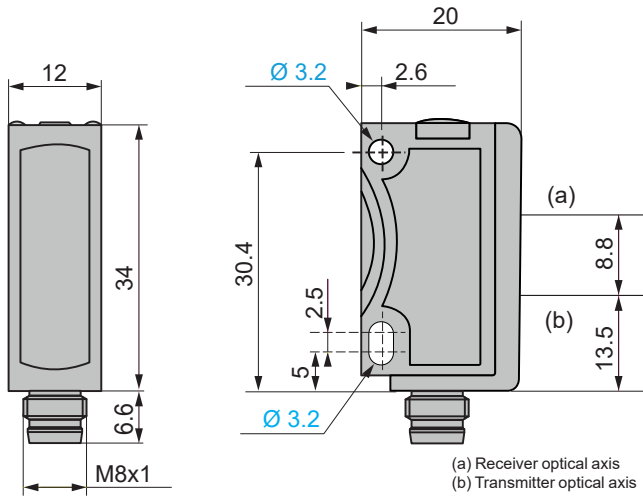

XUM●ALAYP015

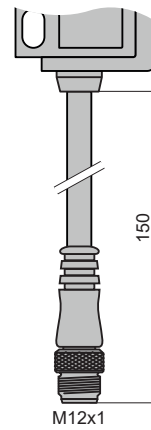

XUM●ALAYL2

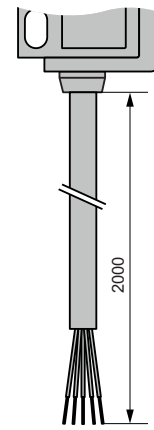

Sub-miniature format: XUT

XUT●●●●●●2

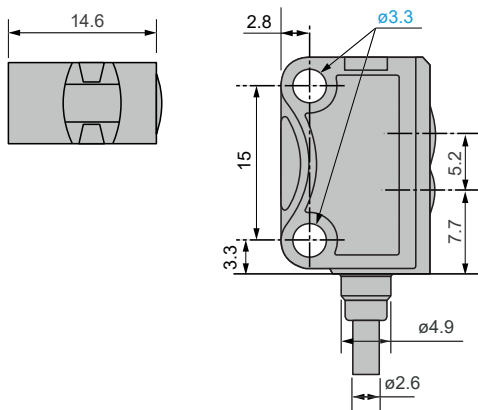

XUT●●●●●●P02

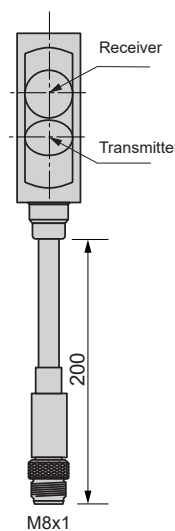

XUT●●●●●●L2

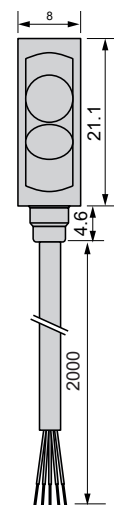

Detection curves

Laser sensor, diffuse mode detection

Light spot size: XUM5ALAY●●

Excess gain: XUM5ALAY●●

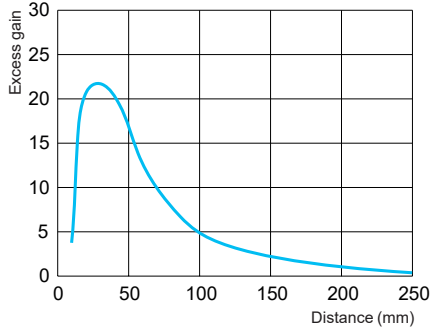
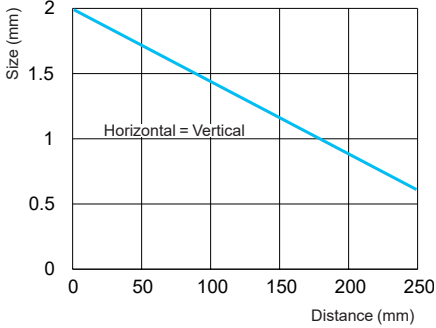

Laser sensor, reflex mode detection: XU●9AL●●

Functional reserves: XUM9ALAY●●

Light spot diameter: XUM9ALAY●●

Light spot size: XUT9ALPX●●

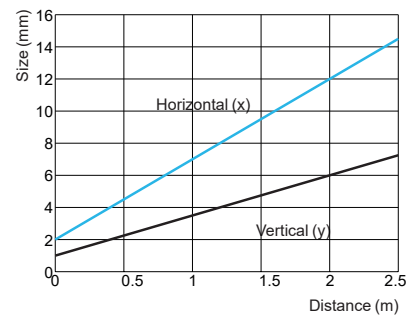
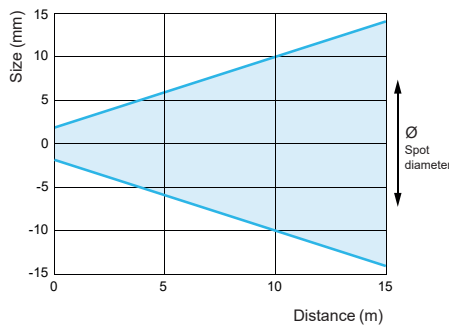
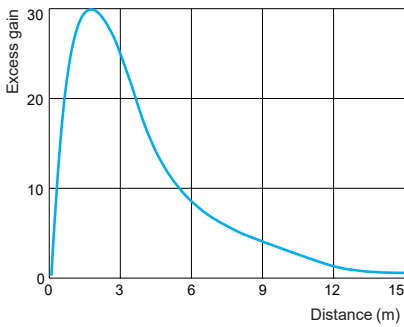

Detection curves

Laser sensor, background suppression mode

Light spot size: XUM8ALAY●●

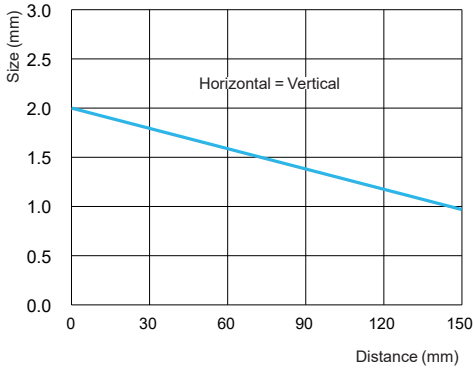

Light spot size: XUT8ALAY●●

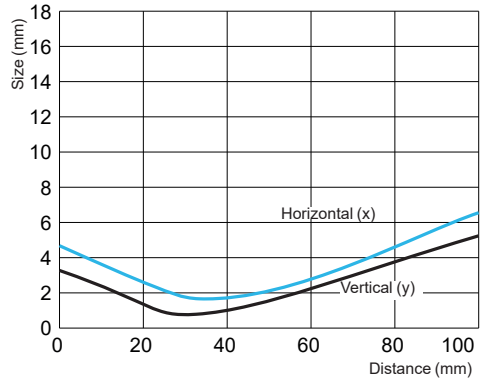

Scanning properties: XUM8ALAY●●

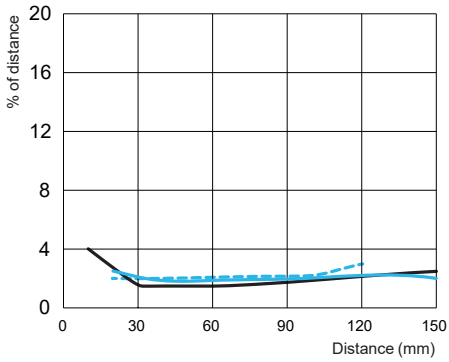

Scanning properties: XUT8ALAY●●

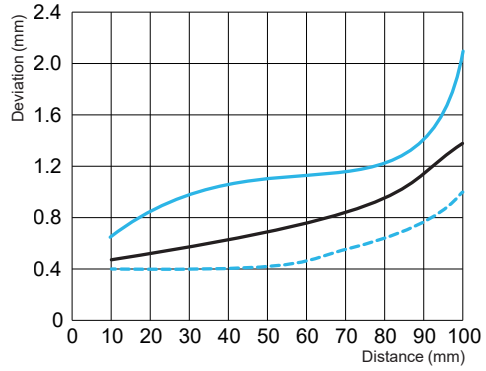

- Min .distance white object (90%)/white background (90%) (mm)
- Min .distance grey object (18%)/white background (90%) (mm)
- Min .distance black object (6%)/white background (90%) (mm)

Photo-electric sensors

XU application, for colour object detection
Compact and miniature design, plastic



XUKCBSAYM12



XUKCBLAYM12



XUMRACAYM8

Colour sensors IO-Link

Max./operating sensing distance (Sn)	Function	Output	Connection	Reference	Weight kg
--------------------------------------	----------	--------	------------	-----------	-----------

White light, multiple colour

60 mm/30 mm	NO/NC configuration	Autodetect PNP/NPN	M12 connector (3-output)	XUKCBSAYM12	0 017
150 mm/120 mm	via teach-in or IO-Link	Autodetect PNP/NPN	M12 connector (3-output)	XUKCBLAYM12	0 017

RGB light, unique colour

15 mm/12 mm	NO/NC configuration via teach-in or IO-Link	Autodetect PNP/NPN	M8 connector (4-pin)	XUMRACAYM8	0 018
-------------	---	--------------------	----------------------	------------	-------

Accessories

IO-Link Master (1)

See page 70 .

Fixing and other accessories

See page 74 .

Cabling accessories

See page 80 .

(1) Available 2nd quarter 2024.

Characteristics

Sensor type			XUKCB●AYM12	XUMRACAYM8
Product certifications			CE, UKCA, cULus	CE, UKCA, cULus, Ecolab
Connection	Connector		M12 (5-pin)	M8 (4-pin)
Maximum sensing distance Smax	White light	XUKC short	mm 60	–
		XUKC long	mm 150	–
	RGB light	XUMR	mm –	15
Detection light beam colour			White	Red, green and blue
Degree of protection	Conforming to IEC 60529		IP67	
	Conforming to DIN 40050-9		IP69K	
Storage temperature			°C -20 . +80	
Operating temperature			°C -20 . +55	
Materials	Case		Zinc die-cast	ABS
	Lens		PMMA	PMMA
	Front		PMMA	PMMA
	Cable			
Rated supply voltage			V 24 ---	12 . 24 ---
Voltage limits (including ripple)			V 18 . 30	10 . 30
Current consumption, no-load			mA ≤ 60	≤ 30
Switching capacity			mA ≤ 100	
Maximum switching frequency			Hz 3000	2500
Delays	First-up		ms 300	
	Response		µs ≤ 180	≤ 200
	Recovery		ms < 300	–

Wiring schemes

Colour detection system

M12 connector - 5-pin - IO-Link



Pin	Signal	Definition
1	+	+ 24 V $\overline{\text{DC}}$
2	IN	+ = NO - = NC Open = NO
3	-	0 V $\overline{\text{DC}}$
4	Q	Switching signal (SIO)
C		Communication (IO-Link)

Autodetect PNP/NPN or by IO-Link

XUKCB \bullet AYM12, XUMRACAYM8

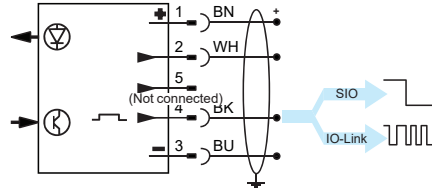

Note: IODD IO-Link files available on our website www.telemecaniquesensors.com/iolink

Detection curves

Colour detection system

Light spot size: XUKCBSAYM12 and XUKCBLAYM12

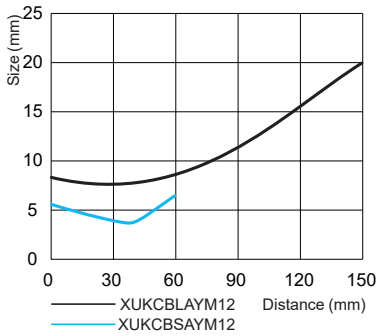

Signal process: XUMRACAYM8

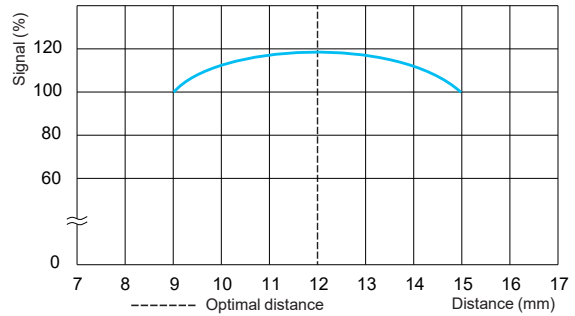

Dimensions

Compact format: XUKCB \bullet AYM12

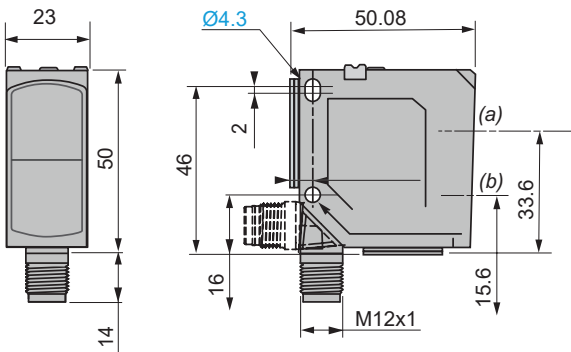

(a) Receiver optical axis
(b) Transmitter optical axis

Miniature format: XUMRACAYM8

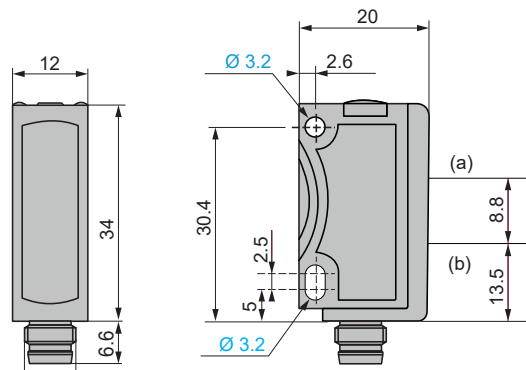

(a) Receiver optical axis
(b) Transmitter optical axis

Photo-electric sensors

XU application, for transparent object detection
Miniature, sub-miniature and compact design, plastic



XUMTARAYM8,
XUM7ABPXM8,
XUM8ABAYM8



XUMTARAYL2,
XUMTARAYP015,
XUM7ABPXL2,
XUM8ABAYP015



XUT8ABAYL2,
XUT8ABAYP02,
XUT7ABPXL2,
XUT7ABPXP02



XUK8ABPXM12

Sensors for transparent object detection

Max./operating sensing distance (Sn)	Function	Output	Connection	Reference	Weight kg
Polarised reflex system IO-Link					
2 m/2 m	NO/NC configuration via teach-in or IO-Link	Autodetect PNP/NPN	Pre-cabled (L = 2 m)	XUMTARAYL2	0 056
		Autodetect PNP/NPN	M8 connector (4-pin)	XUMTARAYM8	0 018
		Autodetect PNP/NPN	Pigtail M12 (L= 0.15 m)	XUMTARAYP015	0 027

BGS mode detection, adjustable IO-Link

200 mm/200 mm	NO/NC configuration via teach-in or IO-Link	Autodetect PNP/NPN	M8 connector (4-pin)	XUM8ABAYM8	0 014
		Autodetect PNP/NPN	Pigtail M12 (L= 0.15 m)	XUM8ABAYP015	0 027
100 mm/100 mm	NO/NC configuration via teach-in or IO-Link	Autodetect PNP/NPN	Pigtail M8 (L= 0.2 m)	XUT8ABAYP02	0 019
		Autodetect PNP/NPN	Pre-cabled (L = 2 m)	XUT8ABAYL2	0 031

BGS mode detection, not adjustable

100 mm/80 mm	NO/NC configuration via teach-in	PNP	Pre-cabled (L = 2 m)	XUM7ABPXL2	0 056
		PNP	M8 connector (4-pin)	XUM7ABPXM8	0 017
50 mm/50 mm	NO/NC configuration via teach-in	PNP	Pre-cabled (L = 2 m)	XUT7ABPXL2	0 031
		PNP	Pigtail M8 (L= 0.2 m)	XUT7ABPXP02	0 022

BGS mode detection, compact IO-Link

1200 mm/1200 mm	NO/NC configuration via teach-in or IO-Link	PNP	M12 connector (4-pin)	XUK8ABPXM12	0 046
-----------------	---	-----	-----------------------	--------------------	-------

Accessories

IO-Link Master (1)

See page 70 .

Fixing and other accessories

See page 74 .

Cabling accessories

See page 80 .

(1) Available 2nd quarter 2024.

Characteristics					
Sensor type		XUMTARAY●●	XU●7ABP●●	XUK8ABP●●	XU●8ABAY●●
Product certifications		CE, UKCA, cULus, Ecolab			
Connection	Connector	M8	M8 (for XUM7)	M12	M8
	Pigtail	Length = 0.15 m	Length = 0.2 m	–	L = 0.15 m (XUM8) L = 0.2 m (XUT8)
	Pre-cabled	Length = 2 m	Length = 2 m	–	Length = 2 m
Maximum sensing distance S_{max}	Polarised reflex system XUMTA	m	0.2	–	–
	BGS system, not adjustable XUM7	mm	–	0.80	–
	BGS system, adjustable XU●8	mm	–	–	White = 3.1200 Grey = 5.750 Black = 10.600
	BGS system, blue light XUT7	mm	–	2.50	–
Detection light beam colour		Red (LED)	Blue (LED)	Blue (LED)	Blue (LED)
Degree of protection	Conforming to IEC 60529	IP67			
	Conforming to DIN 40050-9	IP69K (except XUT)			
Storage temperature		°C	-20 . +80		
Operating temperature		°C	-20 . +60	-20 . +50	-20 . +60
Materials	Case	ABS	ABS for XUM7 PUR for XUT7	ABS/PC	ABS for XUM8 PUR for XUT8
	Lens	PMMA	PMMA	PMMA	PMMA
	Front	PMMA	PMMA	PMMA	PMMA
	Cable	PVC	PVC	–	PVC
Rated supply voltage		V	24 ---	12 . 24 ---	12 . 24 ---
Voltage limits (including ripple)		V	10 . 30		
Current consumption, no-load		mA	≤ 30	≤ 30 for XUM ≤ 20 for XUT	≤ 30
Switching capacity		mA	≤ 100	≤ 100 for XUM ≤ 50 for XUT	≤ 100
Maximum switching frequency		Hz	1000	1000	600
Delays	First-up	ms	< 300		
	Response	µs	500	830	500 for XUM 700 for XUT
	Recovery	ms	< 300		

Wiring schemes

Polarised reflex system

M8/M12 connector - 4-pin - or pre-cabled - 4-wire IO-Link

Pin	Signal	Definition
1	+	+ 24 V $\overline{\text{---}}$
2	IN	+ = NO - = NC Open = NO
3	-	0 V $\overline{\text{---}}$
4	Q	Switching signal (SIO)
	C	Communication (IO-Link)

PNP

XUMTARAYL2, XUMTARAYM8, XUMTARAYP015

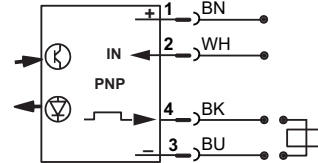

NPN

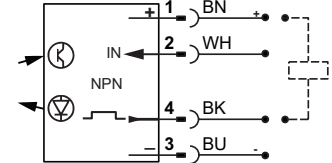

Note: IODD IO-Link files available on the website www.telemecaniquesensors.com/iolink

BGS mode detection, adjustable IO-Link

M8/M12 connector - 4-pin - or pre-cabled - 4-wire

Pin	Signal	Definition
1	+	+ 24 V $\overline{\text{---}}$
2	IN	+ = NO - = NC Open = NO
3	-	0 V $\overline{\text{---}}$
4	Q	Switching signal (SIO)
	C	Communication (IO-Link)

PNP

XUM8ABAYM8, XUM8ABAYP015, XUT8ABAYP02, XUT8ABAYL2

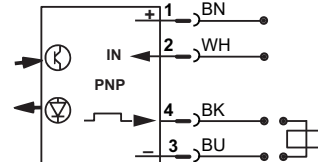

NPN

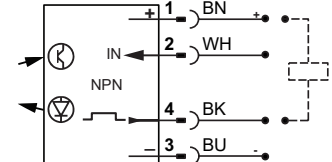

Note: IODD IO-Link files available on the website www.telemecaniquesensors.com/iolink

BGS mode detection, not adjustable

M8 connector - 4-pin - or pre-cabled - 4-wire

Pin	Signal	Definition
1	+	+ 24 V $\overline{\text{---}}$
2	IN	+ = NC - = NO Open = NO
3	-	0 V $\overline{\text{---}}$
4	Q	Switching signal

PNP

M8 connector

XUM7ABPXM8, XUT7ABPXP02

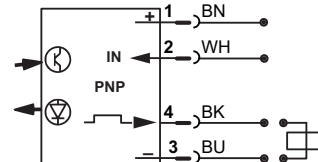

Pre-cabled

XUM7ABPXL2, XUT7ABPXL2

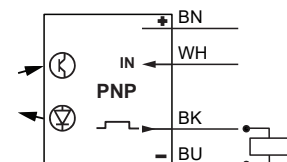

Note: IODD IO-Link files available on the website www.telemecaniquesensors.com/iolink

M12 connector - 4-pin

Pin	Signal	Definition
1	+	+ 24 V $\overline{\text{---}}$
2	IN	+ = NC - = NO Open = NO
3	-	0 V $\overline{\text{---}}$
4	Q	Switching signal

PNP

XUK8ABPXM12

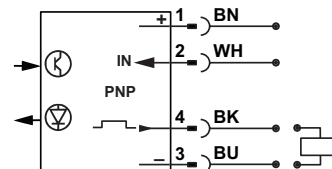

Note: IODD IO-Link files available on the website www.telemecaniquesensors.com/iolink

Dimensions

Miniature format: XUM

XUM●A●AYM8, XUM●A●AYL2, XUM●A●AYP015, XUM●ABPX●●

XUM●●●●●●●P015

XUM●●●●●●●L2

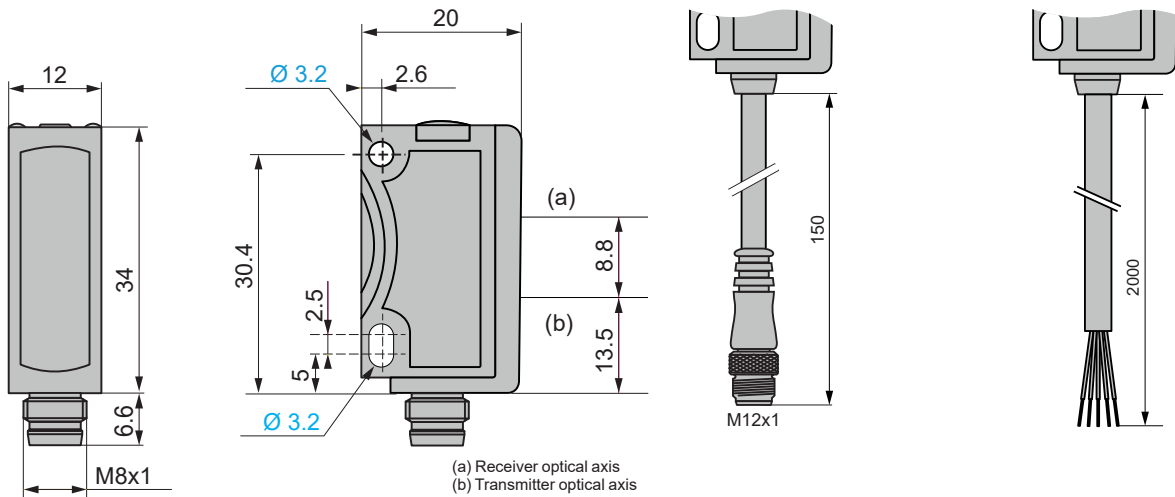

Sub-miniature format: XUT

XUT7ABXP02, XUT7ABPX2, XUT8ABAYL2, XUT8ABAYP02

XUT●●●●●●●P02

XUT●●●●●●●L2

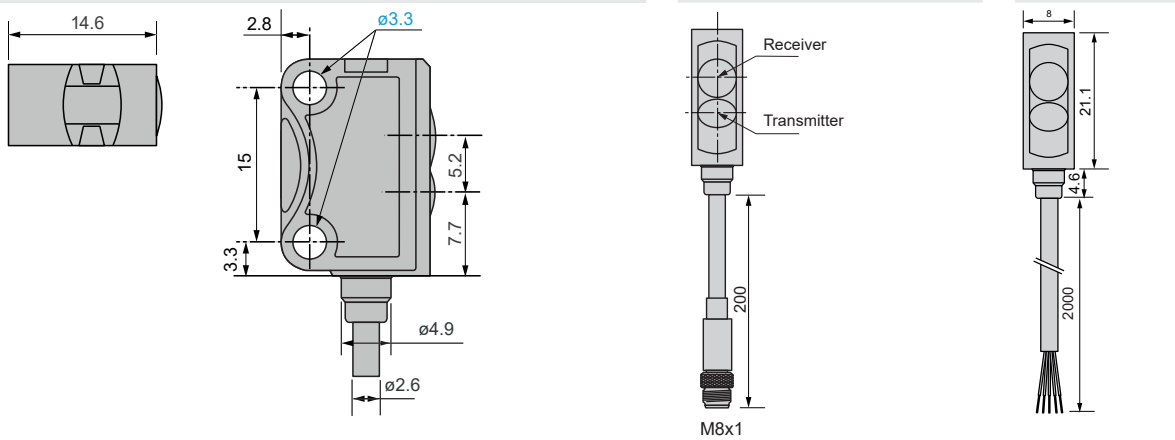

Compact format: XUK

XUK8ABPXM12

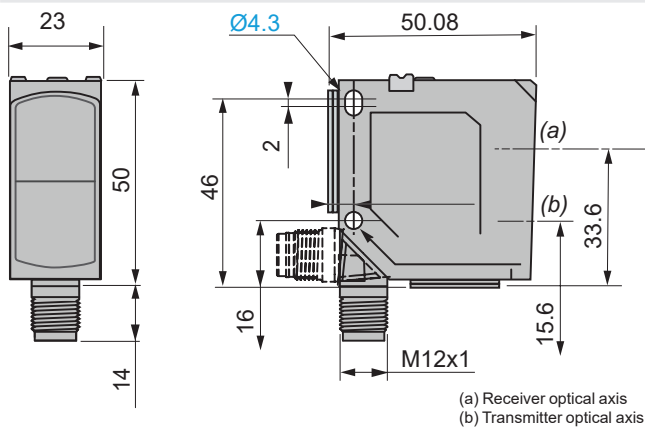

Detection curves

Polarised reflex

Light spot diameter: XUMTARAY●●

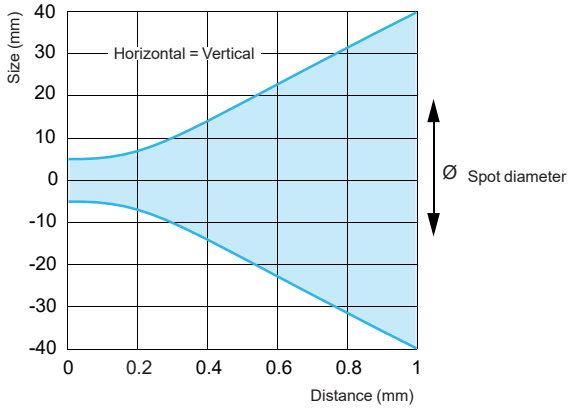

Background suppression mode

Light spot diameter: XUK8ABPXM12

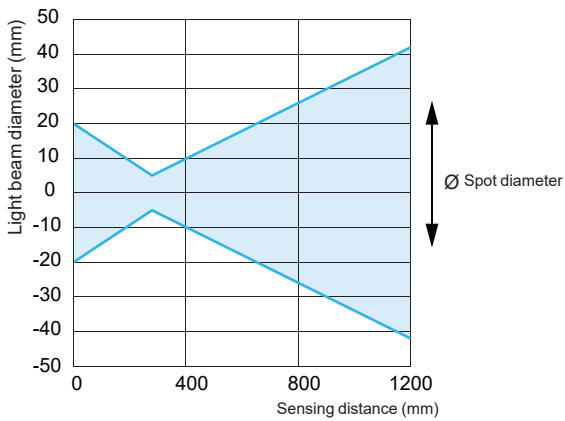

Detection curves

Background suppression mode

Scanning properties: XUT8ABAY●●

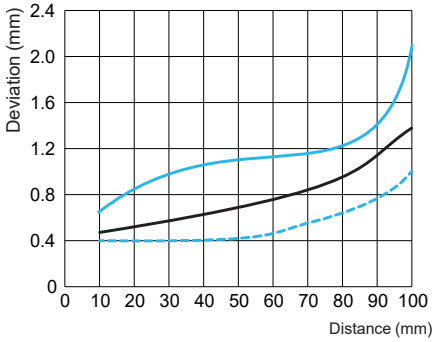

Scanning properties: XUK8ABPXM12

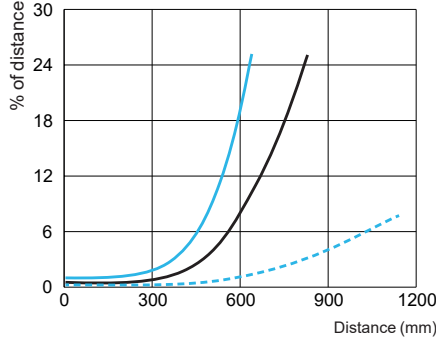

Scanning properties: XUM8ABAY●●

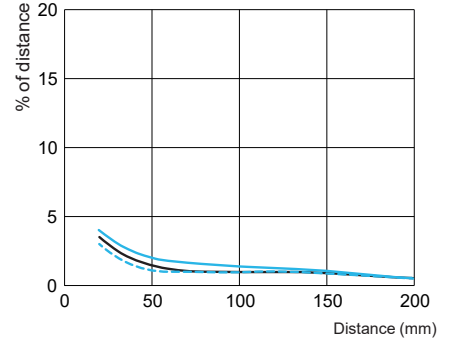

--- Min .distance white object (90%)/white background (90%) (mm)
--- Min .distance grey object (18%)/white background (90%) (mm)
--- Min .distance black object (6%)/white background (90%) (mm)

Light spot size: XUM7ABPX●●

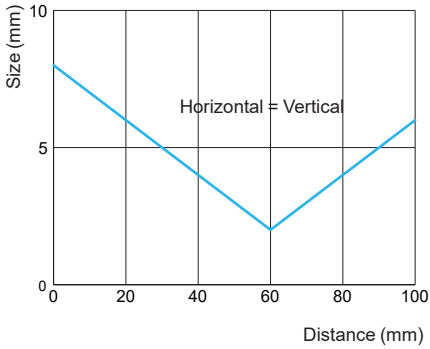

Light spot size: XUT7ABPX●●

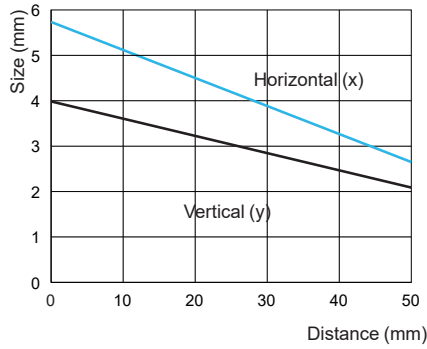

Light spot size: XUT8ABAY●●

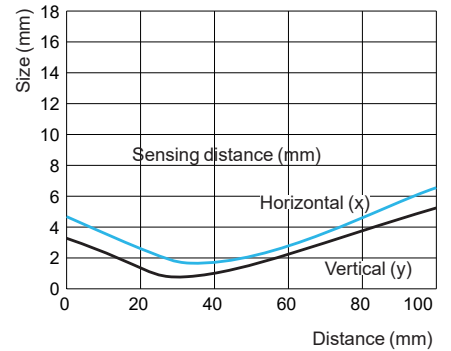

IO-Link



XZIO8AM12PY

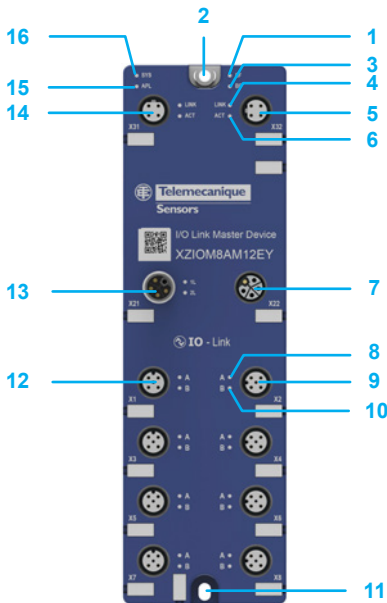

- 1 For Ethernet, module status LED (MS)
For PROFINET, system error LED (SF)
- 2 Fixing hole and functional earth (FE)
- 3 For Ethernet, network status LED (NS)
For PROFINET, bus failure LED (BF)
- 4 Link LED X32
- 5 Ethernet interface, M12, D-coded, port 2
- 6 Activity LED X32
- 7 Power Out
- 8 IO-Link status LED, port 2, channel A
- 9 IO-Link, port 2, M12, A-coded
- 10 IO-Link status LED, port 2, channel B
- 11 Fixing hole
- 12 IO-Link, port 1, M12, A-coded
- 13 Power In
- 14 Ethernet interface, M12, D-coded, port 1
- 15 Application status LED
- 16 System status LED

Presentation

IO-Link is a point-to-point network communication protocol dedicated to sensors and actuators offering advantages such as increased productivity, simplified integration and reduced inventory .

It enables:

- Simplified connection of sensors and actuators to the upper-level control and monitoring system of an automated line
- Advanced diagnostic functions, through continuous monitoring of critical parameters such as signal quality and sensor status
- Reduced commissioning time due to fewer cables and hot swappable devices
- Integration with third-party devices, thanks to multiple fieldbus protocol support (PROFINET, Ethernet/IP)

Telemecanique Sensors offers a wide choice of IO-Link conformant devices, with various detection systems such as thru-beam, diffuse, polarised reflex, etc.

IO-Link system

An IO-Link system consists of the following components:

- IO-Link Master
- IO-Link devices (sensors, RFID readers, valves, motor starters, I/O modules)
- Cabling
- Engineering tool for integration and configuration of IO-Link devices (Simply Config IO-Link Master software (2))

Description

IO-Link Masters

IO-Link Masters serve to capture digital inputs and outputs being conveyed between the PLC and the IO-Link devices .

Two types of IO-Link Master are available:

- **XZIO8AM12EY** Ethernet Master, for devices connected to an Ethernet/IP network
- **XZIO8AM12PY** PROFINET Master, for devices connected to a PROFINET network

An IO-Link Master enables:

- On the sensor side: IODD file management, sensor configuration, port diagnosis
- On the Master side: Master configuration, firmware update, factory reset, Master diagnosis, MQTT setting

Example of installation in line or star topology

Line topology

Ethernet/IP-Scanner/
PROFINET I/O controller

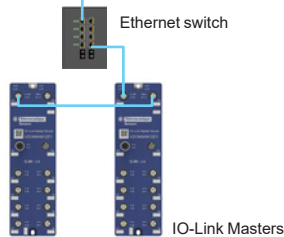

Star topology

Ethernet/IP-Scanner/
PROFINET I/O controller

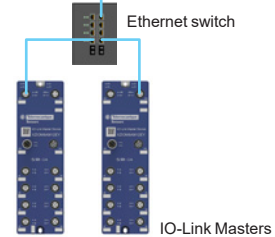

(1) Available 2nd quarter 2024.

(2) Simply Config IO-Link software can be downloaded from [our website](#).

IO-Link Master devices

Description	Protocol	Power consumption	Number of ports	Connector	Reference	Weight kg
IO-Link Master	Ethernet/IP	24V $\overline{\text{---}}$	8 class A	M12	XZIOM8AM12EY	0 405
	PROFINET	24V $\overline{\text{---}}$	8 class A	M12	XZIOM8AM12PY	0 405

IO-Link power cables

Description	Type of connector	End fittings	Length m		Reference	Weight kg
Single-ended, pre-wired, L-coded power cable (PUR)	Female	5-pin (4+FE)	2	1 5 mm ²	XZCPK75DL2	0 255
			5	1 5 mm ²	XZCPK75DL5	0 585
			2	1 5 mm ²	XZCPK75CL2	0 255
			5	1 5 mm ²	XZCPK75CL5	0 585
			Jumper power cable (PUR)	Male/ Female	M12 5-pin/M12 5-pin	2
			5	1 5 mm ²	XZCR25K25DL5	0 615
			2	1 5 mm ²	XZCR26K26CL2	0 285
			5	1 5 mm ²	XZCR26K26CL5	0 615



XZCPK75●L

XZCR26K26●L

Dimensions

XZIOM8AM12●Y

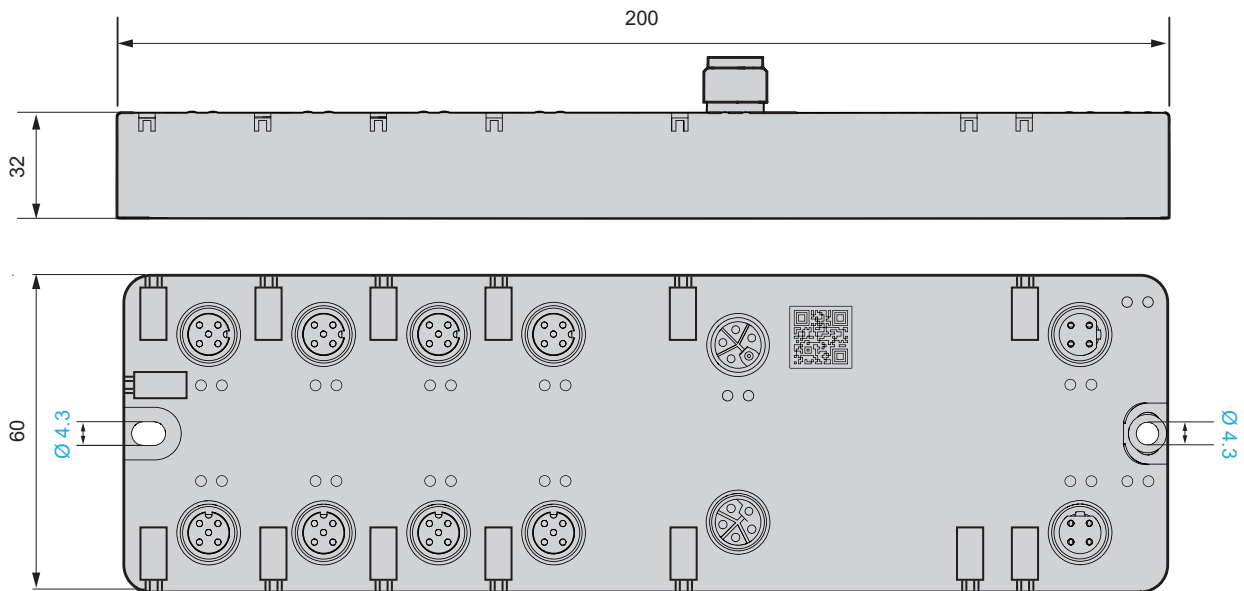

Product specifications					
Reference		XZIOM8AM12EY		XZIOM8AM12PY	
Function		Ethernet/IP IO-Link Master		ProfiNet IO-Link Master	
Power supply 1L, 2L	Supply voltage 1L, 2L	V	24, -25%/+30% (18...31.2)		
	Low voltage warning 1L	V	18.0 (± 5% at 25 °C) notification on, 18.3 (± 5% at 25 °C) notification off		
	Overvoltage warning 1L	V	30.0 (± 5% at 25 °C) notification on, 29.7 (± 5% at 25 °C) notification off		
	Current consumption	A	1L: 0.1 . 16 (at 24 V DC) 2L: 0.01 . 16 (at 24 V DC)		
	Current consumption of supply port	A	Max. 16		
	Conductor cross-section	mm²	0.5...2.5		
	Connector		PWR IN: M12 L-coded, 5-pin, plug PWR OUT: M12 L-coded, 5-pin, socket		
	Torque	Nm	1.0		
	Reverse polarity protection		Yes		
	Power supply	V	24 --- PELV (Protective Extra Low Voltage) or SELV (Safety Extra Low Voltage)		
Total load	Maximum total load current	A	15.7		
Device	Dimensions (L x W x H)	mm	200 x 60 x 32		
	Weight	g	404		
	Housing		Plastic		
	Potting		Solvent-free electro-casting resin system based on 2 K polyurethane		
	Degree of protection		IP67 (EN 60529)		
	Protection class		III (EN 61140)		
	Mounting		Screw mounting on carrier, 2x M4		
Environmental conditions	Location of operation		Indoor		
	Ambient temperature (operation)	°C	-25 . +70		
	Ambient temperature (storage)	°C	-40 . +80		
	Maximum temperature change	K/min	3		
	Relative humidity		5% . 95%		
	Degree of pollution		3 (EN 60664-1)		
	Altitude	m	0...2000		
	Overvoltage category		II (EN 60664-1)		
	Degree of protection		IP67 (EN 60529)		
	Protection class		III (EN 61140)		
Electrical characteristics	Insulation resistance	V	60 ---		
	Test voltage	V	550 ~ RMS		
	Minimal creepage distance	mm	0.7		
Ethernet connector	Communication interface		Ethernet		
	Autonegotiation, autocrossover		Yes		
	Connector		2x M12, D-coded, socket, 4-pin		
	Torque	Nm	1.0		
IO-Link connector	Connector		8x M12, A-coded, plug, 5-pin		
	Torque	Nm	1.0		
	Operating modes		Pin 2: DI or DO Pin 4: IO-Link Master, DI or DO		
LEDs	SYS		System status, green/yellow		
	APL		Application status, red/green		
	MS		Module status (EtherNet/IP), red/green		-
	SF		-		System error (PROFINET), red
	NS		Network status (EtherNet/IP), red/green		-
	BF		-		Bus error (PROFINET), red
	LINK		Link status, green		
	ACT		Activity status, yellow		
	1L, 2L		Supply voltage status, red/green		
	A, B		Port status: red/green/yellow (yellow by simultaneous red and green)		
Compliance	RoHS		Yes		
Compliance with EMC guidelines	CE sign		Yes		
	UKCA sign		Yes		
	Emission		EN 61000-6-4/BS EN 61000-6-4		
	Immunity		EN 61000-6-2/BS EN 61000-6-2		

Wiring schemes

Power supply

M12 connector - 5 pins (4 + FE) - IO-Link

Supply voltage input

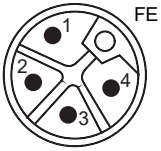

Supply voltage input

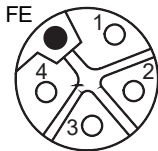

Pin	Signal	Wire colour	Description
1	1L+	Brown	24 V $\overline{\text{DC}}$
2	2L-	White	Reference potential for 2L
3	1L-	Blue	Reference potential for 1L
4	2L+	Black	24 V $\overline{\text{DC}}$ auxiliary/control voltage U2L
FE	FE	Pink	Functional earth

Communication

M12 connector - D-coded - socket - 4 pins

Ethernet

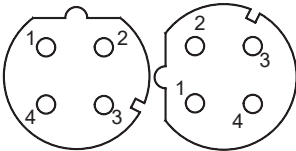

Pin	Signal	Wire colour	Description
1	TX+	Brown	Transmit data positive
2	RX+	White	Receive data positive
3	TX-	Blue	Transmit data negative
4	RX-	Black	Receive data negative

IO-Link ports (Class A)

M12 connector - 4 pins

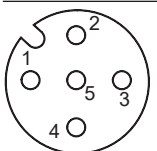

Pin	Signal	Wire colour	Description
1	+	Brown	+24 V DC supply voltage U 1L for sensor/actuator
2	IN	White	Digital input/output channel B
3	-	Blue	Functional earth for 1L+
4	Q	Black	IO-Link data or Digital input/output channel A
5	-	-	Not connected

Auto-detect PNP/NPN or by IO-Link IO-Link

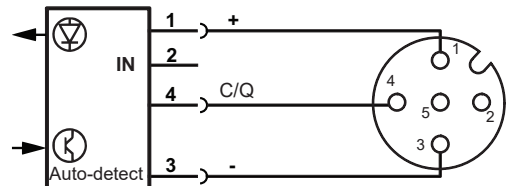

Derating curves

XZIOM8AM12EY and XZIOM8AM12PY

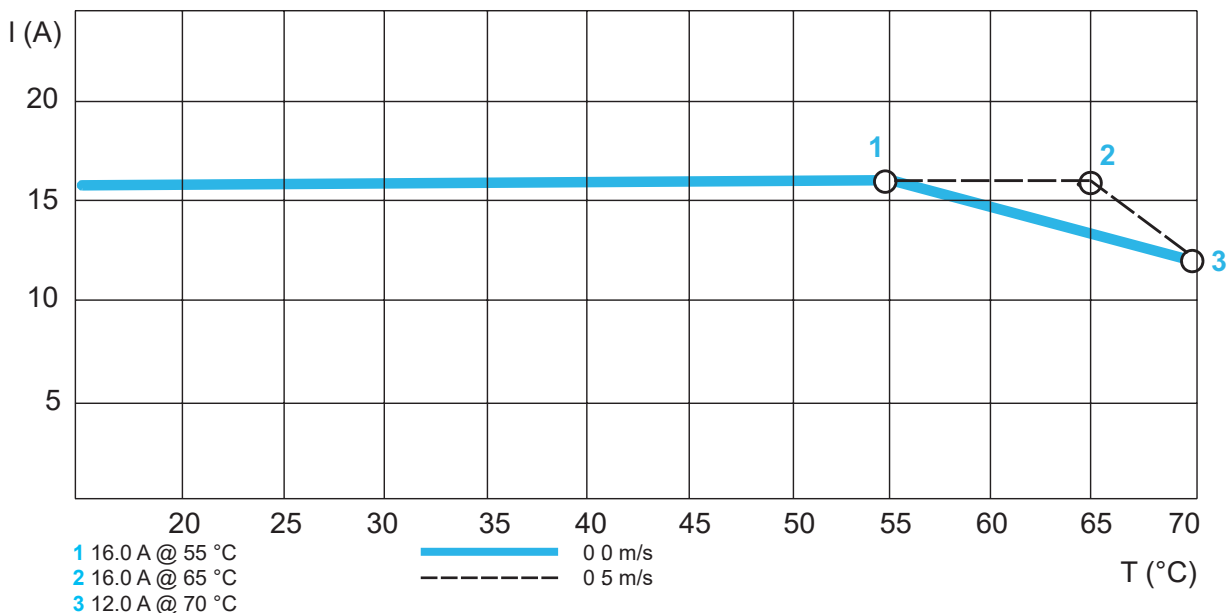

Photo-electric sensors

XU general purpose, single mode function

Accessories

Fixing brackets



XUZASM02 XUZASM03 XUZASM04



XUZASN001 XUZASN002 XUZA50



XUZA51S XUZASK001



XUZASW001 XUZASW002



XUZA118 XUZA218



XUZARS XU_ZASS



XUZARM XU_ZARK



XUZASB001 XUZASB002 XU_ZASB003

Fixing accessories

Fixing brackets

Description	For use with sensors	Reference	Weight kg
Wrap-around horizontal mounting bracket for pre-cabled sensors Supplied with 2 x M3 screws	XUM●A●XBL2	XUZASM02	0 030
Wrap-around vertical mounting bracket for pre-cabled sensors Supplied with 2 x M3 screws	XUM●A●XBL2	XUZASM03	0 062
Rear mounting bracket Supplied with 2 x M3 screws	XUM●A●XBL2, XUM●A●XBM8	XUZASM04	0 030
Stainless steel grade 316 fixing bracket Supplied with 2 x M3 screws	XUN	XUZASN001	0 124
Wrap-around vertical mounting bracket for pre-cabled sensors Supplied with 2 x M3 screws	XUN	XUZASN002	0 133
Metal fixing bracket Supplied with 2 x M3 screws	XUM, XUT, XUK	XUZA50	0 025
Stainless steel grade 316 fixing brackets Supplied with 2 x M3 screws	XUK8ABPXM12	XUZA51S	0 050
Stainless steel grade 304 fixing bracket for compact sensor 50 x 50 mm Supplied with 2 x M3 screws	XUK8ABPXM12	XUZASK001	0 240
Metal dovetail fixing clamp, 1 axis Supplied with 1 x M3 screw	XUK8ABPXM12	XUZASW001	0 014
Simple metal fixing bracket Supplied with 2 x M3 screws	XUK8ABPXM12	XUZASW002	0 017
90° stainless steel fixing brackets	XUB	XUZA118	0 045
Plastic fixing bracket with adjustable ball joint	XUB	XUZA218	0 035
Dovetail clamp Supplied with 2 x M3 screws	XUT7ABPX●●, XUT8A●AY●●, XUT9ABPX●●	XUZARS	0 005
Mounting bracket Supplied with 2 x M3 screws	XUT7ABPX●●, XUT8A●AY●●, XUT9ABPX●●	XUZASS	0 008
Dovetail clamp Supplied with 2 x M3 screws	XUM●A●AYM8, XUM●A●AYP015, XUM●A●AYL2, XUM7ABPX●●	XUZARM	0 017
Dovetail clamp Supplied with 1 x M3 screw	XUKCB●AYM12, XUK8ABPXM12	XUZARK	0 026

Mounting rings

Description	For use with sensors	Reference	Weight kg
Stainless steel flush mounting nut	XUB	XUZASB001	0 018
Plastic mounting ring 27 mm x 16.8 mm	XUB	XUZASB002	0 003
Metal mounting ring 30 mm x 18 mm	XUB	XUZASB003	0 011

Cabling accessories

See pages 80 to 85 .

Fixing accessories

Fixing brackets

XUZASM04

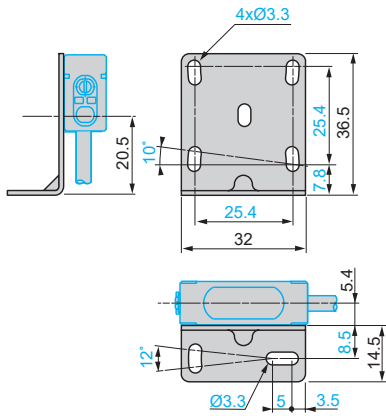

XUZASM03

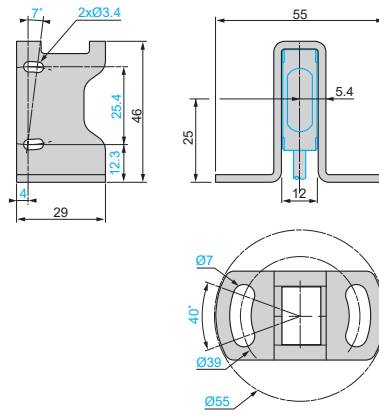

XUZASM02

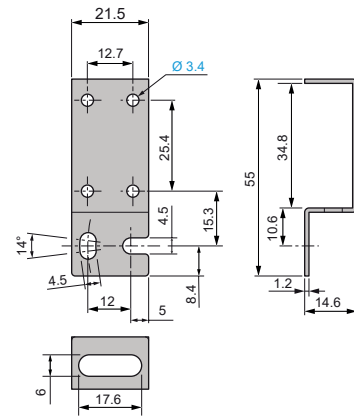

XUZASN001

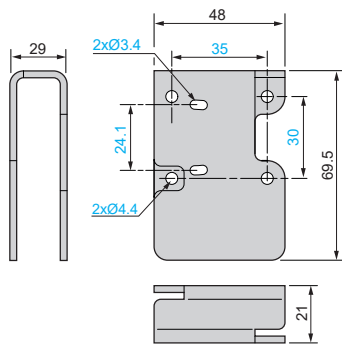

XUZASN002

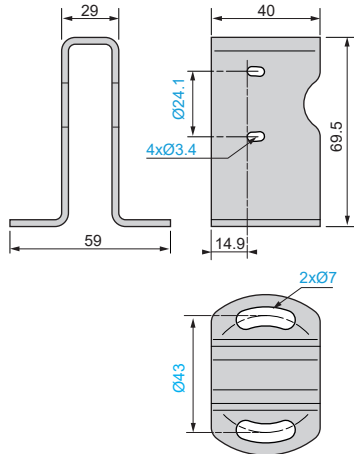

XUZA50

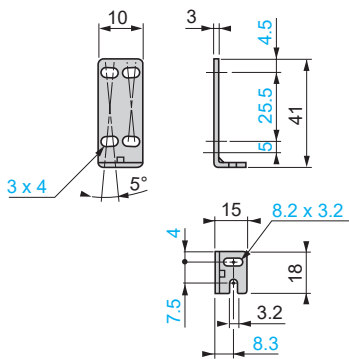

Fixing accessories

Fixing brackets

XUZA51S

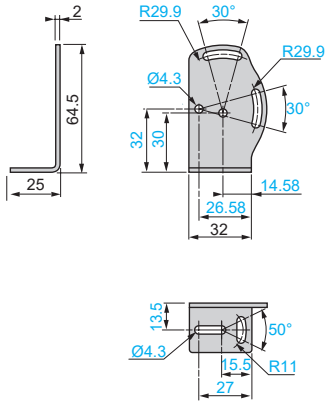

XUZASK001

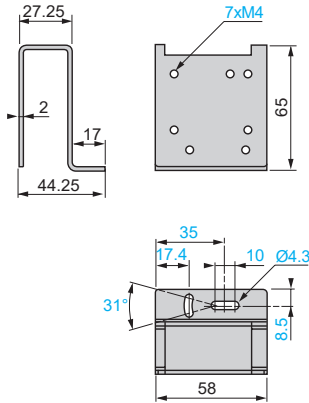

XUZASW001

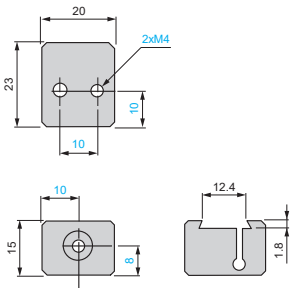

XUZASW002

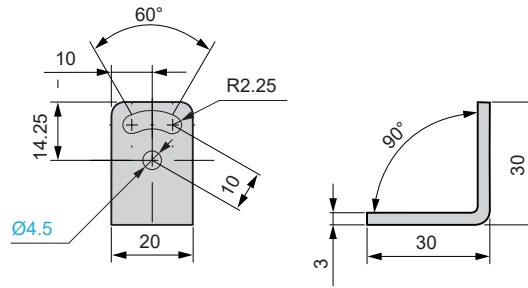

XUZA118

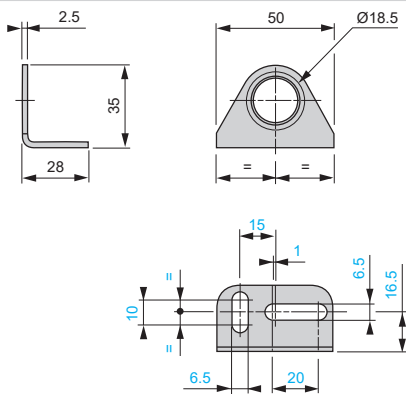

XUZA218

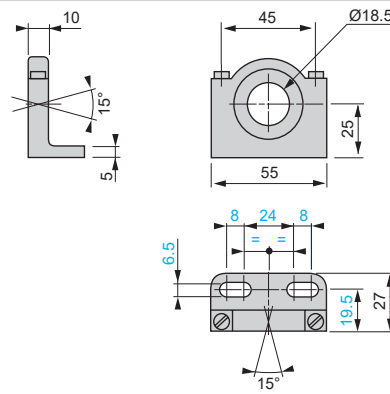

Fixing accessories

Fixing brackets

XUZARS

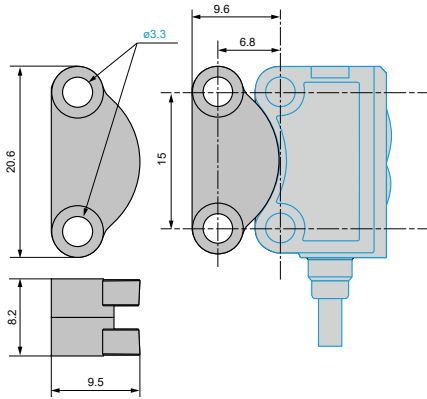

XUZASS

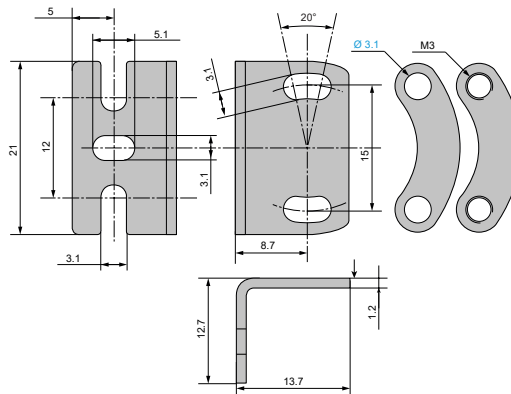

XUZARM

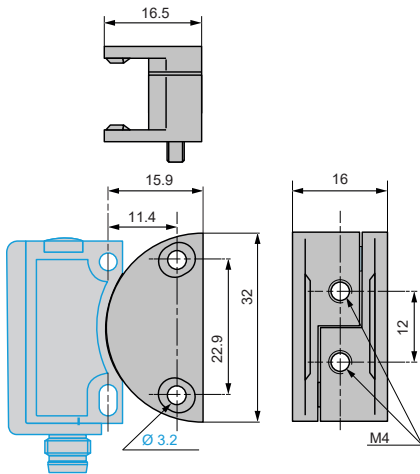

XUZARK

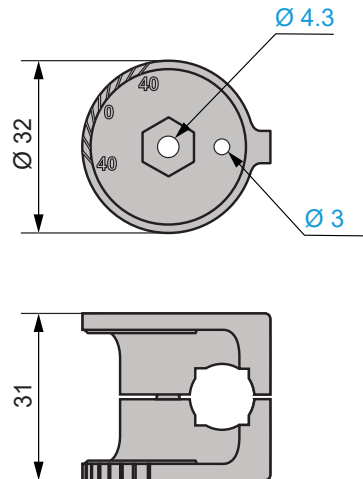

Mounting rings

XUZASB001

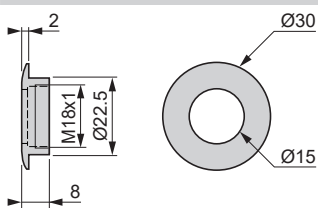

XUZASB002

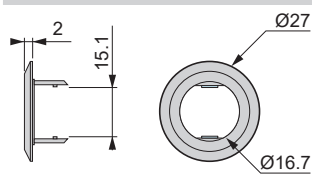

XUZASB003

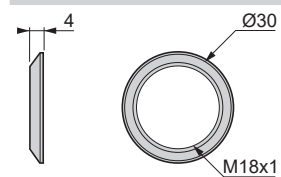

Photo-electric sensors

XU general purpose, single mode function

Accessories

Reflectors



XUZC50_30

XUZC50



XU_511_FFJR18019

XUZC60S11



XU_511_FFJR18005

XUZC39

Reflectors

References

Description	Size	Fixing mode	Reference	Weight kg
Rigid square reflectors	100 mm x 100 mm	2 brackets (not provided)	XUZC100	0 035
	51.5 mm x 69 mm	6 holes	XUZC50	0 020
Rigid rectangle reflectors	45 mm x 29 mm	2 holes	XUZC24	0 010
	40 mm x 60 mm	2 holes	XUZC60S11	0 022
Rigid circular reflectors	Ø 39 mm	Adhesive	XUZC39	0 008

Cabling accessories

See pages 80 to 85 .

Reflectors

Dimensions

XUZC100

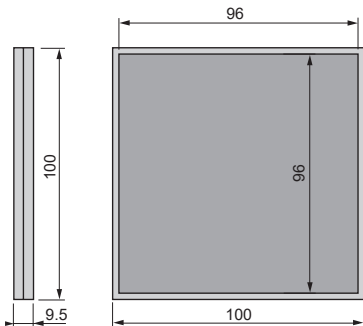

XUZC50

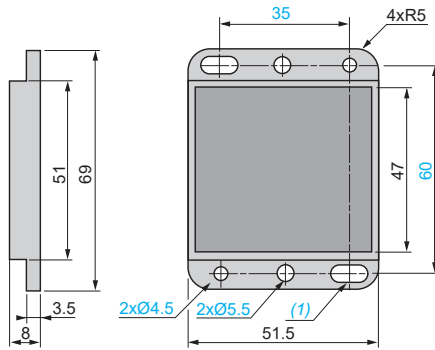

XUZC24

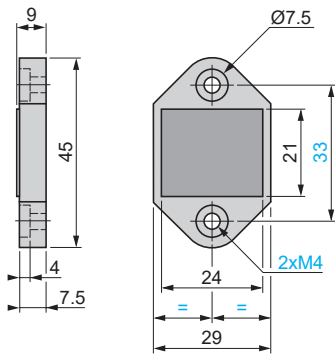

XUZC60S11

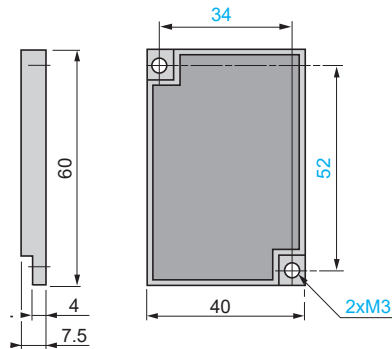

XUZC39

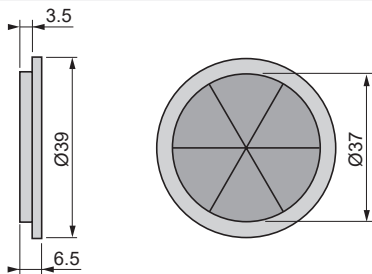

(1) 2 elongated holes Ø 4.5 x 8

Note: All reflectors are IP 67 and IP 69K.

Photo-electric sensors

Cables for sensors

Pre-wired connectors

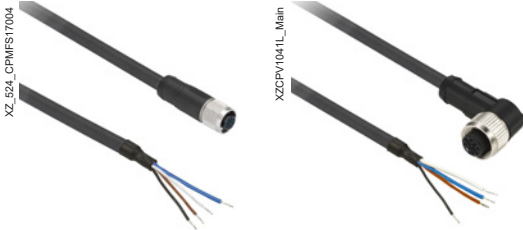

Pre-wired M8 connector, 4 conductors

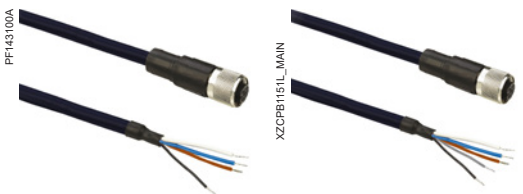

Pre-wired M12 connector, straight, 4 conductors (left) and 5 conductors (right)

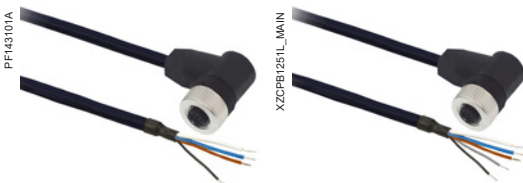

Pre-wired M12 connector, elbowed, 4 conductors (left) and 5 conductors (right)

PVC cables with pre-wired connector

Description	Connector type	End fittings	Length (m)	For use with sensor	Reference	Weight kg
M8 connector						
Pre-wired M8 connectors	Female, straight	4-pin	2	XUM●●●●M8,	XZCPV0941L2	0 090
			5	XUT●●●●M8	XZCPV0941L5	0 200
			10		XZCPV0941L10	0 380
	Female, elbowed	2			XZCPV1041L2	0 090
			5		XZCPV1041L5	0 200
			10		XZCPV1041L10	0 380

M12 connector

Pre-wired M12 connectors	Female, straight	4-pin	2	XUM●●●●M12,	XZCPV1141L2	0 090
			5	XUM●●●●P015,	XZCPV1141L5	0 200
			10	XUN●●●●M12,	XZCPV1141L10	0 380
	Female, elbowed	2		XUB●●●●M12,	XZCPV1241L2	0 090
			5	XUT●●●●M12	XZCPV1241L5	0 200
			10		XZCPV1241L10	0 380

PUR cables with pre-wired connector

Description	Connector type	End fittings	Length (m)	For use with sensor	Reference	Weight kg
M8 connector						
Pre-wired M8 connectors	Female, straight	4-pin	2	XUM●●●●M8,	XZCP0941L2	0 080
			5	XUT●●●●M8	XZCP0941L5	0 180
			10		XZCP0941L10	0 360
	Female, elbowed	2			XZCP1041L2	0 080
			5		XZCP1041L5	0 180
			10		XZCP1041L10	0 360

M12 connector

Pre-wired M12 connectors	Female, straight	4-pin	2	XUM●●●●M12,	XZCP1141L2	0 090
			5	XUM●●●●P0●,	XZCP1141L5	0 190
			10	XUN●●●●M12,	XZCP1141L10	0 370
	Female, elbowed	2		XUB●●●●M12,	XZCP1241L2	0 090
			5	XUK●●●●M12	XZCP1241L5	0 190
			10		XZCP1241L10	0 370

M12 connector, shielded

Shielded pre-wired connectors M12	Female, straight	4-pin	2	XUM●●●●M12,	XZCPB1141L2	0 200
			5	XUM●●●●P0●,	XZCPB1141L5	0 350
				XUN●●●●M12,		
	Female, elbowed	2		XUB●●●●M12,		
			5	XUK●●●●M12		
			5-pin	2	XUKC●●●●	XZCPB1151L2
	5		XZCPB1151L5	0 259		
	2		XZCPB1251L2	0 113		
	5		XZCPB1251L5	0 258		



Jumper cables, M12-M12 connectors, 4-pin/4-pin



Shielded jumper cables, M12-M12 connectors, 5-pin/5-pin



Jumper cables, M8-M8 connectors, 3-pin/3-pin



Jumper cables, M8-M8 connectors, 3-pin/4-pin



Jumper cables, M8-M12 connectors, 3-pin/5-pin

PVC jumper cables

Description	Connector type		End fittings	Length (m)	For use with sensor	Reference	Weight kg
	Male	Female					
M12-M12 connectors							
PVC jumper cable XZ	M12, straight	M12, straight	4-pin/4-pin	1	XUM●●●●M12,	XZCRV1511041C1	0 070
				2	XUM●●●●P015,	XZCRV1511041C2	0 110
				5	XUN●●●●M12,	XZCRV1511041C5	0 230
	M12, elbowed			1	XUT●●●●M12	XZCRV1512041C1	0 070
				2		XZCRV1512041C2	0 110
				5		XZCRV1512041C5	0 230

PUR jumper cables

Description	Connector type		End fittings	Length (m)	For use with sensor	Reference	Weight kg
	Male	Female					
Shielded, M12-M12 connectors							
PUR jumper cable XZ	M12, straight	M12, straight	5-pin/5-pin	2	XUCK●●●●	XZCRB151151C2	0 123
				5		XZCRB151151C5	0 267

M8-M8 connectors

PUR jumper cable XZ	M8, straight	M8, straight	3-pin/3-pin	1	XUM●●●●M8,	XZCR2705037R1	0 065
				2	XUT●●●●M8	XZCR2705037R2	0 090
				M8, elbowed	1		XZCR2706037R1

PUR jumper cable XZ	M8, straight	M8, straight	3-pin/4-pin	2	XUM●●●●M8,	XZCR2709037S2	0 090
					XUT●●●●M8	XZCR2710037S1	0 065
				M8, elbowed	2		XZCR2710037S2

M8-M12 connectors

PUR jumper cable XZ	M8, straight	M12, straight	3-pin/5-pin	1	XUM●●●●M8,	XZCR2711037T1	0 065
				2	XUT●●●●M8	XZCR2711037T2	0 093
	M12, elbowed			1		XZCR2712037T1	0 065
				2		XZCR2712037T2	0 093

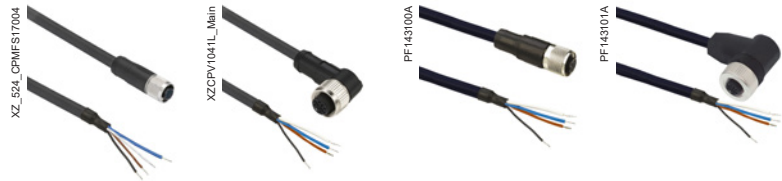

Connector type	Female, M8, straight	Female, M8, elbowed	Female, M12, straight	Female, M12, elbowed	
Number of conductors	4				
References					
PVC cable	L = 2 m	XZCPV0941L2	XZCPV1041L2	XZCPV1141L2	XZCPV1241L2
	L = 5 m	XZCPV0941L5	XZCPV1041L5	XZCPV1141L5	XZCPV1241L5
	L = 10 m	XZCPV0941L10	XZCPV1041L10	XZCPV1141L10	XZCPV1241L10
Weight (kg)	0 090 (L = 2 m) 0 200 (L = 5 m) 0 380 (L = 10 m)				
Characteristics					
Certifications	cULus				
Connection type	Screw threaded (metal clamping ring)				
Cable material	Sheath	PVC			
	Conductor insulation	PP			
Degree of protection	IP65, IP67				
Ambient air temperature	Static cable	-25...+80 °C			
	Flexing cable	-5...+80 °C			
Conductor c.s.a	4 x 0.25 mm ²				
Cable diameter	4.6 mm				
Nominal voltage	60 V ~, 75 V ~		250 V ~, 300 V ~		
Nominal current	3 A				
Insulation resistance	> 10 ⁹ Ω				
Contact resistance	≤ 5 m Ω				

Connections

XZCPV0941L●,
XZCPV1041L●

XZCPV1141L●,
XZCPV1241L●

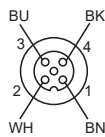
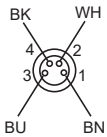

BN: Brown
WH: White
BU: Blue
BK: Black

Dimensions

XZCPV0941L●

XZCPV1041L●

XZCPV1141L●

XZCPV1241L●

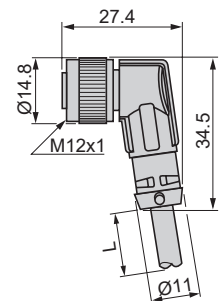
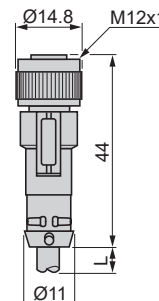
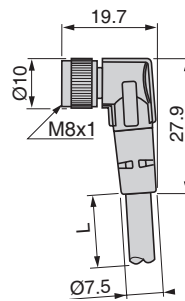
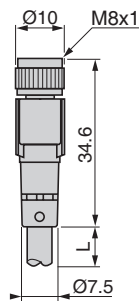

L = 2, 5 or 10 m

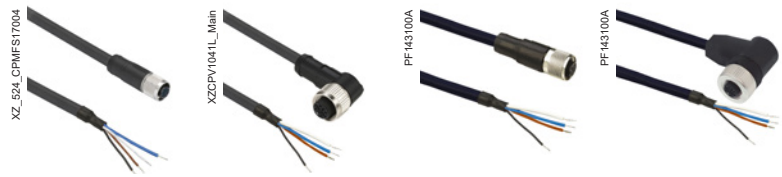

Connector type	Female, M8, straight	Female, M8, elbowed	Female, M12, straight	Female, M12, elbowed	
Number of conductors	4				
References					
PUR cable	L = 2 m	XZCP0941L2	XZCP1041L2	XZCP1141L2	XZCP1241L2
	L = 5 m	XZCP0941L5	XZCP1041L5	XZCP1141L5	XZCP1241L5
	L = 10 m	XZCP0941L10	XZCP1041L10	XZCP1141L10	XZCP1241L10
Weight (kg)	0 080 (L = 2 m) 0 180 (L = 5 m) 0 360 (L = 10 m)		0 090 (L = 2 m) 0 190 (L = 5 m) 0 370 (L = 10 m)		
Characteristics					
Certifications	cULus				
Connection type	Screw threaded (metal clamping ring)				
Cable material	Sheath	PUR			
	Conductor insulation	PP			
Degree of protection	IP65, IP67, IP69K				
Ambient air temperature	Static cable	-40...+80 °C			
	Flexing cable	-5...+80 °C			
Conductor c.s.a.	4 x 0.34 mm ²				
Cable diameter	5.2 mm				
Nominal voltage	60 V ~, 75 V ---		250 V ~, 300 V ---		
Nominal current	4 A				
Insulation resistance	> 10 ⁹ Ω				
Contact resistance	≤ 5 m Ω				

Connections

**XZCP0941L●,
XZCP1041L●**

**XZCP1141L●,
XZCP1241L●**

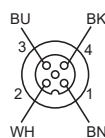
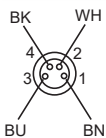

BN: Brown
WH: White
BU: Blue
BK: Black

Dimensions

XZCP0941L●

XZCP1041L●

XZCP1141L●

XZCP1241L●

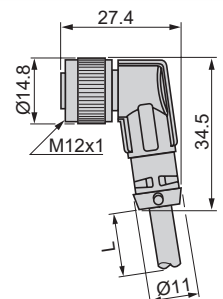
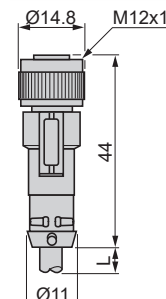
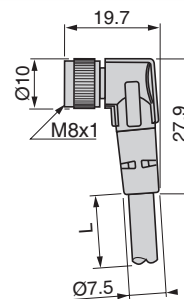
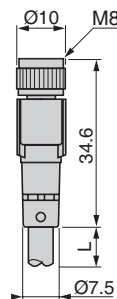

L = 2, 5 or 10 m

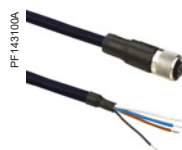

Connector type	Female, M12, straight	
Number of conductors	4	
References		
PUR cable	L = 2 m	XZCPB1141L2
	L = 5 m	XZCPB1141L5
Weight (kg)	0 200 (L = 2 m) 0 350 (L = 5 m)	

Characteristics		
Certifications	cULus	
Connection type	Screw threaded (metal clamping ring)	
Cable material	Sheath	PUR, shielded
	Conductor insulation	PP
Degree of protection	IP65, IP67	
Ambient air temperature	Static cable	-25...+80 °C
	Flexing cable	-5...+80 °C
Conductor c.s.a.	4 x 0.34 mm ²	
Cable diameter	5.9 mm	
Nominal voltage	250 V ~, 300 V ---	
Nominal current	4 A	
Insulation resistance	1 GΩ	
Contact resistance	5000 μOhm	

Connections

XZCPB1141L●

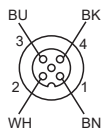

BN: Brown
WH: White
BU: Blue
BK: Black

Dimensions

XZCPB1141L●

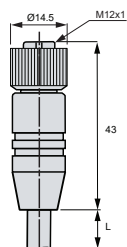

L = 2 or 5 m



Connector type	Female, M12, straight	Female, M12, elbowed	
Number of conductors	5		
References			
PUR cable	L = 2 m	XZCPB1151L2	XZCPB1251L2
	L = 5 m	XZCPB1151L5	XZCPB1251L5
Weight (kg)	0.114 (L = 2 m) 0.259 (L = 5 m)	0.113 (L = 2 m) 0.258 (L = 5 m)	

Characteristics		
Certifications	cULus	
Connection type	Screw threaded (nickel clamping ring)	
Cable material	Sheath	PUR, shielded
	Conductor insulation	PP
Degree of protection	IP65, IP67, IP69K	
Ambient air temperature	Static cable	-40...+90 °C
	Flexing cable	-25...+80 °C
Conductor c.s.a.	5 x 0.34 mm ²	
Cable diameter	5.85 mm	
Nominal voltage	250 V ~, 60 V ☰	
Nominal current	4 A	
Insulation resistance	> 10 ⁹ Ω	
Contact resistance	≤ 10 m Ω	

Connections

XZCPB1●51L●

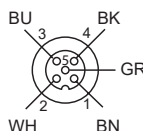

BN: Brown
WH: White
BU: Blue
BK: Black
GR: Grey

Dimensions

XZCPB1151L● **XZCPB1251L●**

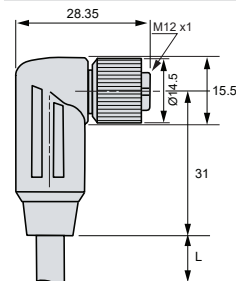
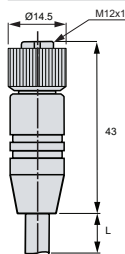

L = 2 or 5 m



Male connector type	M12, 4-pin, straight		
Female connector type	M12, 4-pin, straight	M12, 4-pin, elbowed	
Number of conductors	4		
References			
PVC cable	L = 1 m	XZCRV1511041C1	XZCRV1512041C1
	L = 2 m	XZCRV1511041C2	XZCRV1512041C2
	L = 5 m	XZCRV1511041C5	XZCRV1512041C5
Weight (kg)	0 070 (L = 1 m) 0 110 (L = 2 m) 0 230 (L = 5 m)		

Characteristics			
Certifications	cULus		
Connection type	Male and female: screw threaded		
Cable material	Sheath	PVC	
	Conductor insulation	PP	
Degree of protection	IP65, IP67		
Ambient air temperature	Static cable	-25...+80 °C	
	Flexing cable	-5...+80 °C	
Conductor c.s.a	4 x 0.25 mm ²		
Cable diameter	4 6 mm		
Nominal voltage	250 V ~, 300 V ≍		
Nominal current	3 A		
Insulation resistance	> 10 ⁹ Ω		
Contact resistance	≤ 5 m Ω		

Dimensions

XZCRV1511041C1, XZCRV1511041C2, XZCRV1511041C5

XZCRV1512041C1, XZCRV1512041C2, XZCRV1512041C5

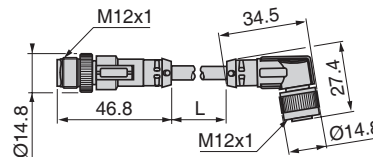
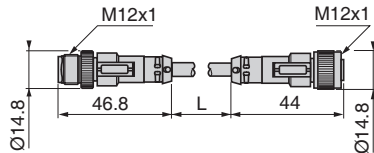

L = 2, 5 or 10 m

Connections

XZCRV1511041C●, XZCRV1512041C●

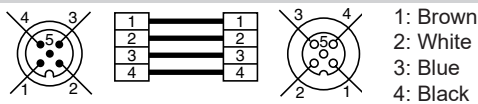



Male connector type	M12, 5-pin, straight	
Female connector type	M12, 5-pin, straight	
Number of conductors	5	
References		
PUR cable	L = 2 m	XZCRB151151C2
	L = 5 m	XZCRB151151C5
Weight (kg)	0 123 (L = 2 m) 0 267 (L = 5 m)	

Characteristics		
Certifications	cULus	
Connection type	Male and female: screw threaded	
Cable material	Sheath	PUR, shielded
	Conductor insulation	PP
Degree of protection	IP65, IP67, IP69K	
Ambient air temperature	Static cable	-40...+90 °C
	Flexing cable	-25...+80 °C
Conductor c.s.a	5 x 0.34 mm ²	
Cable diameter	5.85 mm ± 0.15 mm	
Nominal voltage	250 V ~, 60 V ---	
Nominal current	4 A	
Insulation resistance	> 10 ⁹ Ω	
Contact resistance	≤ 10 m Ω	

Dimensions

XZCRB151151C2, XZCRB151151C5

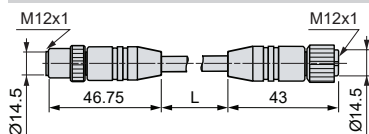

L = 2 or 5 m

Connections

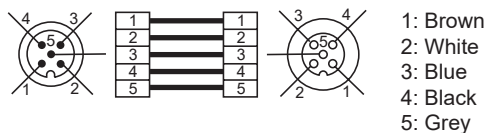

Photo-electric sensors

Cables for sensors, PUR

Jumper cables M8-M8, 3-pin/3-pin or 3-pin/4-pin



Male connector type	M8, 3-pin, straight		
Female connector type	M8, 3-pin, straight	M8, 3-pin, elbowed	M8, 4-pin, straight
Number of conductors	3		

References

PUR cable	L = 1 m	XZCR2705037R1	XZCR2706037R1	-
	L = 2 m	XZCR2705037R2	-	XZCR2709037S2
Weight (kg)	L = 1 m	0 065		
	L = 2 m	0 090		

Characteristics

Certifications	cULus		
Connection type	Male: screw threaded and clip .Female: screw threaded .Metal clamping ring .		
Cable material	Sheath	PUR	
	Conductor insulation	PP	
Degree of protection	IP65, IP67, IP69K		
Ambient air temperature	Static cable	-35...+90 °C	
	Flexing cable	-5...+90 °C	
Conductor c.s.a.	3 x 0.34 mm ²		
Cable diameter	5.2 mm		
Nominal voltage	60 V ~, 45 V -		
Nominal current	4 A		
Insulation resistance	> 10 ⁹ Ω		
Contact resistance	≤ 5 mΩ		

Dimensions

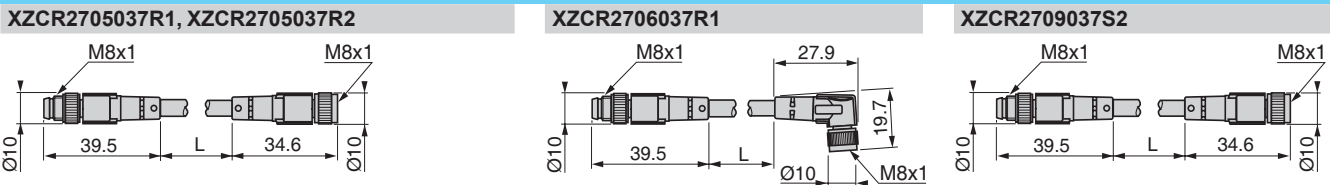

L = 1 or 2 m

Connections

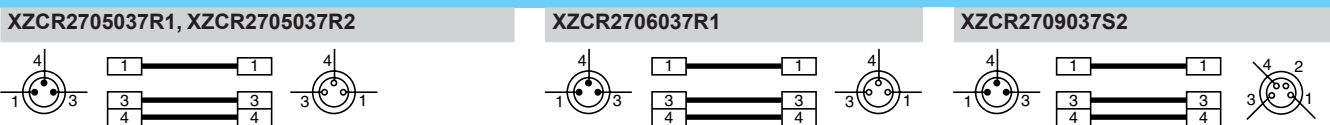



Male connector type	M8, 3-pin, straight		
Female connector type	M8, 4-pin, elbowed	M12, 5-pin, straight	M12, 5-pin, elbowed
Number of conductors	3		

References

PUR cable	L = 1 m	XZCR2710037S1	XZCR2711037T1	XZCR2712037T1
	L = 2 m	XZCR2710037S2	XZCR2711037T2	XZCR2712037T2
Weight (kg)	L = 1 m	0 065		
	L = 2 m	0 090	0 093	

Characteristics

Certifications	cULus		
Connection type	Male: screw threaded and clip .Female: screw threaded .Metal clamping ring		
Cable material	Sheath	PUR	
	Conductor insulation	PP	
Degree of protection	IP65, IP67, IP69K		
Ambient air temperature	Static cable	-35...+90 °C	
	Flexing cable	-5...+90 °C	
Conductor c.s.a.	3 x 0.34 mm ²		
Cable diameter	5.2 mm		
Nominal voltage	60 V ~, 45 V ---		
Nominal current	4 A		
Insulation resistance	> 10 ⁹ Ω		
Contact resistance	≤ 5 m Ω		

XZCR2710037S1, XZCR2710037S2 XZCR2711037T1, XZCR2711037T2 XZCR2712037T1, XZCR2712037T2

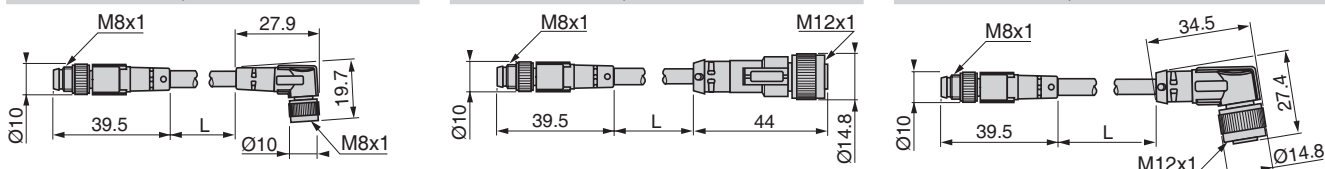

L = 1 or 2 m

XZCR2710037S1, XZCR2710037S2 XZCR2711037T1, XZCR2711037T2 XZCR2712037T1, XZCR2712037T2

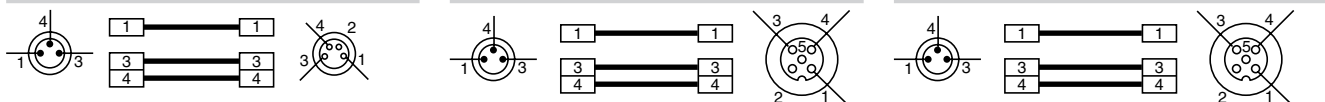

XU							
XUB2AKXNL2T	14	XUB9APXNL2	18	XUM5APYBL03M12	4	XUN5APXNM12	33
XUB2AKXNM12T	14	XUB9APXNM12	18	XUM5APYBM8	4	XUN5APYNM12	33
XUB2AKXWL2T	14	XUB9APXWL2	18	XUM6ANXBL03M12	4	XUN6ANXNL2	33
XUB2AKXWM12T	14	XUB9APXWM12	18	XUM6ANXBL03M8	4	XUN6ANXNM12	33
XUB2AKXNM12R	14	XUB9APYNM12	18	XUM6ANXBL2	4	XUN6APXNL2	33
XUB2ANXNL2R	14	XUB9APYWM12	18	XUM6ANXBM8	4	XUN6APXNM12	33
XUB2ANXNM12R	14	XUB9BNXNL2	19	XUM6APXBL03M12	4	XUN6APYNM12	33
XUB2ANXWL2R	14	XUB9BNXNM12	19	XUM6APXBL03M8	4	XUN9ANXNL2	34
XUB2ANXWM12R	14	XUB9BNXWL2	19	XUM6APXBL2	4	XUN9ANXNM12	34
XUB2APXNL2R	14	XUB9BNXWM12	19	XUM6APXBM8	4	XUN9APXNL2	34
XUB2APXNM12R	14	XUB9BPXNL2	19	XUM6APYBL03M12	4	XUN9APXNM12	34
XUB2APXWL2R	14	XUB9BPXNM12	19	XUM6APYBM8	4	XUN9APYNM12	34
XUB2APXWM12R	14	XUB9BPXWL2	19	XUM7ABPXL2	50 64	XUT7ABPXL2	50 64
XUB2APYNM12R	14	XUB9BPXWM12	19	XUM7ABPXM8	50 64	XUT7ABPXP02	50 64
XUB2APYWM12R	14	XUB9BPNM12	19	XUM8ABAYM8	50 64	XUT8ABAYL2	50 64
XUB2BKXNL2T	15	XUB9BPYWM12	19	XUM8ABAYP015	50 64	XUT8ABAYP02	50 64
XUB2BKXNM12T	15	XUK8ABPXM12	50 64	XUM8ALAYL2	56	XUT8ALAYL2	56
XUB2BKXWL2T	15	XUKCBLAYM12	62	XUM8ALAYM8	56	XUT8ALAYP02	56
XUB2BKXWM12T	15	XUKCBSAYM12	62	XUM8ALAYP015	56	XUT9ALPXL2	56
XUB2BNXNL2R	15	XUM2AKXBL03M12T	2	XUM8ANXBL2	3	XUT9ALPXP02	56
XUB2BNXNM12R	15	XUM2AKXBL03M8T	2	XUM8ANXBM8	3	XUZA118	74
XUB2BNXWL2R	15	XUM2AKXBL2T	2	XUM8APXBL2	3	XUZA218	74
XUB2BNXWM12R	15	XUM2AKXBM8T	2	XUM8APXBM8	3	XUZA50	74
XUB2BPXNL2R	15	XUM2ANXBL03M12	2	XUM9ALAYL2	56	XUZA51S	74
XUB2BPXNM12R	15	XUM2ANXBL03M12R	2	XUM9ALAYM8	56	XUZARK	74
XUB2BPXWL2R	15	XUM2ANXBL03M8	2	XUM9ALAYP015	56	XUZARM	74
XUB2BPXWM12R	15	XUM2ANXBL2	2	XUM9ANXBL03M12	3	XUZARS	74
XUB2BPNM12R	15	XUM2ANXBL2R	2	XUM9ANXBL03M8	3	XUZASB001	74
XUB2BPYWM12R	15	XUM2ANXBM8	2	XUM9ANXBL2	3	XUZASB002	74
XUB5ANXNL2	16	XUM2ANXBM8R	2	XUM9ANXBM8	3	XUZASB003	74
XUB5ANXNM12	16	XUM2APXBL03M12	2	XUM9APXBL03M12	3	XUZASK001	74
XUB5APXNL2	16	XUM2APXBL03M12R	2	XUM9APXBL03M8	3	XUZASM02	74
XUB5APXNM12	16	XUM2APXBL03M8	2	XUM9APXBL2	3	XUZASM03	74
XUB5BNXNL2	17	XUM2APXBL03M8R	2	XUM9APXBM8	3	XUZASM04	74
XUB5BNXNM12	17	XUM2APXBL2	2	XUM9APYBL03M12	3	XUZASM05	5
XUB5BPXNL2	17	XUM2APXBL2R	2	XUM9APYBM8	3	XUZASN001	74
XUB5BPXNM12	17	XUM2APXBM8	2	XUMRACAYM8	46 62	XUZASN002	74
XUB5BPNM12	17	XUM2APXBM8R	2	XUMRAGAYM8	46	XUZASS	74
XUB6ANXNL2	16	XUM2APYBL03M12	2	XUMRAGAYP015	46	XUZASW001	74
XUB6ANXNM12	16	XUM2APYBL03M12R	2	XUMRAWAYM8	46	XUZASW002	74
XUB6ANXWL2	16	XUM2APYBM8	2	XUMRAWAYP015	46	XUZC100	78
XUB6ANXWM12	16	XUM2APYBM8R	2	XUMTARAYL2	64	XUZC24	78
XUB6APXNL2	16	XUM4ANXBL03M12	4	XUMTARAYM8	64	XUZC39	78
XUB6APXNM12	16	XUM4ANXBL03M8	4	XUMTARAYP015	64	XUZC50	78
XUB6APXWL2	16	XUM4ANXBL2	4	XUN2AKXNL2T	32	XUZC60S11	78
XUB6APXWM12	16	XUM4ANXBM8	4	XUN2AKXNM12T	32 41	XUZDHM05	5
XUB6APYNM12	16	XUM4APXBL03M12	4	XUN2AKXNL2T	32	XUZDHM10	5
XUB6APYWM12	16	XUM4APXBL03M8	4	XUN2ANXNL2	32	XUZDHM20	5
XUB6BNXNL2	17	XUM4APXBL2	4	XUN2ANXNL2R	32	XUZDRM05	5
XUB6BNXNM12	17	XUM4APXBM8	4	XUN2ANXNM12	32	XUZDRM10	5
XUB6BNXWL2	17	XUM5ALAYL2	46 56	XUN2ANXNM12R	32	XUZDRM20	5
XUB6BNXWM12	17	XUM5ALAYM8	46 56	XUN2APXNL2	32	XUZDVM05	5
XUB6BPXNL2	17	XUM5ALAYP015	46 56	XUN2APXNL2R	32	XUZDVM10	5
XUB6BPXNM12	17	XUM5ANXBL03M12	4	XUN2APXNM12	32	XUZDVM20	5
XUB6BPXWL2	17	XUM5ANXBL03M8	4	XUN2APXNM12R	32		
XUB6BPXWM12	17	XUM5ANXBL2	4	XUN2APYNM12	32	XZ	
XUB6BPNM12	17	XUM5ANXBM8	4	XUN2APYNM12R	32	XZCP0941L10	80 83
XUB6BPYWM12	17	XUM5APXBL2	4	XUN5ANXNL2	33	XZCP0941L2	80 83
XUB9ANXNL2	18	XUM5APXBM8	4	XUN5ANXNM12	33		
XUB9ANXNM12	18			XUN5APXNL2	33		
XUB9ANXWL2	18					XZCP0941L5	80 83
XUB9ANXWM12	18					XZCP1041L10	80 83
						XZCP1041L2	80 83
						XZCP1041L5	80 83
						XZCP1141L10	80 83
						XZCP1141L2	80 83
						XZCP1141L5	80 83
						XZCP1241L10	80 83
						XZCP1241L2	80 83
						XZCP1241L5	80 83
						XZCPB1141L2	80 84
						XZCPB1141L5	80 84
						XZCPB1151L2	80 85
						XZCPB1151L5	80 85
						XZCPB1251L2	80 85
						XZCPB1251L5	80 85
						XZCPK75CL2	71
						XZCPK75CL5	71
						XZCPK75DL2	71
						XZCPK75DL5	71
						XZCPV0941L10	80 82
						XZCPV0941L2	80 82
						XZCPV0941L5	80 82
						XZCPV1041L10	80 82
						XZCPV1041L2	80 82
						XZCPV1041L5	80 82
						XZCPV1141L10	80 82
						XZCPV1141L2	80 82
						XZCPV1141L5	80 82
						XZCPV1241L10	80 82
						XZCPV1241L2	80 82
						XZCPV1241L5	80 82
						XZCR25K25DL2	71
						XZCR25K25DL5	71
						XZCR26K26CL2	71
						XZCR26K26CL5	71
						XZCR2705037R1	81 88
						XZCR2705037R2	81 88
						XZCR2706037R1	81 88
						XZCR2709037S2	81 88

XZCR2710037S1	81 89
XZCR2710037S2	81 89
XZCR2711037T1	81 89
XZCR2711037T2	81 89
XZCR2712037T1	81 89
XZCR2712037T2	81 89
XZCRB151151C2	81 87
XZCRB151151C5	81 87
XZCRV1511041C1	81 86
XZCRV1511041C2	81 86
XZCRV1511041C5	81 86
XZCRV1512041C1	81 86
XZCRV1512041C2	81 86
XZCRV1512041C5	81 86
XZIOM8AM12EY	71
XZIOM8AM12PY	71