Emergency stop rope pull switches Preventa XY2C

Catalogue



Simply easy!™

 **Telemecanique**
Sensors

Emergency stop rope pull switches Preventa XY2CJ, XY2CH, XY2CE and XY2CED

- **General**
 - Presentation page 2
 - Installation page 3
 - Basic principles page 3
 - Rope pull expansion or contraction page 4
 - Standards page 4
 - Adjustment values with end spring pages 4 and 5
- **Characteristics** pages 6 and 7
- **References**
 - Emergency stop rope pull switches with single anchor point pages 8 to 10
 - Emergency stop rope pull switches with double anchor point page 11
 - Separate parts pages 12 and 13
 - Mounting kits page 14
 - Replacement parts page 15
- **Dimensions** pages 16 and 17
- **Product reference index** page 18

Safety detection solutions

Emergency stop rope pull switches

Preventa XY2C

Emergency stop rope pull switches

Emergency stop rope pull switches are designed to:

- avert hazards (dangerous phenomena) at the earliest possible moment, or to reduce risks which could cause injury to persons or damage either to machines or work in progress
- be tripped by a single human action when a normal emergency stop function is not available
- trip in the event of the rope pull breaking

Emergency stop rope pull switches are essential in premises and on machines that are potentially dangerous when operating. The operator must be able to trigger the stop instruction at any point within their working area.

Application examples: woodworking machines, shears, conveyor systems, printing machines, textile machines, rolling mills, test laboratories, paint shops, surface treatment works, etc.

Preventa XY2CJ, XY2CH and XY2CE emergency stop rope pull switches with single anchor point

- > 20 to 70 m cable
- > Rugged, compact offer, UL NiSD certified
- > Simple installation and maintenance using dedicated accessories (pilot light, quick tensioner, and cable tension indicator)

UL NiSD certified



Preventa XY2CJ compact range



Preventa XY2CED emergency stop rope pull switches with double anchor points

- > Long cable (up to 2 x 100 m with supports and pulleys)
- > Rugged offer, UL NiSD certified
- > Easy mounting with aid of simple, dedicated accessories (removable shim for adjusting cable tension, quick tensioner, cable tension indicator, etc.)

2 x 100 m max. cable



Preventa XY2CED range with double anchor points



+ Certified, rugged safety devices that are easy to install

Safety detection solutions

Emergency stop rope pull switches

Preventa XY2C

Installation

Description of a typical installation for XY2CJ, XY2CH and XY2CE (1)

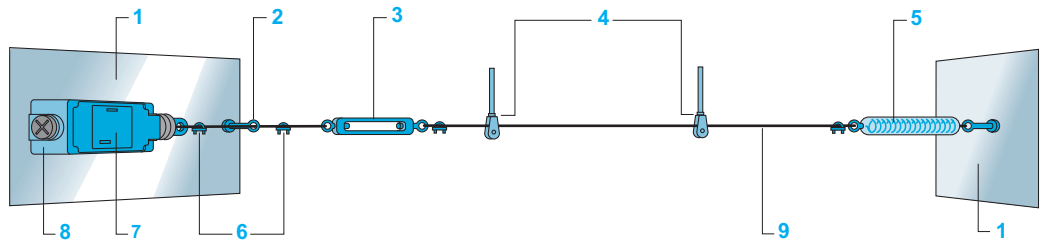

- 1 Mounting support
- 2 First cable support
- 3 Turnbuckle
- 4 Pulleys and pulley supports
- 5 End spring
- 6 Cable grips
- 7 Switch adjustment
- 8 Emergency stop
- 9 Cable

Notes regarding installation

- XY2CJ, XY2CH, XY2CE and XY2CED emergency stop rope pull switches can be fitted with trip indicators (mechanical indicators for XY2CJ, pilot lights for XY2CH, XY2CE and XY2CED).
- The cable tension can be adjusted using:
 - a turnbuckle to be ordered separately (see page 12)
 - a quick tensioner integrated in XY2CH emergency stop rope pull switches and optional for XY2CJ, XY2CE and XYCED emergency stop rope pull switches
- This adjustment is simplified by:
 - a cable tension indicator that is available on XY2CJ, XY2CH and XY2CE models. XY2CE emergency stop rope pull switches incorporate a cable tension indicator that is visible with the cover open. There is also an optional version with a window for viewing the cable tension, so that it can be adjusted when the cover is closed (excludes XY2CED models).
- For XY2CED emergency stop rope pull switches with double anchor points, the cable tension is visible on both end springs. A removable adjustment shim can be used to preset the balance between the left and right anchor points. The end springs and shim are supplied with the product.
- The use of an end spring is mandatory for conveyor system applications to allow operation of the emergency stop in the event of the cable being pulled towards the switch.
- For Preventa XY2CED switches, use of the model-specific end springs is mandatory, regardless of the application.
- It is essential that pulleys be used with cables that deviate from a straight run (within the permissible angles. Refer to the mounting instructions).

Basic principles

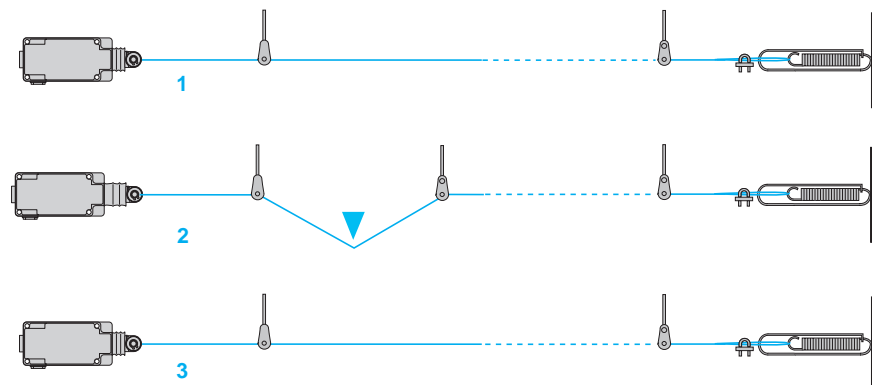

- | | |
|---|---|
| Positive operation: running condition | 1 The switches incorporate positive opening operation contacts, the tripping of the switch being made with positive action. |
| Latching: stop instruction given (tripped) | 2 The switch latches in the tripped position (NC safety contact(s) open). The function of the NO contact is purely for signaling. |
| Resetting: stop condition (awaiting reset/restart) | 3 The switches incorporate a reset button, which re-closes the safety contact. The machine must only be restarted by manual operation of a control device within the machine start circuit, remote to the emergency stop. |

(1) See the description of a typical Preventa XY2CED installation on our website www.tesensors.com

Safety detection solutions

Emergency stop rope pull switches

Preventa XY2C

Rope pull expansion or contraction: d

This is the expansion or contraction of the rope pull cable. Temperature variations encountered on site are mainly responsible for these variations in length.

To enable instant verification that the rope pull is at its correct tension (and make any necessary adjustments), XY2CJ, XY2CH, and XY2CE emergency stop rope pull switches incorporate a cable tension indicator.

XY2CE emergency stop rope pull switches incorporate a cable tension indicator that is visible with the cover open. They are also available with a window for viewing the cable tension, enabling instant verification that the rope pull is at its correct tension (and to allow any necessary adjustments to be made) (excludes XY2CED models).

For XY2CED, the cable tension indicator is visible on the model-specific end springs supplied with the product.

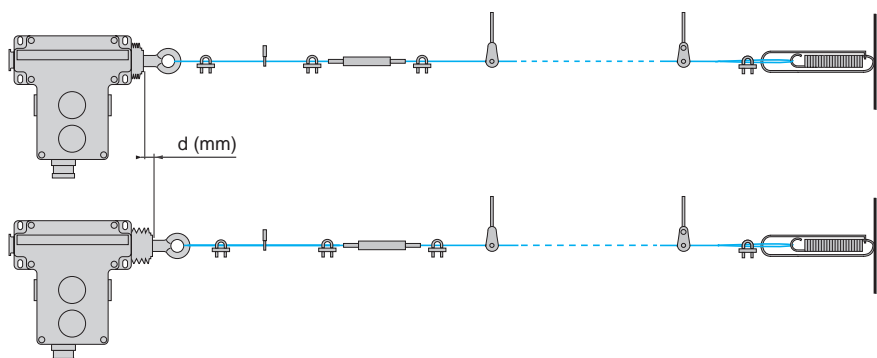

Standards

XY2CJ, XY2CH, XY2CE, and XY2CED switches meet the requirements of the harmonized European standard **EN/ISO 13850**, relating to "Emergency stop devices". The switches are **CE** marked and supplied with an EC declaration of conformity.

Cable diameter

In order to achieve the maximum cable length, according to ambient temperature variation, we recommend use of:

- galvanized cables with red sheath, diameter 3.2 mm for XY2CJ and XY2CH ranges
- galvanized cables with red sheath, diameter 5 mm for XY2CE and XY2CED ranges (see page 12)

Adjustment values with end spring

For Preventa XY2CE emergency stop rope pull switches, the adjustment values depend on the positions of the cam located inside the switch. The adjustment is made by rotating the cam after the switch has been installed. Each notched cam position is referenced by the letters A to F and the selected letter is visible through a viewing window. The use of end springs is strongly advised (mandatory for XY2CED). The references for each type are given in the table below:

Type	Cam position	Maximum cable length	End spring
XY2CJS	–	20 m	XY2CZ703
XY2CJR and XY2CJL	–	30 m	XY2CZ703
XY2CH	–	30 m	XY2CZ703
XY2CE	A, B, C, D, E, F	70 m	XY2CZ702
XY2CED	–	2 X 100 m (with pulleys) 2 x 70 m (with fixed cable supports)	XY2CZ712 (2 end springs supplied with the product)

XY2CJ

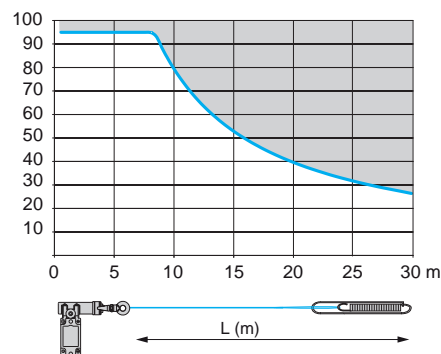
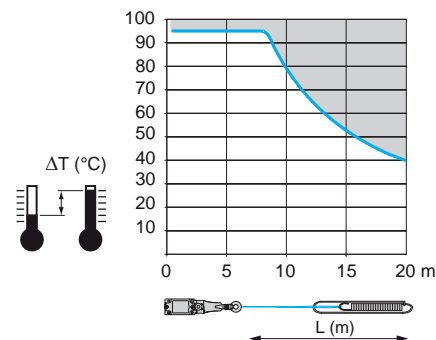

■ : Prohibited zone

With the graphs above, if we consider an ambient temperature variation of 25 °C, for example from 0 °C to + 25 °C, the table gives us a maximum cable length of 20 m for XY2CJS and 30 m for XY2CJR and XY2CJL.

Adjustment values with end spring
(continued)

XY2CH

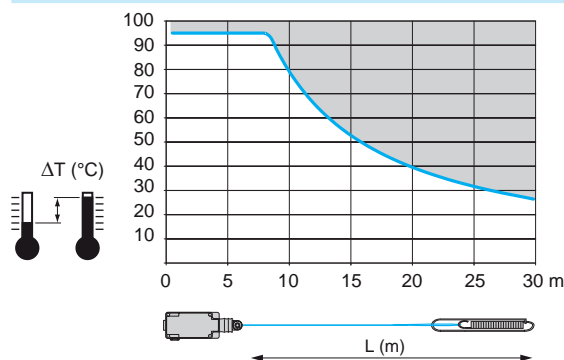

With the graph above, if we consider an ambient temperature variation of 25 °C, for example from 0 °C to + 25 °C, the table gives us a maximum cable length of 30 m.

XY2CE

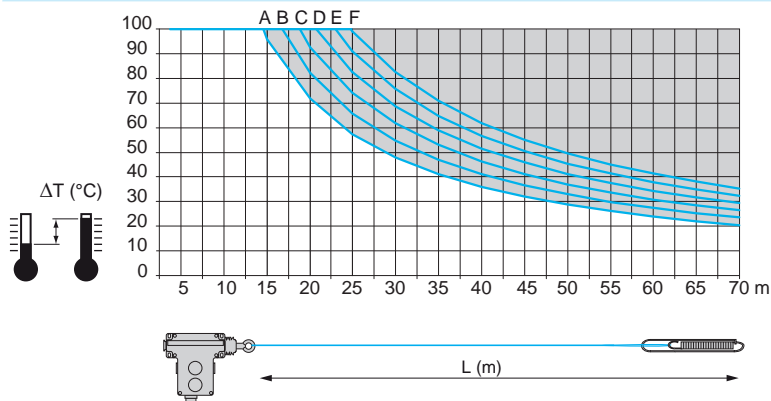

With the graph above, if we consider an ambient temperature variation of 35 °C, for example from - 10 °C to + 25 °C, the table gives us a maximum cable length of:

- 40 m, with cam A adjustments
- 70 m, with cam F adjustments

XY2CED

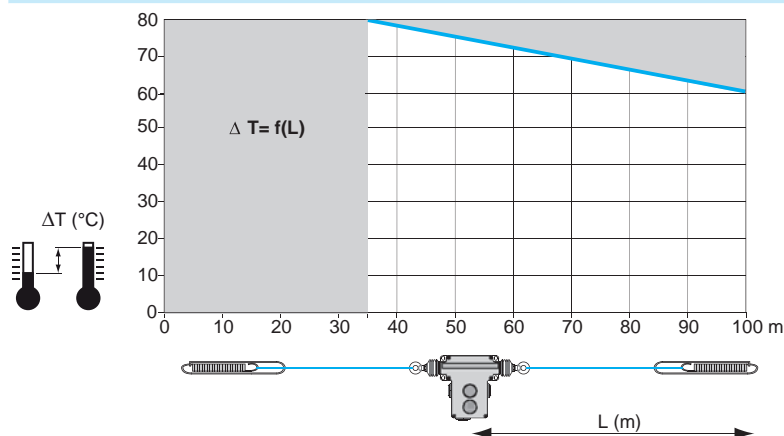

: Prohibited zone

With the graph above, if we consider an ambient temperature variation of 65 °C, the maximum cable length on each side will be 85 m (2 x 85 m).

Environment		
Conforming to standards	Products	EN/IEC 60947-5-5, EN/ISO 13850, UL 508 and CSA C 22-2 no. 14
	Machine assemblies	EN/IEC 60204-1, Machinery directive: 2006/42/EC Work equipment directive: 2009/104/EC
Product certifications		XY2CJ: UL (NISD) - CSA, CCC XY2CH: UL (NISD) - CSA (with suffix H7), EAC, CCC (1) XY2CE, XY2CED: UL (NISD) - CSA, EAC, CCC
Maximum safety level (2)		PL e, category 4 conforming to EN/ISO 13849-1 and SIL CL3 conforming to EN/IEC 62061
Reliability data B _{10d}		XY2CJ: 500,000 XY2CH: 4,000,000 XY2CE, XY2CED: 300,000 (Values given for a service life of 20 years but may be limited by contact and mechanical wear)
Ambient air temperature	For operation	- 25...+ 70 °C (- 40...+ 70 °C for XY2CH, XY2CE and XY2CED with booted reset pushbutton and silicone bellows)
	For storage	- 40...+ 70 °C
Vibration resistance		XY2CJ, XY2CH: 10 gn (10...150 Hz) XY2CE, XY2CED: 10 gn (10...300 Hz) conforming to EN/IEC 60068-2-6
Shock resistance		XY2CJ, XY2CH, XY2CE: 50 gn (duration 11 ms) conforming to EN/IEC 60068-2-27 XY2CED: 35 gn (duration 11 ms) conforming to EN/IEC 60068-2-27
Electric shock protection		Class I conforming to IEC 61140
Degree of protection		XY2CJ: IP 66 and IP 67 conforming to IEC 60529 XY2CH, XY2CE: IP 65 conforming to IEC 60529 (IP 66 for XY2CE●A●●●, Y2CE●C●●●) XY2CED: IP 66 conforming to IEC 60529
Materials		XY2CJS: Zamak body, polyamide head, zinc-plated steel cover XY2CJL, XY2CJR: Zamak body and head, zinc-plated steel cover XY2CH, XY2CE, XY2CED: Zamak body, stainless steel cover
Mechanical life (no. of operating cycles)		XY2CJ: 100,000 XY2CH: 800,000 XY2CE, XY2CED: 60,000
Length of protected zone		XY2CJS: ≤ 20 m XY2CJR and XY2CJL: ≤ 30 m XY2CH: ≤ 30 m XY2CE: ≤ 70 m XY2CED: ≥ 2 x 35 m to 2 x 100 m
Distance between cable supports		XY2CJ, XY2CH, XY2CE: 5 m XY2CED: 3 to 5 m
Cable entries		XY2CJ, XY2CH: Tapped entries for ISO M20, Pg 13.5 or 1/2" NPT cable gland XY2CE, XY2CED: Untapped entries for ISO M20 or Pg 13.5 cable gland, tapped entries for 1/2" NPT cable gland See dimensions on page 16.

(1) Only XY2CH products without pilot light are CCC approved.

(2) When the emergency stop rope pull switch is used with an appropriate and correctly connected control system. Only models with 2 NC contacts can be used with an emergency stop monitoring safety relay.

Contact block characteristics		
Rated operational characteristics	2-pole contact block	XY2CJ, XY2CH, XY2CE, XY2CED: AC-15: A300 or Ue = 240 V, Ie = 3 A DC-13: Q300 or Ue = 250 V, Ie = 0.27 A, conforming to EN/IEC 60947-5-1 Appendix A
	3-pole contact block	XY2CJ, XY2CH: AC-15: B300 or Ue = 240 V, Ie = 1.5 A DC-13: R300 or Ue = 250 V, Ie = 0.1 A, conforming to EN/IEC 60947-5-1 Appendix A
Nominal thermal current	2-pole contact block	10 A
	3-pole contact block	6 A
Rated insulation voltage	2-pole contact block	XY2CJ, XY2CH, XY2CE, XY2CED: Ui = 500 V degree of pollution 3 conforming to EN/IEC 60947-1, Ui = 300 V conforming to UL 508, CSA C22-2 no. 14
	3-pole contact block	XY2CJ, XY2CH: Ui = 400 V degree of pollution 3 conforming to EN/IEC 60947-1, Ui = 300 V conforming to UL 508, CSA C22-2 no. 14
Rated impulse withstand voltage	2-pole contact block	XY2CJ, XY2CH, XY2CE, XY2CED: Uimp = 6 kV conforming to EN/IEC 60947-1
	3-pole contact block	XY2CJ, XY2CH: Uimp = 4 kV conforming to EN/IEC 60947-1
Positive operation	NC contact with positive opening operation conforming to EN/IEC 60947-5-1 Section 3	
Resistance across terminals	≤ 25 mΩ conforming to NF C 93-050 method A or EN/IEC 60255-7 category 3	
Terminal referencing	Conforming to CENELEC EN 50013	
Short-circuit protection	2-pole contact block	XY2CJ, XY2CH, XY2CE, XY2CED: 10 A cartridge fuse type gG (gl) conforming to EN/IEC 60269
	3-pole contact block	XY2CJ, XY2CH: 6 A cartridge fuse type gG (gl) conforming to EN/IEC 60269

Rated operational power
(Electrical durability)

XY2CJ, XY2CH, XY2CE, XY2CED
Conforming to EN/IEC 60947-5-1 Appendix C. Utilization categories AC-15 and DC-13
Frequency: 3,600 operating cycles/hour. Load factor: 0.5

AC supply ~ 50/60 Hz
mm Inductive circuit

2-pole contact block

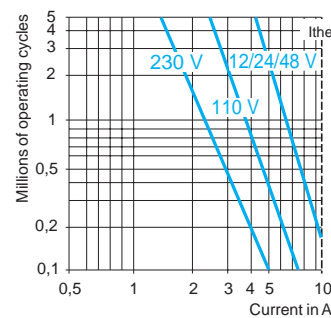

3-pole contact block

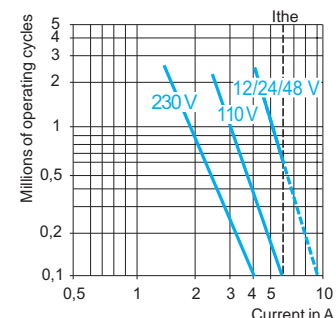

DC supply ---
Breaking current
for 1 million operating cycles.
mm Inductive circuit

	Voltage V	24	48	120	Voltage V	24	48	120	
mm	W	13	9	7	mm	W	4	3	2

Contact connection	Screw clamp terminals 2 contacts: clamping capacity, min. 1 x 0.5 mm ² /AWG 20, max. 2 x 1.5 mm ² /AWG 16 3 contacts: clamping capacity, min. 1 x 0.34 mm ² /AWG 22, max. 1 x 1 mm ² /AWG 18 or 2 x 0.75 mm ² /AWG 20 Minimum tightening torque: 0.8 N.m/7.1 lb-in. Maximum tightening torque: 1.2 N.m/10.6 lb-in.
---------------------------	--

Safety detection solutions

Emergency stop rope pull switches

Preventa XY2CJ

Emergency stop rope pull switches with single anchor point ISO M20, Pg 13.5 and 1/2" NPT

Cable and end spring to be ordered separately (1)

Without pilot light

PF123235



XY2CJS15

PF123234



XY2CJR15

PF123233

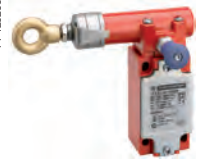

XY2CJL15

Cable length	Colors and materials	Reset	Supply voltage	Contact type	Cable anchor point	Reference	Weight kg	
≤ 20 m	Polyamide head Zamak red RAL 3000 body Treated steel cover	By pull button	–	1 1	NC + NO slow break	RH side or LH side	XY2CJS15 (2)	0.455
				2 –	NC + NC slow break	RH side or LH side	XY2CJS17 (2)	0.455
				2 1	2 NC + 1 NO slow break	RH side or LH side	XY2CJS19 (2) (3)	0.455
≤ 30 m	Zamak red RAL 3000 head and body Treated steel cover	By pull button	–	1 1	NC + NO slow break	RH side	XY2CJR15 (2)	0.669
				2 –	NC + NC slow break	RH side	XY2CJR17 (2)	0.669
				2 1	2 NC + 1 NO slow break	RH side	XY2CJR19 (2) (3)	0.669
				1 1	NC + NO slow break	LH side	XY2CJL15 (2)	0.669
				2 –	NC + NC slow break	LH side	XY2CJL17 (2)	0.669
				2 1	2 NC + 1 NO slow break	LH side	XY2CJL19 (2) (3)	0.669

(1) See separate parts on page 12.

(2) For ISO M20 tapped cable entry version, add H29 to the end of the selected reference.

For example: **XY2CJS15** becomes **XY2CJS15H29**.

(3) For 1/2" NPT tapped cable entry version, add H7 to the end of the selected reference.

For example: **XY2CJS19** becomes **XY2CJS19H7**.

Safety detection solutions

Emergency stop rope pull switches

Preventa XY2CH

Emergency stop rope pull switches with single anchor point ISO M20, Pg 13.5 and 1/2" NPT with integrated tensioner

Cable and end spring to be ordered separately (1)

Without pilot light

Cable length	Colors and materials	Reset	Supply voltage	Contact type	Cable anchor point	Reference	Weight kg	
≤ 30 m	Zamak red RAL 3000 body Stainless steel cover Chloroprene bellows	By flush pushbutton	–	1 1	NC + NO slow break	RH side or LH side	XY2CH13150 (4)	0.865
		By booted pushbutton	–	1 1		RH side or LH side	XY2CH13250 (3) (4)	0.865
		By mushroom head pushbutton	–	1 1			XY2CH13350 (4)	0.900
		By key-operated pushbutton (key no. 421) (2)	–	1 1			XY2CH13450 (3) (4)	0.910
≤ 30 m	Red RAL 3000 body Stainless steel cover Chloroprene bellows	By flush pushbutton	–	2 –	NC + NC slow break	RH side or LH side	XY2CH13170 (3) (4)	0.865
		By booted pushbutton	–	2 –			XY2CH13270 (3) (4)	0.865
		By mushroom head pushbutton	–	2 –			XY2CH13370 (3)	0.865
≤ 30 m	Red RAL 3000 body Stainless steel cover Chloroprene bellows	By key-operated pushbutton (key no. 421) (2)	–	2 –			XY2CH13470 (3) (4)	0.910
		By flush pushbutton	–	2 1	2 NC + 1 NO slow break	RH side or LH side	XY2CH13190 (3) (4)	0.865
		By booted pushbutton	–	2 1			XY2CH13290 (3) (4)	0.865
		By mushroom head pushbutton	–	2 1			XY2CH13390 (3) (4)	0.865

With orange pilot light (direct supply)

≤ 30 m	Red RAL 3000 body Stainless steel cover Chloroprene bellows	By booted pushbutton	24 V ~/–	1 1	NC + NO slow break	RH side or LH side	XY2CH13253 (3)	0.900
				2 –	NC + NC slow break		XY2CH13273	0.900
				2 1	2 NC + 1 NO slow break		XY2CH13293 (3)	0.950

Other versions

Versions with silicon bellows
Please contact our Customer Care Center.

(1) See separate parts on page 12.

(2) Ø 30 spring return key-operated mushroom head pushbutton.

(3) For ISO M20 tapped cable entry version, add H29 to the end of the selected reference.

For example: XY2CH13250 becomes XY2CH13250H29.

(4) For 1/2" NPT tapped cable entry version, add H7 to the end of the selected reference.

For example: XY2CH13190 becomes XY2CH13190H7.



XY2CH13250



XY2CH13350



XY2CH13170



XY2CH13253

Safety detection solutions

Emergency stop rope pull switches

Preventa XY2CE

Emergency stop rope pull switches with single anchor point ISO M20 or Pg 13.5 (1) and 1/2" NPT (2)

Turnbuckle, quick tensioner, cable, and end spring to be ordered separately (3)

Without pilot light

Cable length	Colors and materials	Reset	Supply voltage	Contact type	Cable anchor point	Reference	Weight kg	
≤ 70 m	Zamak red RAL 3000 body Stainless steel cover Nitrile bellows	By flush pushbutton	–	1 1	NC + NO slow break	RH side	XY2CE1A150 (2)	1.450
						LH side	XY2CE2A150 (2)	1.450
		By booted pushbutton	–	1 1	NC + NO slow break	RH side	XY2CE1A250 (2)	1.450
						LH side	XY2CE2A250 (2)	1.450
				2 –	NC + NC slow break	RH side	XY2CE1A270 (2)	1.450
						LH side	XY2CE2A270 (2)	1.450
				2 2	NC + NO slow break	RH side	XY2CE1A290 (2)	1.450
						LH side	XY2CE2A290 (2)	1.450
		By key switch (key no. 421)	–	1 1	NC + NO slow break	RH side	XY2CE1A450	1.465
						LH side	XY2CE2A450 (2)	1.465
				2 –	NC + NC slow break	RH side	XY2CE1A470	1.470
						LH side	XY2CE2A470	1.470

With yellow LED pilot light (direct supply)

≤ 70 m	Zamak red RAL 3000 body Stainless steel cover Nitrile bellows	By booted pushbutton	24 to 130 V ~/-	2 2	NC + NO slow break	RH side	XY2CE1A296 (2)	1.470
						LH side	XY2CE2A296 (2)	1.470
			230 to 240 V ~	2 2	NC + NO slow break	RH side	XY2CE1A297 (2)	1.470
						LH side	XY2CE2A297 (2)	1.470

Other versions

- ATEX versions
 - Versions with low tripping force (< 125 N). Rope pull tripping deflection < 300 mm
 - Versions with reset by Ø 30 mm mushroom head pushbutton
 - Versions with cable tension viewing window for adjustment when the cover is closed
 - Versions with silicon bellows
- Please contact our Customer Care Center.

(1) With untapped entries for ISO M20 or Pg 13.5 cable gland.

(2) For 1/2" NPT tapped cable entry version, add H7 to the end of the selected reference (for these versions, the pilot light is red).
For example: XY2CE1A250 becomes XY2CE1A250H7.

(3) See separate parts on page 12.

PF123209



XY2CE2A250

PF123203



XY2CE1A450

PF123212



XY2CE2A450

PF123210



XY2CE2A296

PF123202



XY2CE1A296H7

XY2C_020_CP00A2016021



Emergency stop rope pull switch with window for viewing the cable tension

Safety detection solutions

Emergency stop rope pull switches

Preventa XY2CED

PF123244



XY2CEDA190

PF123247



XY2CEDA290

PF123250



XY2CEDA590

PF123245

XY2CEDA196
XY2CEDA197

PF123248

XY2CEDA296
XY2CEDA297

PF123252









XY2CEDA296H7









Emergency stop rope pull switches with double anchor point ISO M20 or Pg 13.5 and 1/2" NPT

Turnbuckle and cable to be ordered separately (1)

Without pilot light

Cable length	Colors and materials	Reset	Supply voltage	Contact type	Reference (2)	Weight kg
$L \geq 2 \times 35 \text{ m}$ $L \leq 2 \times 70 \text{ m}$ ($L \geq 2 \times 35 \text{ m}$ $L \leq 2 \times 100 \text{ m}$ with pulleys and pulley supports)	Zamak red RAL 3000 body Stainless steel cover Nitrile bellows	By flush pushbutton	–		XY2CEDA190 (3)	1.900
		By booted pushbutton	–		XY2CEDA290 (3)	1.900
		By key-operated pushbutton (key no. 455)	–		XY2CEDA590	1.900
	Zamak red RAL 3000 body Stainless steel cover Silicon bellows	By flush pushbutton	–		XY2CEDC190	1.900
		By booted pushbutton	–		XY2CEDC290	1.900
		By key-operated pushbutton (key no. 455)	–		XY2CEDC590	1.900

With yellow LED pilot light (direct supply)

$L \geq 2 \times 35 \text{ m}$ $L \leq 2 \times 70 \text{ m}$ ($L \geq 2 \times 35 \text{ m}$ $L \leq 2 \times 100 \text{ m}$ with pulleys and pulley supports)	Zamak red RAL 3000 body Stainless steel cover Nitrile bellows	By flush pushbutton	$\sim/\text{---} 24 \text{ to } 130 \text{ V}$		XY2CEDA196 (3)	1.900
			$\sim 230 \text{ to } 240 \text{ V}$		XY2CEDA197	1.900
		By booted pushbutton	$\sim/\text{---} 24 \text{ to } 130 \text{ V}$		XY2CEDA296 (3)	1.900
			$\sim 230 \text{ to } 240 \text{ V}$		XY2CEDA297	1.900
		By key-operated pushbutton (key no. 455)	$\sim/\text{---} 24 \text{ to } 130 \text{ V}$		XY2CEDA596 (3)	1.900
			$\sim 230 \text{ to } 240 \text{ V}$		XY2CEDA597	1.900
	Zamak red RAL 3000 body Stainless steel cover Silicon bellows	By flush pushbutton	$\sim/\text{---} 24 \text{ to } 130 \text{ V}$		XY2CEDC296	1.900
		By booted pushbutton	$\sim 230 \text{ to } 240 \text{ V}$		XY2CEDC297	1.900

Other versions

- ATEX versions.
- Versions with low tripping force (< 125 N)
Rope pull tripping deflection < 300 mm. Maximum cable length: 2 x 50 m.
Minimum cable length: 2 x 3.6 m.

Contact our Customer Care Center.

(1) See separate parts on page 12.

(2) XY2CED emergency stop rope pull switches are supplied with an adjustment shim XY2CZ713 and 2 end springs XY2CZ712.

(3) For 1/2" NPT tapped cable entry version, add H7 to the end of the selected reference (for these versions, the pilot light is red).
For example: XY2CEDA190 becomes XY2CEDA190H7.

Safety detection solutions

Emergency stop rope pull switches

Preventa XY2C

XY2C_620_CP00A02018018



XY2CZ30●●

Separate parts

Description	For use with	Diameter mm	Length m	Reference	Weight kg
Galvanized cables with red sheath	XY2CJ and XY2CH	3.2	10.5	XY2CZ301	0.280
			15.5	XY2CZ3015	0.410
			20.5	XY2CZ3020	0.550
	XY2CE	5	25.5	XY2CZ302	0.690
			30.5	XY2CZ303	0.830
			15.5	XY2CZ1015	0.850
XY2CE and XY2CED	5	25.5	XY2CZ102	1.400	
		50.5	XY2CZ105	2.750	
		70.5	XY2CZ107	3.870	
100.5	XY2CZ110	5.520			

PF123239

XY2CZ210
XY2CZ213

Description	Type	For use with	Sold in lots of	Unit reference	Weight kg
Quick tensioners	-	XY2CJ	1	XY2CZ210	0.051
		XY2CE and XY2CED	1	XY2CZ213	0.090
Shim for adjusting cable tension	-	XY2CED	1	XY2CZ713 (1)	0.010
Turnbuckles	M6 x 60 + locknut	XY2CJ	1	XY2CZ402	0.060
		XY2CE, XY2CH and XY2CJ (2)	1	XY2CZ404	0.100
	M8 x 180 + locknut	XY2CED	2	XY2CZ403	0.180

PF123260



XY2CZ713

PF123259

XY2CZ402
XY2CZ403
XY2CZ404





(1) An adjustment shim XY2CZ713 and 2 end springs XY2CZ712 are supplied with XY2CED switches.

(2) XY2CH13●●● and XY2CH14●●● emergency stop rope pull switches incorporate a cable tensioner as standard. Therefore, there is no need to order a turnbuckle.

Safety detection solutions

Emergency stop rope pull switches

Preventa XY2C

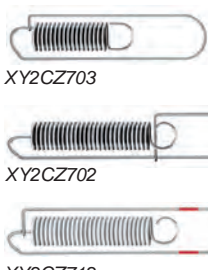
		Separate parts (continued)					
		Description	Type	For use with	Order in multiples of	Unit reference	Weight kg
 XY2CZ503 XY2CZ513	XY2C_620_CP0DA2016006	Cable grips	Single	Cable Ø 3.2 mm	10	XY2CZ503	0.007
			Double	Cable Ø 3.2 mm	10	XY2CZ513	0.016
		 XY2CZ523	XY2C_620_CP0DA2016007	Clamp		Cable Ø 3.2 mm	10
	Cable Ø 5 mm				10	XY2CZ524	0.080
 XY2CZ705 XY2CZ601	PF123265 PF123284	Cable supports	Fixed	All models	1	XY2CZ601	0.030
					10	XY2CZ611	0.032
			Swiveling	All models	1	XY2CZ602	0.130
			Pulley support	All models	1	XY2CZ705	0.060
10	XY2CZ715	0.650					
 XY2CZ708 XY2CZ602	PF123283 XY2C_620_CP0DA2016008	Pulleys	Cable Ø 5 mm max.	All models	1	XY2CZ708	0.056
					10	XY2CZ718	0.550
 XY2CZ701	XY2C_620_CP0DA2016004	Cable end protectors	-	Cable Ø 3.2 mm	10	XY2CZ701	0.002
				Cable Ø 5 mm	10	XY2CZ704	0.010
 XY2CZ703 XY2CZ702 XY2CZ712	PF123288 PF123286 PF123289	End springs	-	XY2CJ and XY2CH	1	XY2CZ703	0.035
				XY2CE	1	XY2CZ702	0.080
				XY2CED	2	XY2CZ712 (1)	0.220

(1) An adjustment shim XY2CZ713 and 2 end springs XY2CZ712 are supplied with XY2CED switches.

DF601301

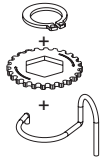

XY2CZ918

Mounting kits					
Kit contents	For use with	Cable diameter	Cable length	Reference	Weight
		mm	m		kg
1 spring + 1 notched washer + 1 circlip	XY2CH	–	–	XY2CZ918	0.010
1 galvanized cable + 1 cable grip XY2CZ523 + 1 end spring XY2CZ703	XY2CJ and XY2CH	3.2	10.5	XY2CZ9310	0.444
			15.5	XY2CZ9315	0.581
			20.5	XY2CZ9320	0.635
			30.5	XY2CZ9330	1.055
1 galvanized cable + 1 cable grip XY2CZ523 + 1 tensioner XY2CZ210 + 12 cable supports XY2CZ601 + 1 end spring XY2CZ703	XY2CJ	3.2	30.5	XY2CZ9425	2.045
1 galvanized cable + 4 cable grips XY2CZ524 + 1 turnbuckle XY2CZ404 + 11 cable supports XY2CZ601 + 2 cable end protectors XY2CZ704 + 1 end spring XY2CZ702	XY2CE	5	25.5	XY2CZ9525	1.853
1 galvanized cable + 4 cable grips XY2CZ524 + 1 turnbuckle XY2CZ404 + 19 cable supports XY2CZ601 + 2 cable end protectors XY2CZ704 + 1 end spring XY2CZ702	XY2CE	5	50.5	XY2CZ9550	3.240
1 galvanized cable + 4 cable grips XY2CZ524 + 1 turnbuckle XY2CZ404 + 26 cable supports XY2CZ601 + 2 cable end protectors XY2CZ704 + 1 end spring XY2CZ702	XY2CE	5	70.5	XY2CZ9570	4.426
2 galvanized cables + 2 cable grips XY2CZ524 + 2 quick tensioners XY2CZ213	XY2CED	5	2 x 50.5	XY2CZ96100	5.910
2 galvanized cables + 2 cable grips XY2CZ524 + 2 quick tensioners XY2CZ213	XY2CED	5	2 x 70.5	XY2CZ96140	8.080
2 galvanized cables + 2 cable grips XY2CZ524 + 2 quick tensioners XY2CZ213	XY2CED	5	2 x 100.5	XY2CZ96200	11.340

PF122061

XY2CZ96140
XY2CZ96200

Safety detection solutions

Emergency stop rope pull switches

Preventa XY2C

Replacement parts					
Description	For use with	Type	Reference	Weight kg	
Reset pushbutton (blue), spring return	XY2CE and XY2CED	Flush with "R" marked on push	ZB5AA639	0.018	
		Booted	ZB5AP6S	0.019	
		Mushroom head Ø 30	ZB5AC64	0.027	
Key switch	XY2CE and XY2CED	With key no. 421	ZB5AG612R26	0.064	
		With key no. 455	ZB5AG6R26	0.064	
Keys for reset button	XY2CH, XY2CE and XY2CED	No. 421	Q99900911	0.006	
		No. 455	Q99900901	0.006	
Pilot light head assemblies	XY2CE and XY2CED	Red	XY2CZ800	0.015	
		Orange	XY2CZ801	0.015	
Set of 5 cover gaskets	XY2CE and XY2CED	–	XY2CZ805	0.122	
Fixing nut, plastic, gray	XY2CE and XY2CED	–	ZB5AZ901	0.002	
Fixing nut tightening key, plastic, gray	XY2CE and XY2CED For fixing nut ZB5AZ901		ZB5AZ905	0.016	
Description	For use with	Voltage	Order in multiples of	Unit reference	Weight kg
Pilot lights With bulb DL1AA●●● included	XY2CH Color: orange	24 V ~/–	1	XY2CZ0024 (1)	0.035
		130 V ~/–	1	XY2CZ0130 (1)	0.035
		230 V ~/–	1	XY2CZ0230 (1)	0.035
Power LED	XY2CE and XY2CED Color: red	24 V ~/–	5	ZALVB4	0.015
		48 to 120 V ~	5	ZALVG4	0.015
		230 to 240 V ~	5	ZALVM4	0.015
	XY2CE and XY2CED Color: yellow	24 V ~/–	5	ZALVB5	0.015
		48 to 120 V ~	5	ZALVG5	0.015
		230 to 240 V ~	5	ZALVM5	0.015
Incandescent bulbs, screw base fitting	XY2CH	24 V - 6 W	10	DL1AA024	0.004
		130 V - 6 W	10	DL1AA127	0.004
		230 V - 6 W	10	DL1AA220	0.004
Set of 5 collars	For mounting bulbs DL1AA127 and DL1AA220 in pilot lights XY2CZ●●●	–	5	XY2CZ908	0.018

(1) Only for use as replacement parts on switches pre-equipped with pilot lights. CCC approval no longer applies if an XY2CZ●●● pilot light is mounted on XY2CH switches.

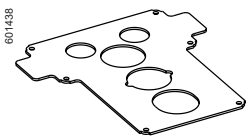

XY2CZ805

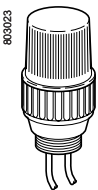

XY2CZ●●●

Emergency stop rope pull switches with single anchor point

XY2CJ

XY2CJS●●

XY2CJR●● and XY2CJL●● (same dimensions with anchor point on RH side or LH side)

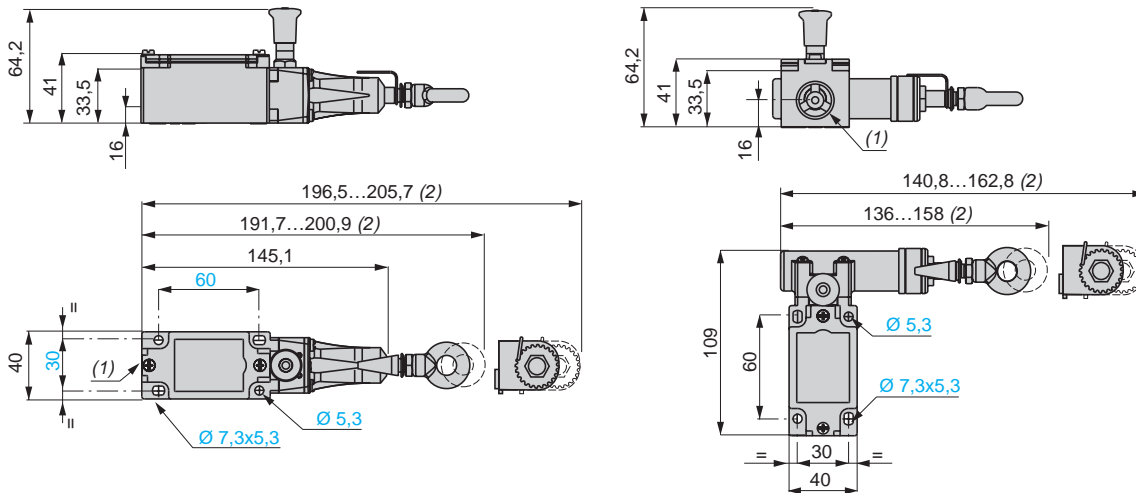

XY2CH

Without pilot light

With pilot light

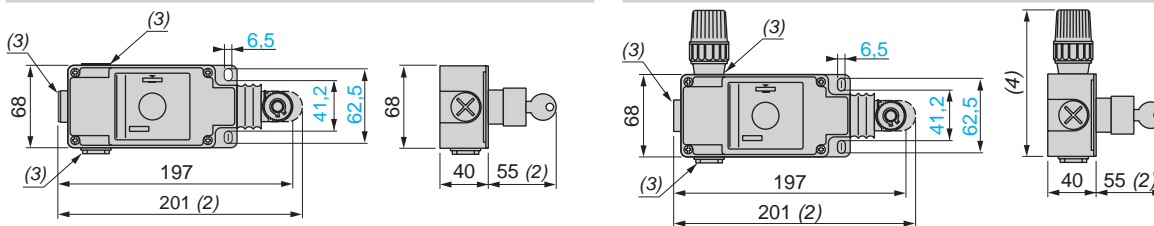

XY2CE

XY2CE1A●●● and XY2CE2A●●● (same dimensions with anchor point on RH side or LH side)

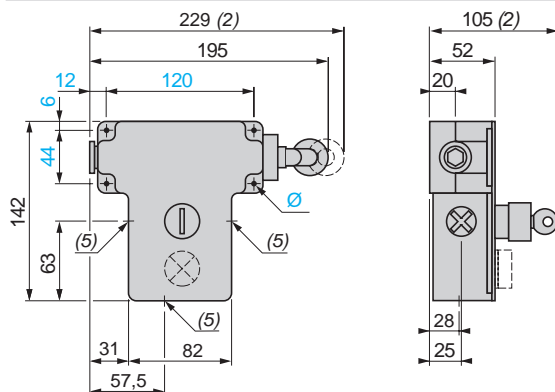

(1) Tapped entries for no. 13 cable gland (Pg 13.5). For ISO M20, the reference becomes XY2CJ●●●H29. For 1/2" NPT, the reference becomes XY2CJ●●●H7.

(2) Maximum extension.

(3) Tapped entries for no. 13 cable gland (Pg 13.5). For ISO M20, the reference becomes XY2CH●●●H29. For 1/2" NPT, the reference becomes XY2CH●●●H7.

(4) 121 mm: 24 V and 48 V versions. 131 mm: 130 V and 230 V versions.

(5) 3 untapped holes for no. 13 (Pg 13.5) or ISO M20 cable gland. For 1/2" NPT, the reference becomes XY2CE●●●H7 or XY2CED●●●H7.

Ø: 4 elongated holes Ø 6 mm.

Emergency stop rope pull switches with double anchor point

XY2CED

XY2CEDA●●● and XY2CEDC●●●

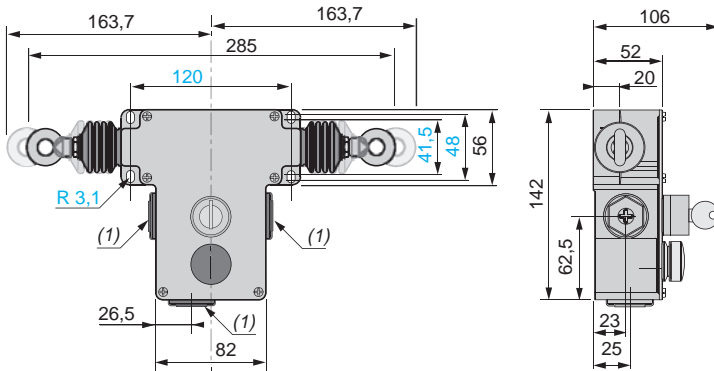

Accessories

Quick tensioners

XY2CZ213

XY2CZ210

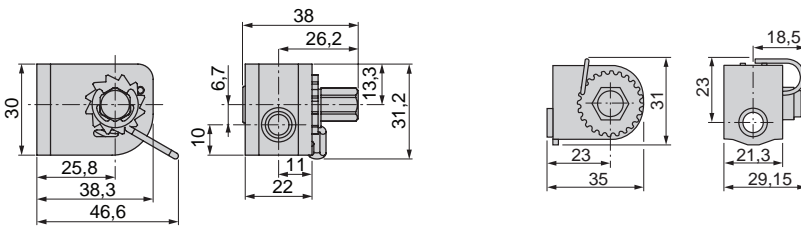

Cable and pulley supports

XY2CZ705

XY2CZ601

XY2CZ708

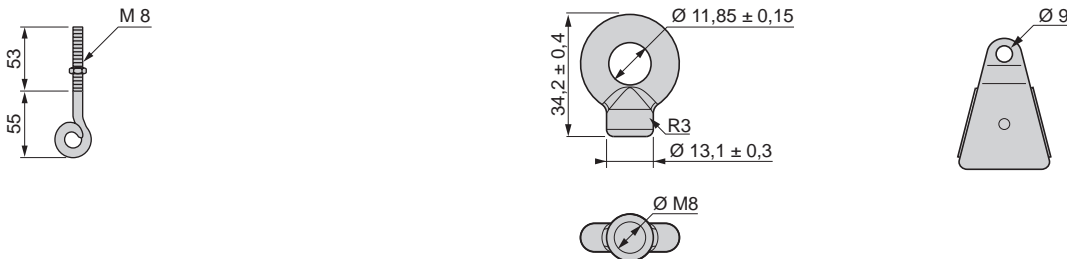

(1) 3 untapped holes for no. 13 (Pg 13.5) or ISO M20 cable gland. For 1/2" NPT, the reference becomes XY2CE●●●H7 or XY2CED●●●H7.

D			
DL1AA024	15	XY2CZ102	12
DL1AA127	15	XY2CZ105	12
DL1AA220	15	XY2CZ107	12
		XY2CZ110	12
		XY2CZ0130	15
Q		XY2CZ210	12
Q99900901	15	XY2CZ213	12
Q99900911	15	XY2CZ0230	15
		XY2CZ301	12
X		XY2CZ302	12
XY2CE1A150	10	XY2CZ303	12
XY2CE1A250	10	XY2CZ402	12
XY2CE1A270	10	XY2CZ403	12
XY2CE1A290	10	XY2CZ404	12
XY2CE1A296	10	XY2CZ503	13
XY2CE1A297	10	XY2CZ513	13
XY2CE1A450	10	XY2CZ523	13
XY2CE1A470	10	XY2CZ524	13
XY2CE2A150	10	XY2CZ601	13
XY2CE2A250	10	XY2CZ602	13
XY2CE2A270	10	XY2CZ611	13
XY2CE2A290	10	XY2CZ701	13
XY2CE2A296	10	XY2CZ702	13
XY2CE2A297	10	XY2CZ703	13
XY2CE2A450	10	XY2CZ704	13
XY2CE2A470	10	XY2CZ705	13
XY2CEDA190	11	XY2CZ708	13
XY2CEDA196	11	XY2CZ712	13
XY2CEDA197	11	XY2CZ713	12
XY2CEDA290	11	XY2CZ715	13
XY2CEDA296	11	XY2CZ718	13
XY2CEDA297	11	XY2CZ800	15
XY2CEDA590	11	XY2CZ801	15
XY2CEDA596	11	XY2CZ805	15
XY2CEDA597	11	XY2CZ908	15
XY2CEDC190	11	XY2CZ918	14
XY2CEDC290	11	XY2CZ1015	12
XY2CEDC296	11	XY2CZ3015	12
XY2CEDC297	11	XY2CZ3020	12
XY2CEDC590	11	XY2CZ9310	14
XY2CH13150	9	XY2CZ9315	14
XY2CH13170	9	XY2CZ9320	14
XY2CH13190	9	XY2CZ9330	14
XY2CH13250	9	XY2CZ9425	14
XY2CH13253	9	XY2CZ9525	14
XY2CH13270	9	XY2CZ9550	14
XY2CH13273	9	XY2CZ9570	14
XY2CH13290	9	XY2CZ96100	14
XY2CH13293	9	XY2CZ96140	14
XY2CH13350	9	XY2CZ96200	14
XY2CH13370	9		
XY2CH13390	9	Z	
XY2CH13450	9	ZALVB4	15
XY2CH13470	9	ZALVB5	15
XY2CJL15	8	ZALVG4	15
XY2CJL17	8	ZALVG5	15
XY2CJL19	8	ZALVM4	15
XY2CJR15	8	ZALVM5	15
XY2CJR17	8	ZB5AA639	15
XY2CJR19	8	ZB5AC64	15
XY2CJS15	8	ZB5AG6R26	15
XY2CJS17	8	ZB5AG612R26	15
XY2CJS19	8	ZB5AP6S	15
XY2CZ0024	15	ZB5AZ901	15
		ZB5AZ905	15