



DATA SHEET



# C 310

## CaptEUR multifonction

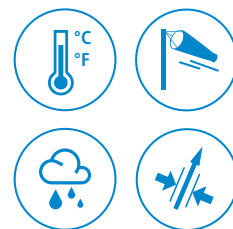

**2 inputs for interchangeable probes**



**2 analogue outputs (4 wires) 0/5-10 V or 0/4-20 mA\***



**4 visual (dual-color LEDs) and audible alarms**



**Simultaneous display of 1 to 4 parameters**

### Features

- 1 location for interchangeable SPI-2 board
- Trend indicator
- 4-relay board (optional)
- 24 Vdc/Vac or 115/230 Vac power supply
- Outputs diagnostic
- Ethernet communication (optional)
- MODBUS network RS485 system (optional)
- ABS housing with stainless steel front, IP65, with or without backlit graphic display
- "1/4 turn" system mounting with wall-mount plate

### Possible optional measurements

The following probes and boards are available as option for C310 transmitters. For further details please see the technical datasheet of probes for class 310 transmitters.

Probes and boards	Plages de mesure
Stainless steel or polycarbonate hygrometry / temperature probe	From 0 to 100%RH and from -40 to +180°C (according to probe)
Air velocity vane probe: air velocity / temperature / airflow	From -5 to 35 m/s (according to probe) From -20 to +80°C From 0 to 99 999 m³/h
Air velocity hotwire probe: air velocity / temperature / airflow	From 0 to 30 m/s From -20 to +80°C From 0 to 99 999 m³/h
Omnidirectional probe: air velocity / temperature	From 0 to 5 m/s and from 0 to 50°C
Pt100 1/3 DIN temperature probe	From -50 to +180°C / From -20 to +80°C
CO / temperature probe	From 0 to 500 ppm and from 0 to 50°C
CO <sub>2</sub> / temperature probe	From 0 to 20 000 ppm and from 0 to 50°C
Pressure / atmospheric pressure board	From -100 to +10 000 Pa (according to boards) / from 800 to 1100 hPa
Relays board	4 relays 3 A with 3-point terminal blocks



\*2 additional outputs (optional)

### Part number

Reference	Description
C310-BO	Multifunction transmitter, 24 Vac/Vdc power supply, with display
C310-BN	Multifunction transmitter, 24 Vac/Vdc power supply, without display
C310-HO	Multifunction transmitter, 115-230 Vac power supply, with display
C310-HN	Multifunction transmitter, 115-230 Vac power supply, without display



## General features

Power supply	24 Vac / Vdc $\pm$ 10% 100-240 Vac, 50-60 Hz
	Warning: risk of electric shock 
Outputs	2 x 0/4-20 mA or 2 x 0-5/10 V (4 wires) Optional additional outputs: 2 x 0/4-20 mA or 2 x 0-5/10 V (additional consumption for 24 V model: 1 VA / for 115-230 V model: 2 VA) Common mode voltage <30 VAC Maximum load: 500 Ohms (0/4-20 mA) Minimum load: 1 K Ohms (0-5/10 V)
Galvanic isolation	Inputs (power supply) and outputs (on 115 Vac/230 Vac models) Device fully protected by DOUBLE ISOLATION or REINFORCED ISOLATION  Outputs (on 24 Vac/Vdc models)
Consumption with probe and without option	C310-BO and C310-BN: 6 VA C310-HO and C310-HN: 8 VA (CO2 probe additional consumption for 24 V and 115-230 V models: 2 VA)
Raccordement électrique	Bornier à vis pour câbles de 0.05 à 2.5 mm <sup>2</sup> ou de 30 à 14 AWG ; Réalisé suivant les règles de l'art
Relays (optional)	4 RCR relays. NO: 5A / NC: 3A / 240 Vac (additional consumption for 24 V model: 5 VA / for 115-230 V model: 8 VA)
Communication RS485 (option)	Numérique : protocole Modbus RTU, vitesse de communication configurable de 2400 à 115200 Bauds
Communication Ethernet (option)	Module de communication Ethernet permettant la transmission, la supervision et la maintenance des capteurs au travers d'un réseau Ethernet en 10 BASE-T et 100 BASE-TX LAN/WAN supportant le protocole TCP/IP (consommation supplémentaire modèle 24 V et 115-240 V : 1 VA)
Audible alarm	Buzzer (70 dB at 10 cm)
Environment and type of fluid	Air and neutral gases
Conditions of use (°C/%RH/m)	From -10 to +50°C. In non-condensing condition. From 0 to 2000 m
Storage temperature	From -10 to +70°C
Security	Protection class 2; Pollution degree 2; Overvoltage category 2
European directives	2014/30/EU EMC; 2014/35/EU Low Voltage; 2011/65/EU RoHS II; 2012/19/EU WEEE

## Ethernet board (optional)

An Ethernet board can be put on a C 310 transmitter allowing for each transmitter to have a specific configurable IP address. So the user can remotely interrogate the transmitter, retrieve data, modify the configuration, ...

It is also possible to integrate C 310 transmitters into a computer network via the RJ45 connection located at the bottom of the transmitter.

## Modbus protocol (optional)

Class 310 transmitters can be linked in one network operating on a RS485 home bus.

The RS 485 digital communication is a 2-wire network, on which the transmitters are connected in parallel. They are connected to a PLC/BMS via the RTU Modbus communication system. Since the C310 can be configured with the keypad, the MODBUS enables remote configuration, to measure 1 or 2 parameters or to see the status of the alarms...

## Features of the housing

Material	ABS V0 as per UL94
Protection	IP65
Display	Graphic from 1 to 4 lines, 240 x 128 px; Size: 86 x 51 mm, Backlit Height of digits: Values: 10 mm; Units: 5 mm
Cable gland	In polyamide for cables Ø9 mm maximum
Weight	700 g

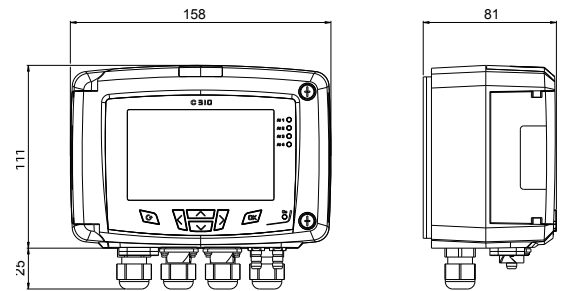

All dimensions are in millimeters.

## Relays and alarms

The C 310 transmitter has 4 independent and configurable alarms: these are visual and audible alarms and it is possible to couple them with 4 relays (optional).

### Available settings:

- Selection of the parameter (pressure, air velocity, temperature,...)
- Time-delays duration from 0 to 600 s
- Alarm action : rising edge, falling edge, monitoring or state of the transmitter
- Operating mode of the relays : negative or positive safety (optional)
- Activation of the audible alarm (buzzer) that can be acknowledged by the front keypad (optional)

# Connections

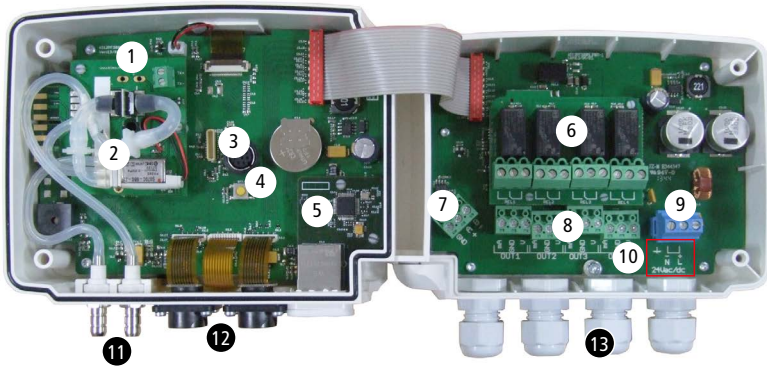

1. SPI-2 board (optional)
2. Solenoid valve
3. LCC-S software connection
4. Autozero
5. Ethernet board (optional)
6. Analogue outputs (a) (OUT3 and OUT4 are optional)
7. RS 485 connection(d) (optional)
8. Relays board (b) (optional)
9. Power supply terminal block (c)
10. Type of power supply of the transmitter
11. Pressure connection (optional)
12. Probes connection
13. Cable glands

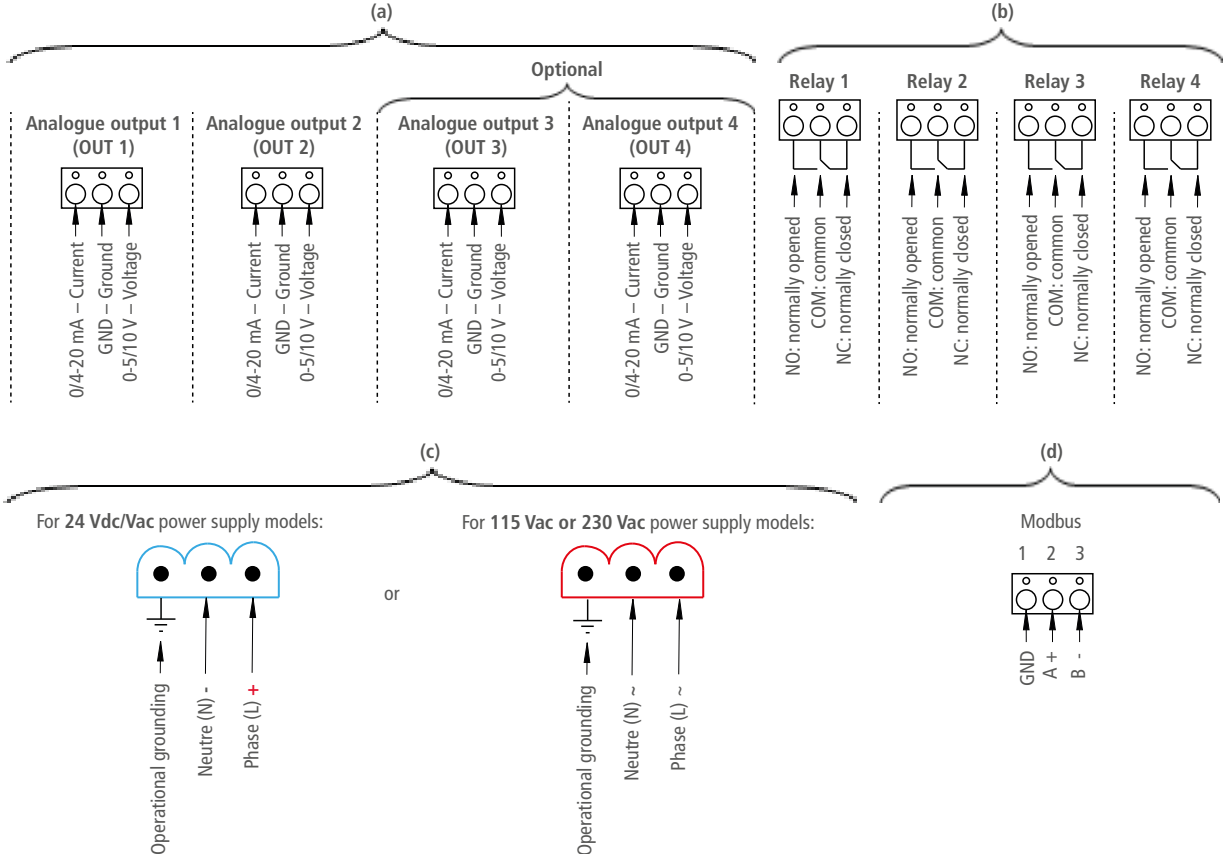

## Electrical connections as per NFC15-100 standard



This connection must be made by a formed and qualified technician. Whilst making the connection, the transmitter must not be energized. The presence of a switch or a circuit breaker upstream the device is compulsory.

- For 24 Vdc power supply models:
- For 115 Vac or 230 Vac power supply models:
- For 24 Vac power supply models:

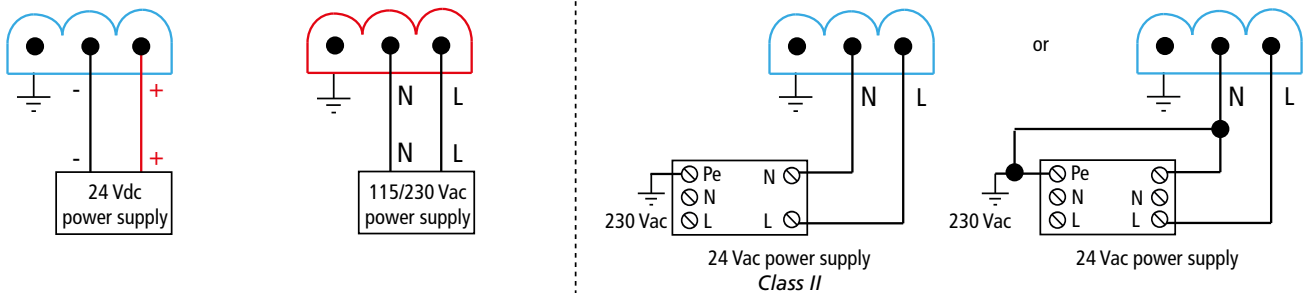

- 0/4-20 mA current output connection:

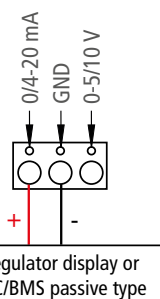

- 0-5/10 V voltage output connection:

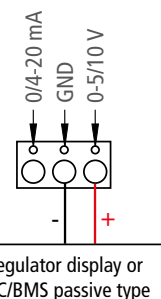

## Configuration

Class 310 transmitters allows you to set all the parameters managed by the transmitter : units, measuring ranges, alarms, outputs, channels... via the different methods shown below:

- **Via keypad, only on models with display.** A code-locking system for keypad guarantees the security of the installation. See configuration manual.
- **Via software (optional):** simple and user-friendly. See LCC-S user manual.
- **Via Modbus (optional):** configuration of all parameters from your PC, via the supervision or data acquisition software.
- **Via Ethernet (optional):** configuration of all parameters from your PC, via the supervision or data acquisition software.

## Mounting

To install the transmitter on a wall, fix the stainless steel plate to the wall (drilling: Ø8 mm, screws and wall-plugs supplied). Insert the transmitter on the plate (see A on the drawing below) by aligning it at 30°. Rotate the housing in clockwise direction until you heard a “click” which confirms that the transmitter is correctly installed. Open the housing, lock the clamping system of the housing on the plate with the screw (see photo below). To remove the transmitter from the fixing plate, do not forget to remove this screw.

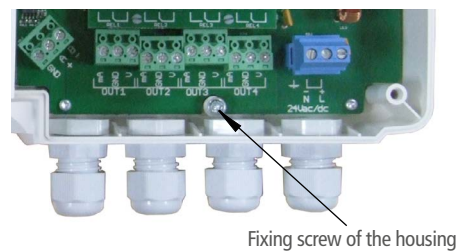
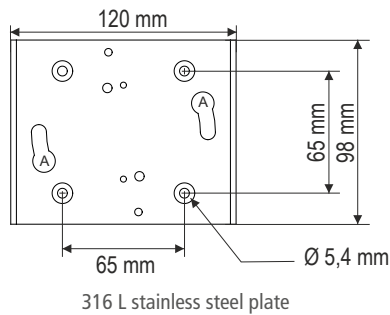

## Maintenance

Avoid aggressive solvents. When cleaning rooms or ducts with products containing formol, protect the the transmitter.

## Calibration

**Outputs diagnostics:** with this function, you can check with a multimeter (or on a regulator/display, or on a PLC/BMS) if the transmitter outputs work properly. The transmitter generates a voltage of 0 V, 5 V and 10 V or a current of 0 mA, 4 mA, 12 mA and 20 mA

**Certificate:** transmitters are supplied with an individual adjusting certificate and can be supplied with a calibration certificate as an option.

## Precautions for use

Please always use the device in accordance with its intended use and within parameters described in the technical features in order not to compromise the protection ensured by the device.

## Options and accessories

Name	Reference
Configuration software with USB cable	LCC-S
SQR/3 function: (square root extraction) function for the calculation of air velocity and airflow	-
Calibration certificate	-
RS 485 Protocol Modbus digital output	RS5
2 additional analogue outputs	O2S
4 relays board	C4R
Ethernet network board	CETHE
High resolution (example in pressure: 0.1 Pa) with SPI2-100 board	HRP



Only the accessories supplied with the device must be used.



A member of **sauermann®**