

Digital Fiber Sensor FX-100 SERIES

Related Information

- General terms and conditions..... F-3
- Selection guide P.3~
- Fiber selection..... P.5~
- Glossary of terms / General precautions..... P.1549~ / P.1552

- FIBER SENSORS
- LASER SENSORS
- PHOTOELECTRIC SENSORS
- MICRO PHOTOELECTRIC SENSORS
- AREA SENSORS
- SAFETY LIGHT CURTAINS / SAFETY COMPONENTS
- PRESSURE / FLOW SENSORS
- INDUCTIVE PROXIMITY SENSORS
- PARTICULAR USE SENSORS
- SENSOR OPTIONS
- SIMPLE WIRE-SAVING UNITS
- WIRE-SAVING SYSTEMS
- MEASUREMENT SENSORS
- STATIC CONTROL DEVICES
- LASER MARKERS
- PLC
- HUMAN MACHINE INTERFACES
- ENERGY MANAGEMENT SOLUTIONS
- FA COMPONENTS
- MACHINE VISION SYSTEMS
- UV CURING SYSTEMS

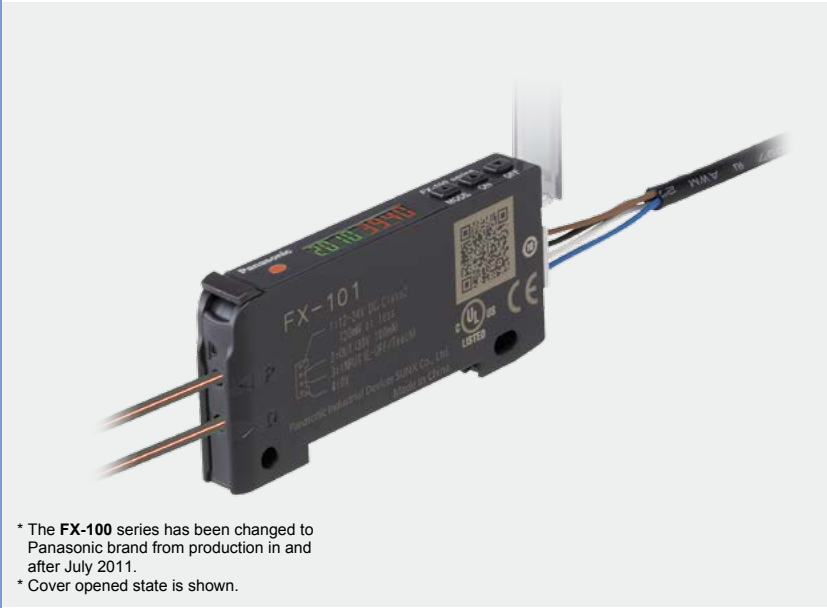

* The FX-100 series has been changed to Panasonic brand from production in and after July 2011.
* Cover opened state is shown.

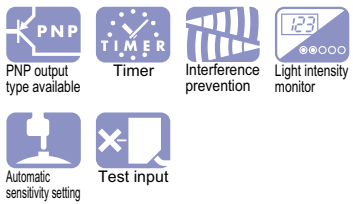

Taking fiber sensors to the next level

Good dual digital display

The threshold value and incident light intensity can be both confirmed at the same time, bringing good operability when making changes of each setting.



Commercially-available connectors reduce lead time and spare part numbers

Compatible with commercially-available connectors, so that processing costs and lead time required for processing after purchase can be greatly reduced. The connection parts same as the DP-100 series digital pressure sensors and the PM-65 series micro photoelectric sensors can be commonly used.



Commercially-available crimping connectors are used, so that the processing costs for connection cables can be greatly reduced.

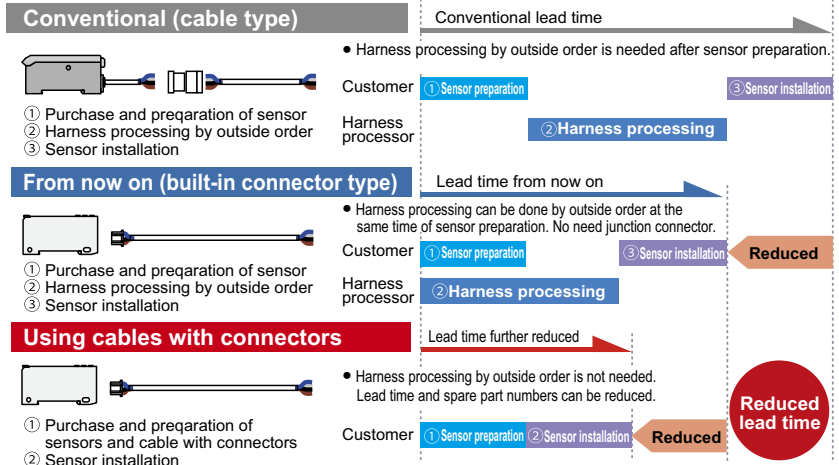

Saving-space with a width of 9 mm 0.354 in

Very slim body at only 9 mm 0.354 in. This is much thinner than existing fiber sensors. This makes a very large difference when using many units, even if the difference of one unit is small.

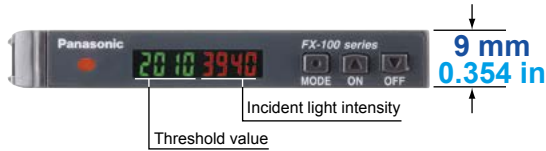

Improved stability over long terms

Utilizes "Four-chemical emitting element" for light emission. The light emission is guaranteed to be stable over long periods of time.

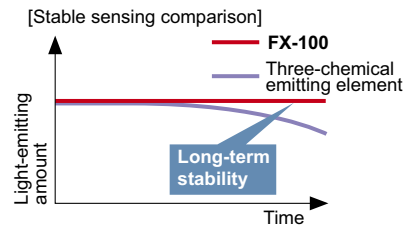

Simple operation due to clear configuration system

Continued to use the configuration system of digital pressure sensor **DP-100** series, which has received high popularity since its release. We have separated the settings into three levels: RUN mode, SET mode, and PRO mode, making operation simpler and easier.

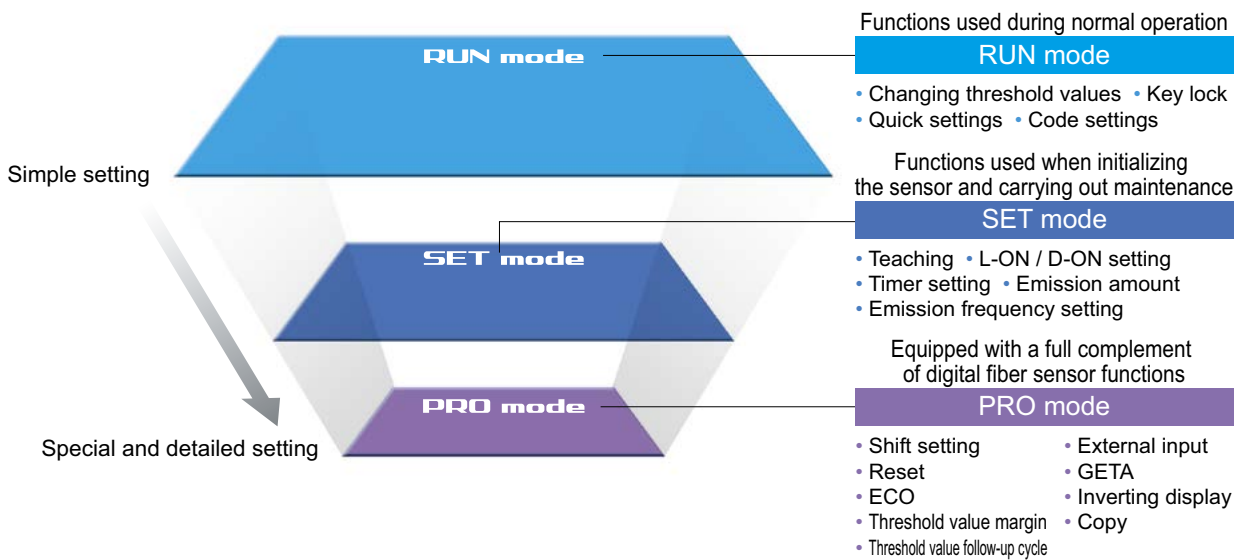

Quick code input function

Simply inputting the default setting "code (number)" will enable sensor settings. Even if the settings are accidentally changed, inputting the code will restore the default settings. Confirmation can be carried out smoothly via telephone by simply quoting numbers. This can be of great assistance when dealing with foreign country customers.



RUN mode



Quick setting: Press and simultaneously for 2 sec.

Code setting: Press and simultaneously for 4 sec.

Quick setting numbers (abstract)

No	Output operation	Timer	Emission amount setting
-00-	Dark-ON	None	OFF
-01-	Dark-ON	None	ON
-02-	Dark-ON	OFF-delay 10 ms	OFF
-03-	Dark-ON	OFF-delay 10 ms	ON
-10-	Light-ON	ON-delay 40 ms	ON
-11-	Light-ON	ON-delay 40 ms	OFF
-12-	Light-ON	ON-delay 10 ms	ON
-13-	Light-ON	ON-delay 10 ms	OFF

Refer to "Quick setting function" and "Code setting function" in "PRECAUTIONS FOR PROPER USE".

FIBER SENSORS

LASER SENSORS

PHOTOELECTRIC SENSORS

MICRO PHOTOELECTRIC SENSORS

AREA SENSORS

SAFETY LIGHT CURTAINS / SAFETY COMPONENTS

PRESSURE / FLOW SENSORS

INDUCTIVE PROXIMITY SENSORS

PARTICULAR USE SENSORS

SENSOR OPTIONS

SIMPLE WIRE-SAVING UNITS

WIRE-SAVING SYSTEMS

MEASUREMENT SENSORS

STATIC CONTROL DEVICES

LASER MARKERS

PLC

HUMAN MACHINE INTERFACES

ENERGY MANAGEMENT SOLUTIONS

FA COMPONENTS

MACHINE VISION SYSTEMS

UV CURING SYSTEMS

Selection Guide

Fibers

Fiber Amplifiers

Other Products

FX-500

FX-550

FX-100

FX-410

- FIBER SENSORS
- LASER SENSORS
- PHOTOELECTRIC SENSORS
- MICRO PHOTOELECTRIC SENSORS
- AREA SENSORS
- SAFETY LIGHT CURTAINS / SAFETY COMPONENTS
- PRESSURE / FLOW SENSORS
- INDUCTIVE PROXIMITY SENSORS
- PARTICULAR USE SENSORS
- SENSOR OPTIONS
- SIMPLE WIRE-SAVING UNITS
- WIRE-SAVING SYSTEMS
- MEASUREMENT SENSORS
- STATIC CONTROL DEVICES
- LASER MARKERS
- PLC
- HUMAN MACHINE INTERFACES
- ENERGY MANAGEMENT SOLUTIONS
- FA COMPONENTS
- MACHINE VISION SYSTEMS
- UV CURING SYSTEMS

Teaching with ON/OFF keys SET mode

Simply press the ON key when an object is present, and OFF when it is not, and teaching is completed. There is no need to consider difference between Light-ON and Dark-ON.

<Setting example>

Thru-beam type / Retroreflective type

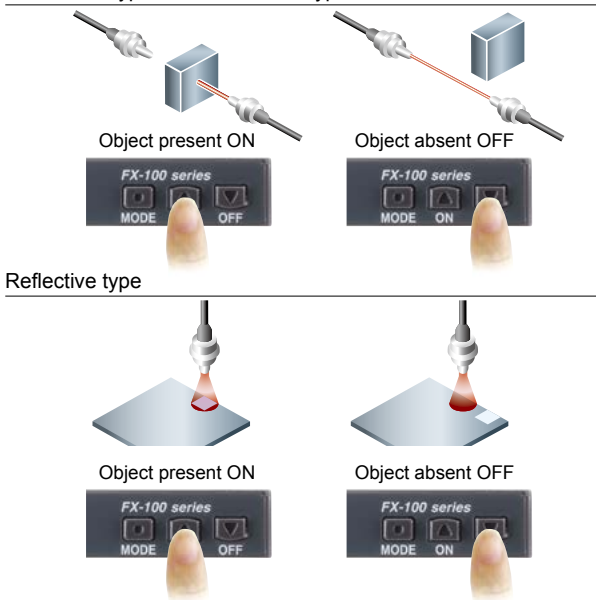

Teaching even without an object — Limit teaching function

Threshold value can be set by performing teaching only when an object is absent (when the incident light amount is stable). This is useful when there are other objects in the background also when defecting a minute objects. Teaching can also be carried out using external input.

Threshold value follow-up cycle setting function PRO mode

This function performs automatic setting to threshold value by checking the incident light intensity at desired intervals in order to follow the changes in the light amount resulting from changes in the environment over long periods (such as dust). Contributes to reduction in maintenance hours.

* Effective when the output operation is set to Dark-ON, and when using thru-beam type or retroreflective type fibers.

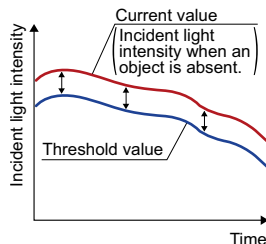

Resolves variation in incident light intensity display PRO mode

Even when performing the same sensing operation, there may be variances in the digital values of the fiber amp. There is no problem with the sensor itself, but the operator may find it troubling. Given value can be corrected with the GETA function, so the apparent variation can be eliminated and the creation of operation manuals can proceed smoothly.

Variations in the amount of light received



Unify at 500 using the GETA function

Example of current incident light intensity display of '500' is adjusted to '1000'

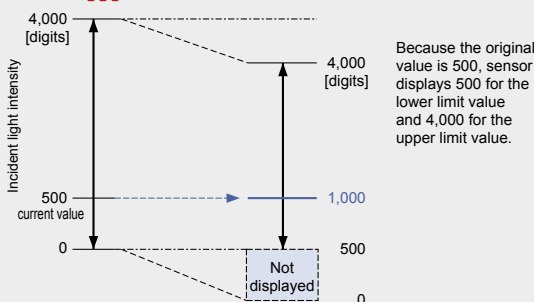

Emission amount setting function SET mode

Emission amount can be reduced in order to achieve stable detection when the receiving light level is saturated, such as detection at close range and detection of transparent or minute objects. Previously, the emission amount level was only one, but from production in December 2007, four level setting (three level + auto setting) has become available. This function brings easier settings than before.

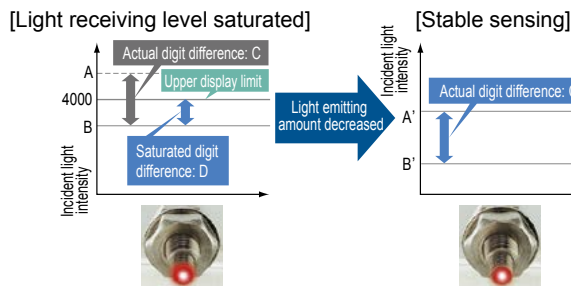

- Selection Guide
- Fibers
- Fiber Amplifiers
- Other Products
- FX-500
- FX-550
- FX-100
- FX-410

Emission frequency setting mode **SET mode**

Mutual interference is prevented for max. 3 units for standard type **FX-101** and max. 4 units in case of long sensing range type **FX-102**. During setting of interference prevention, emitter and output indicator both flash, so it is convenient to confirm which fiber is in the setting process at a glance. Emitter flashes even when an amplifier is not installed close together.

* When the emission frequency is changed, a response time is also changed.



External input setting mode **PRO mode**

External input can be selected from emission halt, limit teaching / full-auto teaching / 2-level teaching, ECO or emission amount test. Threshold value set at each teaching is also memorized.

* 2-level teaching, emission amount test and threshold value storing setting are available in amplifiers manufactured after December 2007.

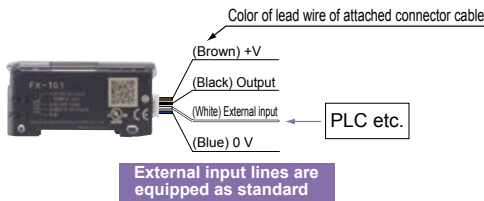

Digital display inversion setting **PRO mode**

The viewing orientation of the digital display can be inverted in accordance with the setting direction of the amplifier.

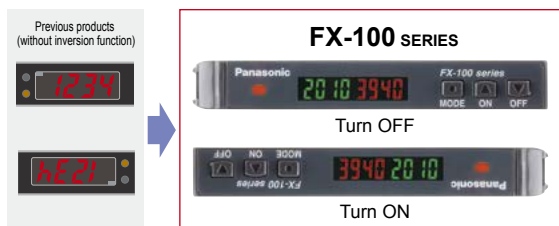

Alert function **PRO mode**

When the amount light received approaches the threshold value, the display can be made to blink in order to alert the operator.

<When using at a shift amount of 20% and a threshold value of 1,000>
The amount of light received ranges from about 900 to 1,100 when the digital indicator flashes.

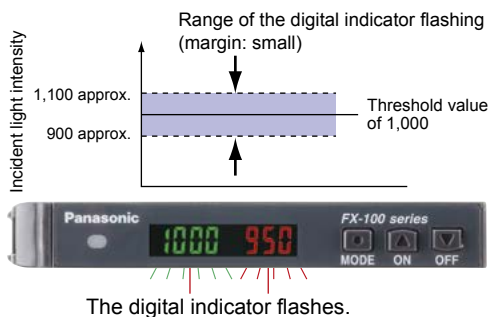

Setting copy function to reduce man-hours and human error **PRO mode**

By connecting a fiber sensor to the master fiber sensor, the master sensor settings can be copied along with data communications. When the same settings are input to several units, trouble from setting errors can be prevented, also changes to the work order will be small when equipment design is changed.

<Wiring to copy settings>

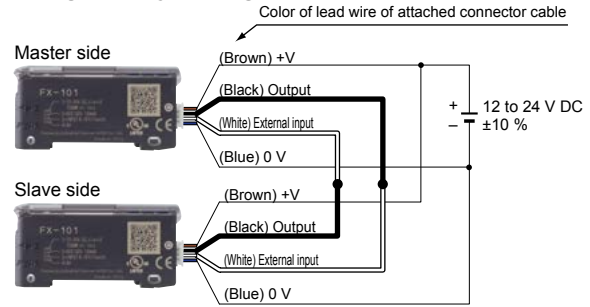

These settings can be copied

Threshold value, output operation, timer operation, timer emission amount, shift, external input, threshold value-storing, ECO inverting digital display, and threshold value margin

Without mounting bracket

Selectable either mounting on DIN rail or direct mounting with through hole. Direct mounting brings stability even on a movable parts or installation of a single unit.



Available from standard type or long sensing range type

Standard type and long sensing range type are available which has various response time and sensing range. The model best meet application needs can be selected.

Model No.	Type	Sensing range (FT-43)	Response time
FX-101	Standard type	350 mm 13.780 in	Max. 250 μs
FX-102	Long sensing range type	970 mm 38.189 in	Max. 2.5 ms

Power consumption saving with ECO mode

When there is no key operations in approximately 20 seconds, digital display turns off and power consumption can be reduced to 600 mW or less (720 mW in normal mode).

FIBER SENSORS

LASER SENSORS

PHOTOELECTRIC SENSORS

MICRO PHOTOELECTRIC SENSORS

AREA SENSORS

SAFETY LIGHT CURTAINS / SAFETY COMPONENTS

PRESSURE / FLOW SENSORS

INDUCTIVE PROXIMITY SENSORS

PARTICULAR USE SENSORS

SENSOR OPTIONS

SIMPLE WIRE-SAVING UNITS

WIRE-SAVING SYSTEMS

MEASUREMENT SENSORS

STATIC CONTROL DEVICES

LASER MARKERS

PLC

HUMAN MACHINE INTERFACES

ENERGY MANAGEMENT SOLUTIONS

FA COMPONENTS

MACHINE VISION SYSTEMS

UV CURING SYSTEMS

Selection Guide

Fibers

Fiber Amplifiers

Other Products

FX-500



FX-550

FX-100

FX-410

ORDER GUIDE

Amplifiers

Type	Appearance	Model No.	Emitting element	Output
Standard type		FX-101 (Note 2)	Red LED	NPN open-collector transistor
		FX-101-Z (Note 3)		NPN open-collector transistor
		FX-101P (Note 2)		PNP open-collector transistor
		FX-101P-Z (Note 3)		PNP open-collector transistor
		FX-101-CC2		NPN open-collector transistor
		FX-101P-CC2		PNP open-collector transistor
Long sensing range type		FX-102 (Note 2)		NPN open-collector transistor
		FX-102-Z (Note 3)		NPN open-collector transistor
		FX-102P (Note 2)		PNP open-collector transistor
		FX-102P-Z (Note 3)		PNP open-collector transistor
		FX-102-CC2		NPN open-collector transistor
		FX-102P-CC2		PNP open-collector transistor

Accessory

- **CN-14A-C2**
(Connector attached cable 2 m 6.562 ft)
* Only include cable set type



- **FC-FX-1** (Protection cover)
* It have been attached from the production at July, 2011.

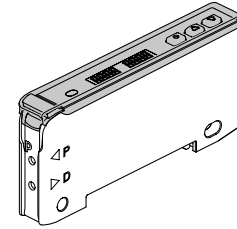

Notes: 1) The connector attached cable 2 m 6.562 ft **CN-14A-C2** is supplied with the amplifier.
 2) Make sure to use the optional connector attached cable **CN-14A(-R)-C□** or the connector **CN-14A**, or a connector manufactured by J.S.T. Mfg. Co., Ltd. (contact: SPHD-001T-P0.5, housing: PAP-04V-S)
 3) Make sure to use the optional M8 connector attached cable **CN-24A-C□**.

OPTIONS

Designation	Model No.	Description
Connector attached cable	CN-14A-C1	1 m 3.281 ft
	CN-14A-C2 (Note)	2 m 6.562 ft
	CN-14A-C3	3 m 9.843 ft
	CN-14A-C5	5 m 16.404 ft
Connector attached cable (Bending-resistant type)	CN-14A-R-C1	1 m 3.281 ft
	CN-14A-R-C2	2 m 6.562 ft
	CN-14A-R-C3	3 m 9.843 ft
	CN-14A-R-C5	5 m 16.404 ft
M8 connector attached cable	CN-24A-C2	2 m 6.562 ft
	CN-24A-C5	5 m 16.404 ft
Connector	CN-14A	Set of 10 housings and 40 contacts
Amplifier mounting bracket	MS-DIN-4	Mounting bracket for amplifier
End plates	MS-DIN-E	When an amplifier moves depending on the way it is installed on a DIN rail, these end plates clamp amplifiers into place on both sides.

Note: The connector attached cable **CN-14A-C2** is supplied with the cable set type **FX-10□-CC2**.

Recommended connector

Contact: SPHD-001T-P0.5, Housing: PAP-04V-S (Manufactured by J.S.T. Mfg. Co., Ltd.)
 Note: Contact the manufacturer for details of the recommended products.

Recommended crimping tool

Model No.: YC-610R (Manufactured by J.S.T. Mfg. Co., Ltd.)
 Note: Contact the manufacturer for details of the recommended products.

M8 connector attached cable

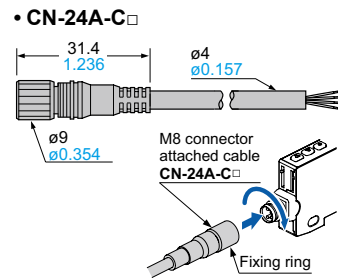

Amplifier mounting bracket

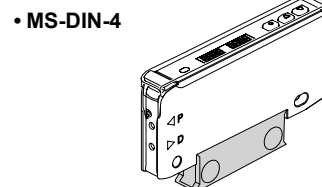

Connector attached cable

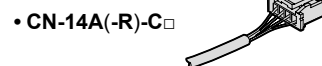

Connector

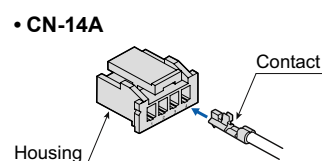

SPECIFICATIONS

Item	Model No.	Type	Standard type		Long sensing range type	
				Cable set		Cable set
		NPN output	FX-101(-Z) (Note 5)	FX-101-CC2	FX-102(-Z) (Note 5)	FX-102-CC2
		PNP output	FX-101P(-Z) (Note 5)	FX-101P-CC2	FX-102P(-Z) (Note 5)	FX-102P-CC2
CE marking directive compliance			EMC Directive, RoHS Directive			
Supply voltage			12 to 24 V DC ±10 % Ripple P-P 10 % or less			
Power consumption			Normal operation: 720 mW or less (Current consumption 30 mA or less at 24 V supply voltage) ECO mode: 600 mW or less (Current consumption 25 mA or less at 24 V supply voltage)			
Output			<NPN output type> NPN open-collector transistor • Maximum sink current: 100 mA • Applied voltage: 30 V DC or less (between output and 0 V) • Residual voltage: 1.5 V or less (at 100 mA sink current)		<PNP output type> PNP open-collector transistor • Maximum source current: 100 mA • Applied voltage: 30 V DC or less (between output and +V) • Residual voltage: 1.5 V or less (at 100 mA source current)	
Output operation			Selectable either Light-ON or Dark-ON, at SET mode			
Short-circuit protection			Incorporated			
External input			<NPN output type> NPN non-contact input • Signal condition High: +8 V to +V DC or Open Low: 0 to +2 V DC (Source current 0.5 mA or less) • Input impedance: 10 kΩ approx.		<PNP output type> PNP non-contact input • Signal condition High: +4 V to +V DC (Sink current 0.5 to 3 mA) Low: 0 to +0.6 V DC or Open • Input impedance: 10 kΩ approx.	
Response time			Emission frequency 0: 250 μs or less (factory default setting) Emission frequency 1: 450 μs or less Emission frequency 2: 500 μs or less Emission frequency 3: 600 μs or less		Emission frequency 1: 2.5 ms or less (factory default setting) Emission frequency 2: 2.8 ms or less Emission frequency 3: 3.2 ms or less Emission frequency 4: 5.0 ms or less	
Sensitivity setting			2-point teaching / Limit teaching / Full-auto teaching			
Operation indicator			Orange LED (lights up when the output is ON)			
Digital display			4 digits (green) + 4 digits (red) LCD display			
Fine sensitivity adjustment function			Incorporated			
Timer function			ON-delay/OFF-delay timer, switchable either effective or ineffective [Timer period: 1 ms, 5 ms, 10 ms, 20 ms, 40 ms, 50 ms, 100 ms, 500 ms, 1,000 ms]			
Emission amount setting function			3-level + Auto setting (from production in December 2007)			
Interference prevention function			Incorporated Emission frequency selection method (Note 2) (Functions at emission frequency 1, 2 or 3)		Incorporated Emission frequency selection method (Note 2) (Functions at emission frequency 1, 2, 3 or 4)	
Environmental resistance	Ambient temperature		-10 to +55 °C +14 to +131 °F (if 4 to 7 units are mounted close together: -10 to +50 °C +14 to +122 °F , if 8 to 16 units are mounted close together: -10 to +45 °C +14 to +113 °F) (No dew condensation or icing allowed), Storage: -20 to +70 °C -4 to +158 °F			
	Ambient humidity		35 to 85 % RH, Storage: 20 to 85 % RH			
	Ambient illuminance		Incandescent light: 3,000 lx or less at the light-receiving face			
	Voltage withstandability		1,000 V AC for one min. between all supply terminals connected together and enclosure (Note 3)			
	Insulation resistance		20 MΩ, or more, with 250 V DC megger between all supply terminals connected together and enclosure (Note 3)			
	Vibration resistance		10 to 150 Hz frequency, 0.75 mm 0.030 in double amplitude in X, Y and Z directions for two hours each			
	Shock resistance		98 m/s ² acceleration (10 G approx.) in X, Y and Z directions five times each			
Emitting element (modulated)			Red LED (Peak emission wavelength: 643 nm 0.025 mil)			
Material			Enclosure: Polycarbonate, Key switch: Polycarbonate, Fiber lock lever: PBT			
Connecting method			Connector (Note 4)			
Cable length			Total length up to 100 m 328.084 ft is possible with 0.3 mm ² , or more, cable.			
Weight			Net weight: 15 g approx. Gross weight: 35 g approx.	Net weight: 15 g approx. Gross weight: 75 g approx.	Net weight: 15 g approx. Gross weight: 35 g approx.	Net weight: 15 g approx. Gross weight: 75 g approx.
Accessory			FC-FX-1 (Protection cover): 1 pc. (Note 6)	FC-FX-1 (Protection cover): 1 pc. (Note 6) CN-14A-C2 (Connector attached cable, 2 m 6.562 ft long): 1 pc.	FC-FX-1 (Protection cover): 1 pc. (Note 6)	FC-FX-1 (Protection cover): 1 pc. (Note 6) CN-14A-C2 (Connector attached cable, 2 m 6.562 ft long): 1 pc.

- Notes: 1) Where measurement conditions have not been specified precisely, the conditions used were an ambient temperature of +23 °C **+73.4 °F**.
 2) When using the interference prevention function, set the emission frequencies for the amplifiers to be covered by the interference prevention function to different frequency values.
 However, the interference prevention function does not operate at emission frequency 0 (factory default setting) for the **FX-101(P)(-Z)** / **FX-101(P)-CC2**.
 3) The voltage withstandability and the insulation resistance values given in the above table are for the amplifier only.
 4) Connector attached cable **CN-14A-C2** is not attached to the models that have no **"-CC2"** at the end of the model Nos.
 Make sure to use the optional connector attached cable **CN-14A(-R)-C□** or the connector **CN-14A**, or a connector manufactured by J.S.T. Mfg., Ltd. (contact: SPHD-001T-P0.5, housing: PAP-04V-S).
 5) Model Nos. having the suffix **"-Z"** are M8 plug-in connector type. Make sure to use the optional M8 attached connector cable **CN-24A-C□**.
 6) Protection cover **FC-FX-1** has been attached from production in July, 2011.

LIST OF FIBERS

Refer to "Fiber Selection p.5 ~" for details of each fiber.

FIBER SENSORS

LASER SENSORS

PHOTO-ELECTRIC SENSORS

MICRO PHOTO-ELECTRIC SENSORS

AREA SENSORS

SAFETY LIGHT CURTAINS / SAFETY COMPONENTS

PRESSURE / FLOW SENSORS

INDUCTIVE PROXIMITY SENSORS

PARTICULAR USE SENSORS

SENSOR OPTIONS

SIMPLE WIRE-SAVING UNITS

WIRE-SAVING SYSTEMS

MEASUREMENT SENSORS

STATIC CONTROL DEVICES

LASER MARKERS

PLC

HUMAN MACHINE INTERFACES

ENERGY MANAGEMENT SOLUTIONS

FA COMPONENTS

MACHINE VISION SYSTEMS

UV CURING SYSTEMS

Selection Guide

Fibers

Fiber Amplifiers

Other Products

FX-500

FX-550

FX-100

FX-410

FIBER SENSORS
 LASER SENSORS
 PHOTO-ELECTRIC SENSORS
 MICRO PHOTO-ELECTRIC SENSORS
 AREA SENSORS
 SAFETY LIGHT CURTAINS / SAFETY COMPONENTS
 PRESSURE / FLOW SENSORS
 INDUCTIVE PROXIMITY SENSORS
 PARTICULAR USE SENSORS
 SENSOR OPTIONS
 SIMPLE WIRE-SAVING UNITS
 WIRE-SAVING SYSTEMS
 MEASUREMENT SENSORS
 STATIC CONTROL DEVICES
 LASER MARKERS
 PLC
 HUMAN MACHINE INTERFACES
 ENERGY MANAGEMENT SOLUTIONS
 FA COMPONENTS
 MACHIN VISION SYSTEMS
 UV CURING SYSTEMS
 Selection Guide
 Fibers
 Fiber Amplifiers
 Other Products
FX-500
FX-550
FX-100
FX-410

I/O CIRCUIT AND WIRING DIAGRAMS

FX-100(-Z/-CC2)

NPN output type

I/O circuit diagram

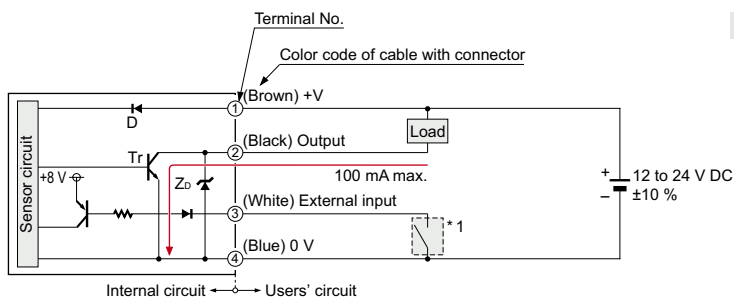

Symbols ... D : Reverse supply polarity protection diode
 ZD: Surge absorption zener diode
 Tr : NPN output transistor

* 1

Non-voltage contact or NPN open-collector transistor

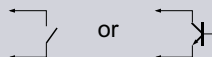

High (+8 V to +V DC, or open): Ineffective
 Low [0 to +2 V DC (source current 0.5 mA or less)]: Effective

Terminal arrangement diagram

Connector type

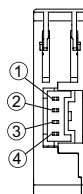

Terminal No.	Function
①	+V
②	Output
③	External input
④	0 V

M8 plug-in connector type

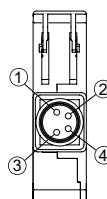

Terminal No.	Function
①	+V
②	Output
③	External input
④	0 V

FX-100P(-Z/-CC2)

PNP output type

I/O circuit diagram

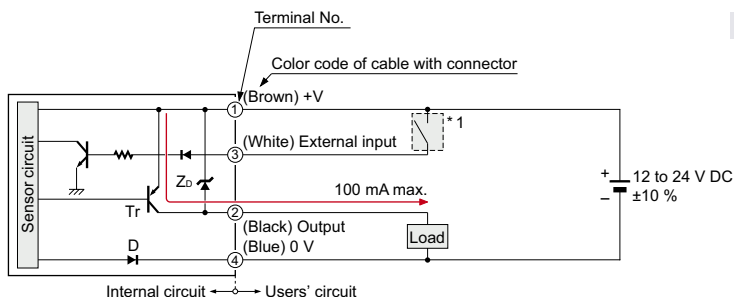

Symbols ... D : Reverse supply polarity protection diode
 ZD: Surge absorption zener diode
 Tr : PNP output transistor

* 1

Non-voltage contact or PNP open-collector transistor

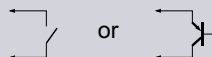

High [+4 V to +V DC (sink current 0.5 to 3 mA)]: Effective
 Low (0 to +0.6 V DC, or open): Ineffective

Terminal arrangement diagram

Connector type

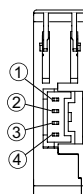

Terminal No.	Function
①	+V
②	Output
③	External input
④	0 V

M8 plug-in connector type

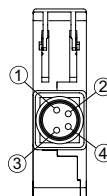

Terminal No.	Function
①	+V
②	Output
③	External input
④	0 V

SENSING CHARACTERISTICS (TYPICAL)

Contact our office for sensing characteristics that are not contained here.

FIBER SENSORS

LASER SENSORS

PHOTO-ELECTRIC SENSORS

MICRO PHOTO-ELECTRIC SENSORS

AREA SENSORS

SAFETY LIGHT CURTAINS / SAFETY COMPONENTS

PRESSURE / FLOW SENSORS

INDUCTIVE PROXIMITY SENSORS

PARTICULAR USE SENSORS

SENSOR OPTIONS

SIMPLE WIRE-SAVING UNITS

WIRE-SAVING SYSTEMS

MEASUREMENT SENSORS

STATIC CONTROL DEVICES

LASER MARKERS

PLC

HUMAN MACHINE INTERFACES

ENERGY MANAGEMENT SOLUTIONS

FA COMPONENTS

MACHINE VISION SYSTEMS

UV CURING SYSTEMS

Selection Guide

Fibers

Fiber Amplifiers

Other Products

FX-500

FX-550

FX-100

FX-410

FT-31S Thru-beam type

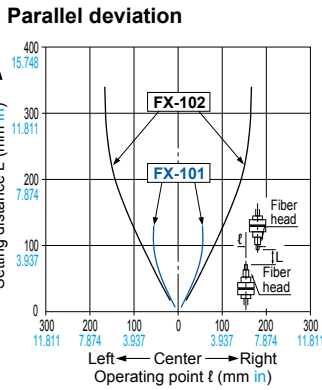

FT-31W Thru-beam type

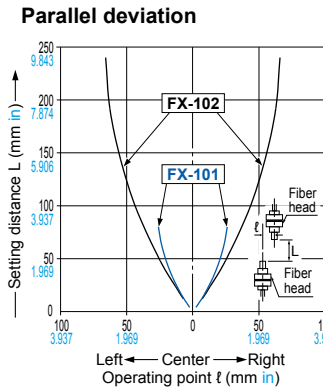

FT-42S Thru-beam type

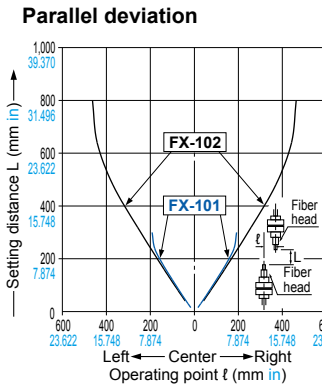

FT-42W Thru-beam type

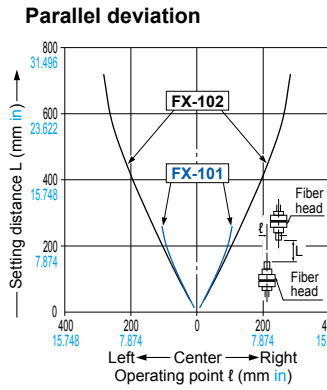

FT-43 Thru-beam type

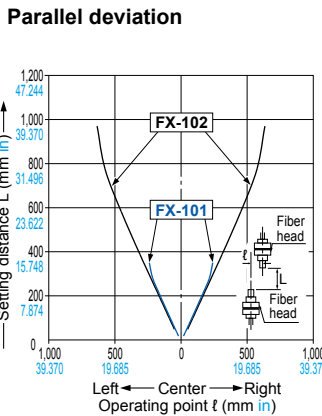

FT-45X Thru-beam type

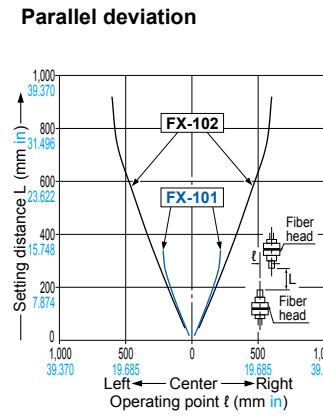

FT-A11 Thru-beam type

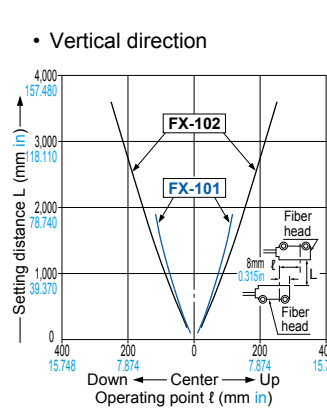
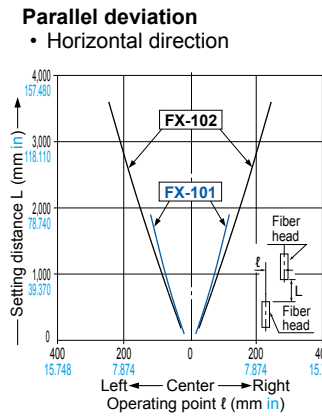

FT-S21W Thru-beam type

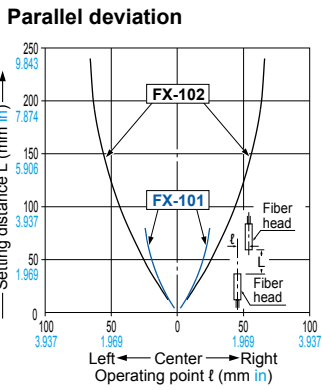

FT-S31W Thru-beam type

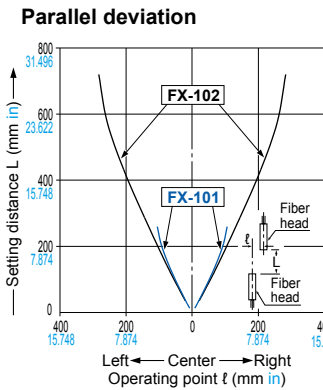

FD-32G Reflective type

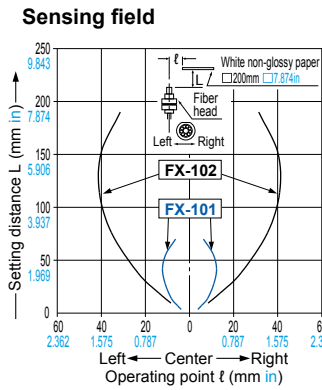

FD-32GX Reflective type

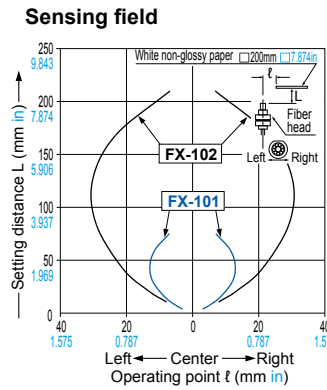

FD-41S Reflective type

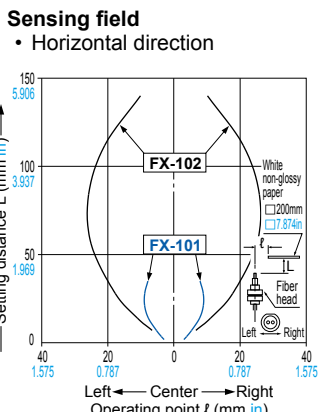

FD-41W Reflective type

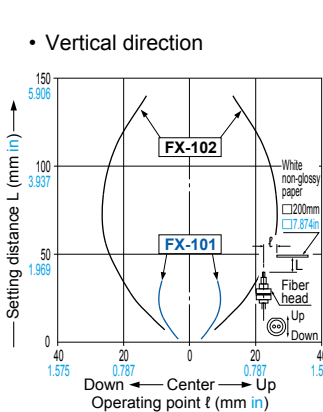

FD-41W Reflective type

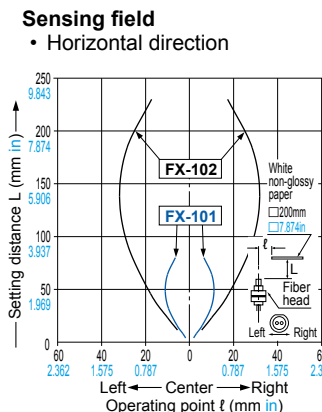

FD-41W Reflective type

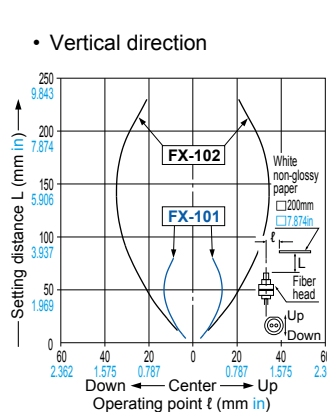

SENSING CHARACTERISTICS (TYPICAL)

Contact our office for sensing characteristics that are not contained here.

FIBER SENSORS
LASER SENSORS
PHOTO-ELECTRIC SENSORS
MICRO PHOTO-ELECTRIC SENSORS
AREA SENSORS
SAFETY LIGHT CURTAINS / SAFETY COMPONENTS
PRESSURE / FLOW SENSORS
INDUCTIVE PROXIMITY SENSORS
PARTICULAR USE SENSORS

SENSOR OPTIONS
SIMPLE WIRE-SAVING UNITS
WIRE-SAVING SYSTEMS
MEASUREMENT SENSORS
STATIC CONTROL DEVICES
LASER MARKERS
PLC
HUMAN MACHINE INTERFACES
ENERGY MANAGEMENT SOLUTIONS

FA COMPONENTS
MACHINE VISION SYSTEMS
UV CURING SYSTEMS
Selection Guide
Fibers
Fiber Amplifiers
Other Products

FX-500
FX-550
FX-100
FX-410

FD-42G Reflective type

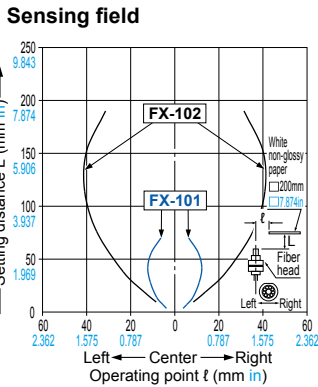

FD-42GW Reflective type

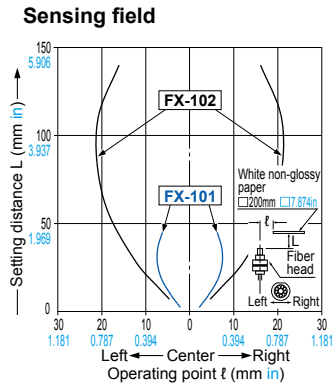

FD-61G Reflective type

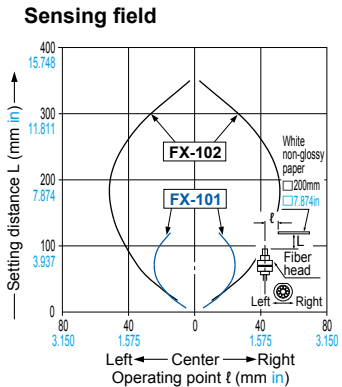

FD-61W Reflective type

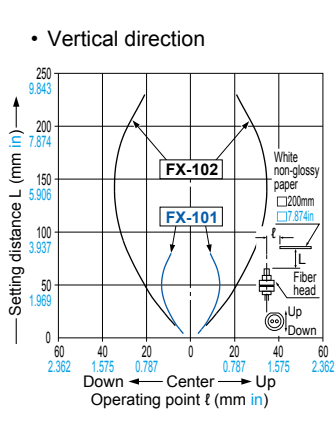
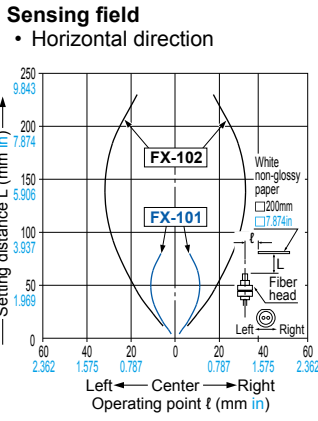

FD-62 Reflective type

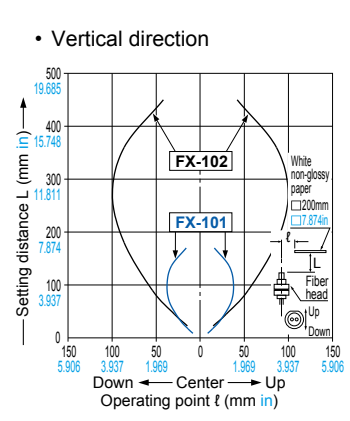
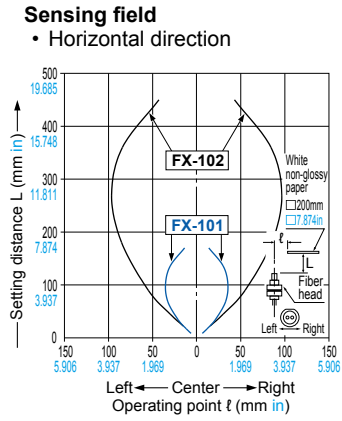

FD-64X Reflective type

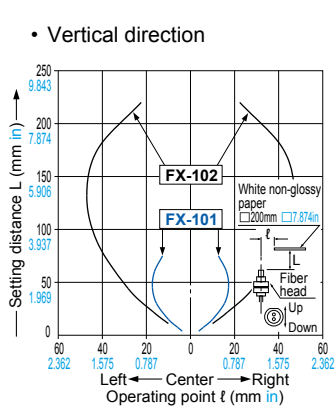
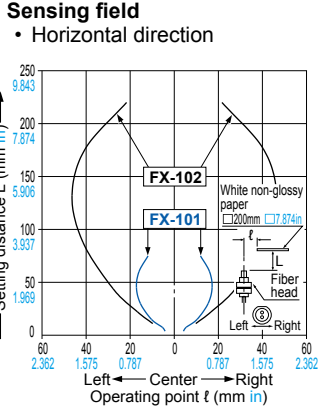

FD-S32W Reflective type

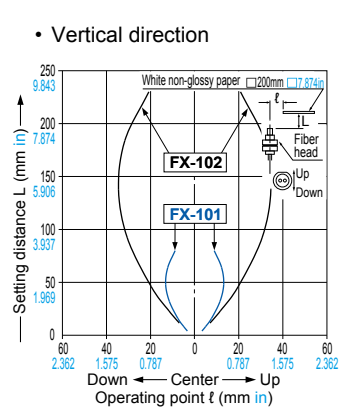
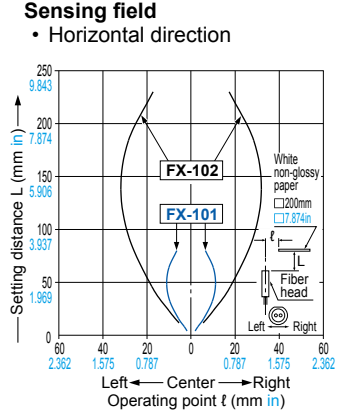

FD-S33GW Reflective type

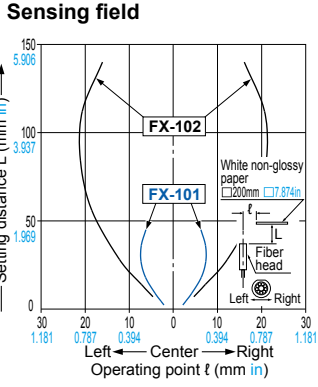

PRECAUTIONS FOR PROPER USE



- Never use this product as a sensing device for personnel protection.
- In case of using sensing devices for personnel protection, use products which meet laws and standards, such as OSHA, ANSI or IEC etc., for personnel protection applicable in each region or country.

Using in combination with the FX-300 / FX-410 series

- The **FX-100** series does not use the horizontal connectors that are used with the **FX-300 / FX-410** series. Please note that horizontal connection cannot be performed using a connector attached cable. In addition, the optical communication function is not equipped on the **FX-100** series, so it is unable to perform interference prevention for use with the **FX-300 / FX-410** series. If using the **FX-100** series together with the **FX-300 / FX-410** series side-by-side, please set the same models together in groups.

Mounting

<When using a DIN rail>

How to mount the amplifier

- ① Fit the rear part of the mounting section of the amplifier on a 35 mm **1.378 in** width DIN rail.
- ② Press down the rear part of the mounting section of the unit on the 35 mm **1.378 in** width DIN rail and fit the front part of the mounting section to the DIN rail.

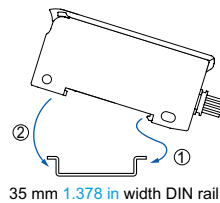

How to remove the amplifier

- ① Push the amplifier forward.
- ② Lift up the front part of the amplifier to remove it.

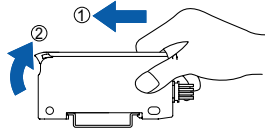

Note: Take care that if the front part is lifted without pushing the amplifier forward, the hook on the rear portion of the mounting section is likely to break.

<When using screws with washers>

- Use M3 screws with washers for mounting. The tightening torque should be 0.5 N·m or less.

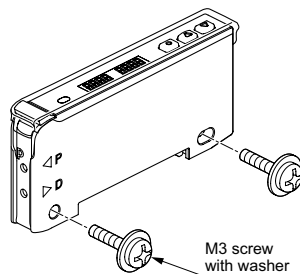

Refer to p.1552 ~ for general precautions.
Refer to General precautions, and to the "Operation Guide" on our website for details pertaining to operating instructions for the amplifier.

Wiring

- Make sure that the power supply is OFF while adding or removing the amplifiers.
- Note that if a voltage exceeding the rated range is applied, or if an AC power supply is directly connected, the product may get burnt or damaged.
- Note that short-circuit of the load or wrong wiring may burn or damage the product.
- Do not run the wires together with high-voltage lines or power lines, or put them in the same raceway. This can cause malfunction due to induction.
- Verify that the supply voltage variation is within the rating.
- If power is supplied from a commercial switching regulator, ensure that the frame ground (F.G.) terminal of the power supply is connected to an actual ground.
- In case noise generating equipment (switching regulator, inverter motor, etc.) is used in the vicinity of this product, connect the frame ground (F.G.) terminal of the equipment to an actual ground.
- Make sure to use the quick-connection cable (optional) for the connection of the controller.
Extension up to total 100 m **328.084 ft** is possible with 0.3 mm² or more, cable. However, in order to reduce noise, make the wiring as short as possible.

Part description

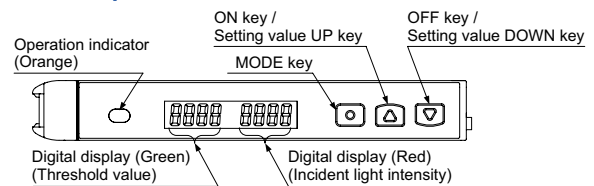

Setting mode

- Setting mode appears after the MODE key is pressed for 2 sec. in RUN mode.

Setting item	Factory setting	Description
Teaching mode	LRch	Threshold value can be set in 2-point teaching, limit teaching, or full-auto teaching.
Output operation setting	L_d d_on [Dark-ON]	Light-ON or Dark-ON can be set.
Timer operation setting	dELy non [Without timer]	Without timer, ON delay timer, or OFF delay timer can be set.
Timer delays setting	ond 10 [ON-delay timer: 10 ms] ofd 10 [OFF-delay timer: 10 ms]	When setting ON delay timer or OFF delay timer in the timer operation setting mode, timer delays can be set. • When timer is not set, this mode is not displayed.
Emission amount setting	PctL 1000 * [Level 3]	In case incident light intensity is saturated, emission amount can be reduced.
Emission frequency setting	FX-101 FrE9 F-0 [0 (Response time: 250 μs or less)] FX-102 FrE9 F-01 [1 (Response time: 2.5 ms or less)]	When using the fiber heads in parallel, interference can be prevented by setting different emission frequency. However, when emission frequency 0 is set, interference cannot be prevented. Response time corresponds to emission frequency.

* Indicated as "PctL off" before production in November 2007.

FIBER SENSORS

LASER SENSORS

PHOTO-ELECTRIC SENSORS

MICRO PHOTO-ELECTRIC SENSORS

AREA SENSORS

SAFETY LIGHT CURTAINS / SAFETY COMPONENTS

PRESSURE / FLOW SENSORS

INDUCTIVE PROXIMITY SENSORS

PARTICULAR USE SENSORS

SENSOR OPTIONS

SIMPLE WIRE-SAVING UNITS

WIRE-SAVING SYSTEMS

MEASUREMENT SENSORS

STATIC CONTROL DEVICES

LASER MARKERS

PLC

HUMAN MACHINE INTERFACES

ENERGY MANAGEMENT SOLUTIONS

FA COMPONENTS

MACHINE VISION SYSTEMS

UV CURING SYSTEMS

Selection Guide

Fibers

Fiber Amplifiers

Other Products

FX-500

FX-550







FX-100

FX-410

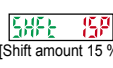
PRECAUTIONS FOR PROPER USE

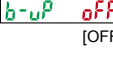
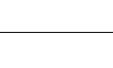
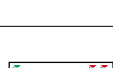
PRO mode

- PRO mode appears after the MODE key is pressed for 4 sec. in RUN mode.

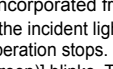
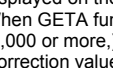
Setting item	Factory setting	Description
Shift setting		Shift amount can be selected from 0 to 80 % in the limit teaching. Select 0 % when it is desired to set the present incident light intensity as a threshold value.
External input setting		External input can be selected from emission halt, limit teaching [+], limit teaching [-], full-auto teaching, ECO (Note 1), 2-point teaching or emission amount test. When setting the incident light intensity test "E5E", output turns ON / OFF every 100ms when the rate of incident light intensity and threshold value is less than half of the set shift amount (for example, when the rate of incident light intensity and threshold value is within ±10 % for 20 % of shift amount) at external input.
Threshold value-storing setting mode (Note 2)		Threshold value set at the limit teaching, full-auto teaching or 2-point teaching by external input is stored. When selecting Auto in the emission amount setting mode, the set emission amount level is also stored.
Threshold value follow-up cycle setting (Note 3)		When incident light intensity exceeds threshold value, this mode can change the threshold value with each set cycle depending on variations of the incident light intensity. The follow-up shift amount is same as the one set in the shift setting mode. However, the threshold value is not stored.
GETA function setting (Note 4, 5)		Variations can be reduced by correcting the present incident light intensity in each amplifier to a target value. Target value to offset incident light intensity can be selected from 0 to 2,000 by 100 unit each. For example, if the target value is set to 2,000 when the incident light intensity is 1,500, the incident light intensity becomes 2,000.
ECO setting		It is possible to light up / turn off the digital display. When ECO setting mode is ON, the display turns off in 20 sec. approx. in RUN mode. To light up the display again, press any key for 2 sec. or more.
Digital display inversion setting		Digital display can be inverted.
Threshold value margin setting		Margin for threshold value to the present incident light intensity can be checked. When there is no margin, it is possible to make the digital display blink. off : Set to "OFF": does not function. on : Green blinks. red : Red blinks. Rlt : Red and green blink. in-t : When conducting limit teaching or 2-point teaching by external input, in case the rate of reference incident light intensity and threshold value after teaching is 200% or more, or in case it is less than half of the shift amount, output turns ON / OFF every 100 ms. (Note 6)
Setting copy		The settings of the master side amplifier can be copied to the slave side amplifier. For details, refer to "Setting copy function".
Reset		Returns to default settings (factory settings.)

- Notes: 1) When ECO is selected at the external input setting mode, key operation on the main body is invalid during external input.
- 2) This mode is not indicated unless any of "EtcP", "Etc-", "Auto" or "2-Pt" is set at the external input setting mode. (Incorporated from production in December 2007.)
- 3) If the incident light intensity becomes "300" or less, the follow-up operation stops. In that condition, threshold value [digital display (green)] blinks. This function can be used when thru-beam type or retroreflective type fiber is applied to this product. If reflective type fiber is applied, the function cannot be used depending on use conditions.
- 4) If MODE key is pressed in RUN mode when GETA function is used, the incident light intensity before setting GETA function is displayed on the red digital display for 2 sec. approx.
- 5) When GETA function is used in saturation of incident light intensity (4,000 or more,) "HR-d" is indicated on the red digital display. Correction value is up to 4,000.
- 6) This mode does not operate unless any of "EtcP", "Etc-" or "2-Pt" is set at the external input setting mode. (Incorporated from production in December 2007.)

Refer to p.1552 ~ for general precautions.
 Refer to General precautions, and to the "Operation Guide" on our website for details pertaining to operating instructions for the amplifier.

Setting copy function

- This can copy the settings of the master side amplifier to the slave side amplifier.

- Be sure to use the setting copy function between the identical models (Between **FX-101**□ models or **FX-102**□ models). This function cannot be used between different models.
- Only one sensor can be connected on slave side with a master side sensor for the setting copy function.
- Threshold value, output operation setting, timer operation setting, timer setting, light-emitting amount setting, shift setting, external input setting, threshold value margin setting, ECO setting, digital display inversion setting, and threshold value margin setting can be copied.

<Setting procedures>

- ① Set the setting copy mode of the master side amplifier to "Copy sending ON", and press the MODE key so that "COPY rEdY" is shown on the digital display and the sensor is in copy ready state. For the setting method, refer to "Operation guide".
- ② Turn off the master side amplifier.
- ③ Connect the master side amplifier with the slave side amplifier as shown below.

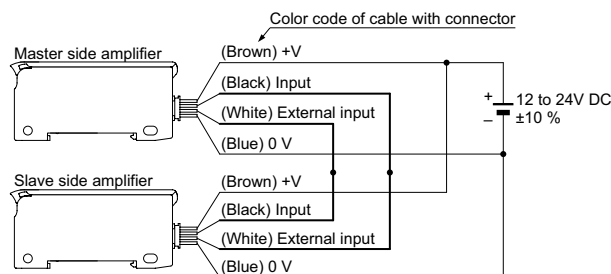

- ④ Turn on the master side amplifier and the slave side amplifier at the same time. (Note)
- ⑤ "COPY" is shown on the green digital display of the master side amplifier and 4-digit code is shown on the red digital display of the slave side amplifier, and the ongoing copy communication indicator ("I" → "II" → "III" → "IIII" → "IIIII") is displayed on the red digital display.
- ⑥ When the copying is completed, "Good" is shown on the green digital display of the slave side amplifier, while the 4-digit code (the same code as the master side amplifier) is shown on the red digital display of it.
- ⑦ Turn off the power of the master side amplifier and the slave side amplifier and disconnect the wire.

* If copying the settings to another amplifier repeatedly, follow the steps ③ to ⑦.

Note: Take care that if the power is not turned on at the same time, the setting contents may not be copied.

<To cancel the setting copy mode of the master side amplifier>

- ① While the slave side amplifier is disconnected, turn on the power of the master side amplifier.
- ② Press the MODE key for 2 sec. approx.

PRECAUTIONS FOR PROPER USE

Others

- This product has been developed / produced for industrial use only.
- Do not use during the initial transient time (0.5 sec.) after the power supply is switched on.
- Take care that the product is not directly exposed to fluorescent lamp from a rapid-starter lamp, a high frequency lighting device or sunlight etc., as it may affect the sensing performance.
- This product is suitable for indoor use only.
- Avoid dust, dirt, and steam.
- Take care that the product does not come in contact with oil, grease, organic solvents, such as thinner, etc., strong acid or alkaline.
- This product cannot be used in an environment containing inflammable or explosive gases.
- Never disassemble or modify this product.
- EEPROM is adopted to this product. It is not possible to conduct teaching 100 thousand times or more, because of the EEPROM's lifetime.

Quick setting function

- The quick setting function makes it possible to set the content of the SET Mode (output operation, timer operation, amount of light emitted, and frequency of light emitted) simply by selecting a setting number.
- While in the RUN Mode, pressing and holding both the ON key (⏻) and OFF key (⏹) simultaneously for 2 seconds will switch to the quick setting function.

<Table of quick setting numbers>

No.	Output operation	Timer	Emission amount setting (Note)
-00-	D-ON	non	Level 3 (OFF)
-01-	D-ON	non	Level 2 (ON)
-02-	D-ON	ofd 10 ms	Level 3 (OFF)
-03-	D-ON	ofd 10 ms	Level 2 (ON)
-04-	D-ON	ofd 40 ms	Level 3 (OFF)
-05-	D-ON	ofd 40 ms	Level 2 (ON)
-06-	D-ON	ond 10 ms	Level 3 (OFF)
-07-	D-ON	ond 10 ms	Level 2 (ON)
-08-	D-ON	ond 40 ms	Level 3 (OFF)
-09-	D-ON	ond 40 ms	Level 2 (ON)
-10-	L-ON	ond 40 ms	Level 2 (ON)
-11-	L-ON	ond 40 ms	Level 3 (OFF)
-12-	L-ON	ond 10 ms	Level 2 (ON)
-13-	L-ON	ond 10 ms	Level 3 (OFF)
-14-	L-ON	ofd 40 ms	Level 2 (ON)
-15-	L-ON	ofd 40 ms	Level 3 (OFF)
-16-	L-ON	ofd 10 ms	Level 2 (ON)
-17-	L-ON	ofd 10 ms	Level 3 (OFF)
-18-	L-ON	non	Level 2 (ON)
-19-	L-ON	non	Level 3 (OFF)

Note: Until production in November 2007, OFF or ON was selectable. The emission amount of Level 2 (ON) is about 40% of that of Level 3 (OFF).

Difference between previous model and upgraded one

- For upgraded ones (production in and after December 2007), "P" is marked near the beam-emitting inlet. Previous ones have no marking. Appearance and functions have been changed.

<After upgrade>

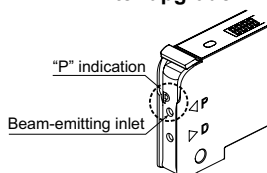

<Previous>

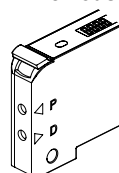

Refer to p.1552 ~ for general precautions.

Refer to General precautions, and to the "Operation Guide" on our website for details pertaining to operating instructions for the amplifier.

Code setting function

- The code setting function makes it possible to set the output operation, timer operation, amount of light emitted, frequency of light emitted, ECO setting, external input, and amount of shift by selecting a code of one's choice.
- While in the RUN Mode, pressing and holding both the ON key (⏻) and OFF key (⏹) simultaneously for 4 seconds will switch to the code setting function.

<Code table>



Code	1st digit		2nd digit		ECO	3rd digit	4th digit		
	Output operation	Timer (Note 1)	Emission amount setting (Note 2)	Emission frequency					
				FX-101□				FX-102□	
0	D-ON	non	Level 3 (OFF)	0	1	OFF	Emission halt	5 %	
1		ond 10 ms		1	2		Limit teaching [+]	10 %	
2		ofd 40 ms		2	3		Limit teaching [-]	15 %	
3		ofd 10 ms		3	4		Full-auto teaching	20 %	
4	L-ON	ofd 40 ms	Level 2 (ON)	0	1	ON	ECO	25 %	
5		non		1	2		Emission halt	30 %	
6		ond 10 ms		2	3		Limit teaching [+]	35 %	
7		ond 40 ms		3	4		Limit teaching [-]	40 %	
8	L-ON	ofd 10 ms	Level 1	0	1	OFF	Full-auto teaching	45 %	
9		ofd 40 ms		1	2		ECO	50 %	
A		Auto		non	2		3	2-point teaching	Incident light intensity test
B					3		4		
C	L-ON	non	Level 2 (ON)	0	1	ON	2-point teaching	Incident light intensity test	
D		ond 40 ms		1	2				
E		ond 10 ms		2	3				
F		ofd 10 ms		3	4				

- Notes: 1) When the present setting is out of the code setting range, "-" is shown. When "-" is selected, the set content of the digit is not changed.
 2) Until production in November 2007, OFF or ON was selectable. The emission amount of Level 2 is about 40% of that of Level 3. The emission amount of Level 1 is about 20% of that of Level 3.
 3) The factory setting is "0002".

FIBER SENSORS

LASER SENSORS

PHOTO-ELECTRIC SENSORS

MICRO PHOTO-ELECTRIC SENSORS

AREA SENSORS

SAFETY LIGHT CURTAINS / SAFETY COMPONENTS

PRESSURE / FLOW SENSORS

INDUCTIVE PROXIMITY SENSORS

PARTICULAR USE SENSORS

SENSOR OPTIONS

WIRE-SAVING UNITS

WIRE-SAVING SYSTEMS

MEASUREMENT SENSORS

STATIC CONTROL DEVICES

LASER MARKERS

PLC

HUMAN MACHINE INTERFACES

ENERGY MANAGEMENT SOLUTIONS

FA COMPONENTS

MACHINE VISION SYSTEMS

UV CURING SYSTEMS

Selection Guide

Fibers

Fiber Amplifiers

Other Products

FX-500

FX-550

FX-100

FX-410

Refer to p.63~ for dimensions of the fibers.
The CAD data can be downloaded from our website.

DIMENSIONS (Unit: mm in)

FX-101□ FX-102□ Amplifier

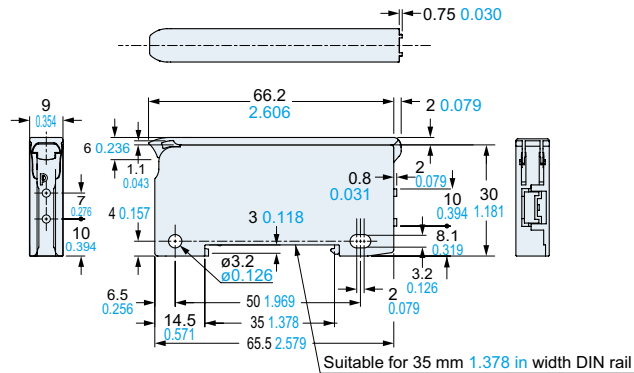
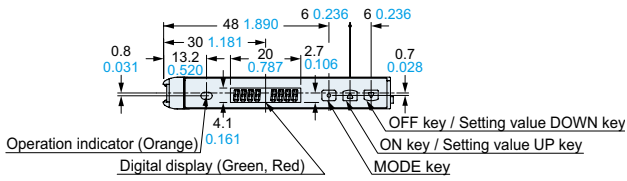

Note: The protection cover has been attached from the production at July, 2011.

FX-101(P)-Z FX-102(P)-Z Amplifier

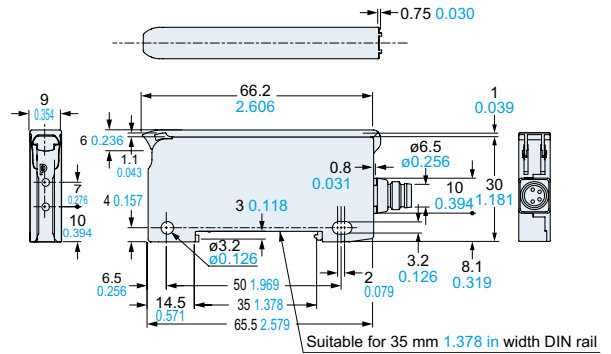
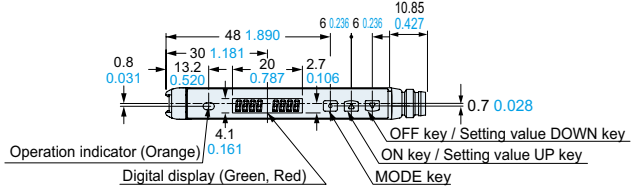

Note: The protection cover has been attached from the production at July, 2011.

MS-DIN-4 Amplifier mounting bracket (Optional)

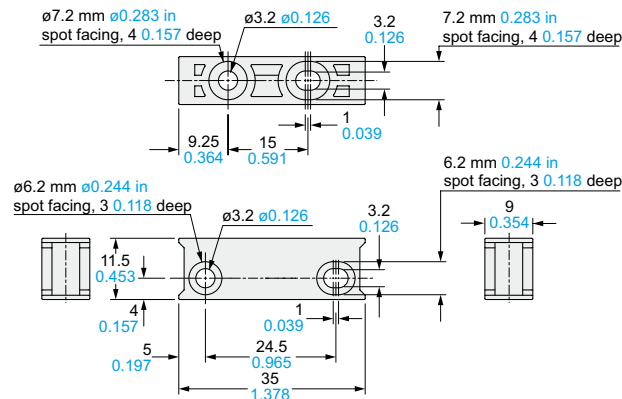

Material: PBT

MS-DIN-E End plate (Optional)

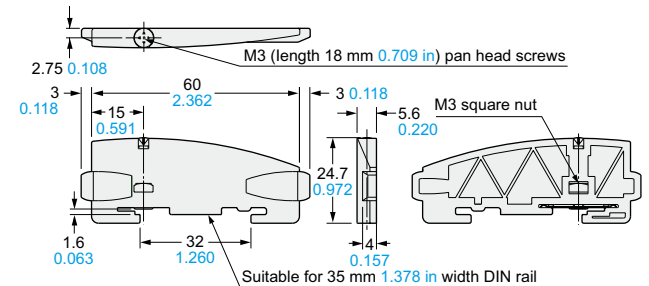

Material: Polycarbonate

CN-14A-C□ CN-14A-R-C□ Connector attached cable (Optional)

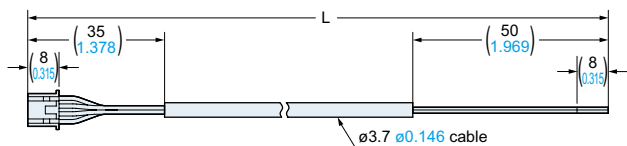

CN-14A-C2 is attached to FX-101(P)-CC2 / FX-102(P)-CC2

• Length L

Model No.	Length L
CN-14A(-R)-C1	1,000 39.370
CN-14A(-R)-C2	2,000 78.740
CN-14A(-R)-C3	3,000 118.110
CN-14A(-R)-C5	5,000 196.850