

# Digital Fiber Sensor FX-550 SERIES

- FIBER SENSORS
- LASER SENSORS
- PHOTOELECTRIC SENSORS
- MICRO PHOTOELECTRIC SENSORS
- AREA SENSORS
- SAFETY LIGHT CURTAINS / SAFETY COMPONENTS
- PRESSURE / FLOW SENSORS
- INDUCTIVE PROXIMITY SENSORS
- PARTICULAR USE SENSORS
- SENSOR OPTIONS
- SIMPLE WIRE- SAVING UNITS
- WIRE- SAVING SYSTEMS
- MEASUREMENT SENSORS
- STATIC CONTROL DEVICES
- LASER MARKERS
- PLC

- General terms and conditions..... F-3
- Selection guide ..... P.3~
- Fiber selection..... P.5~
- Glossary of terms..... P.1549~
- General precautions ..... P.1552~



- PNP output type available
- Timer
- Interference prevention
- Light intensity monitor
- Automatic sensitivity setting

**Significantly improved stability and operation ease thanks to the industry's top\* emission power and enhanced versatility!**

\* As of January 2016, in-company survey

**Industry's No. 1!\*** Three times higher emission power and 1.6 times longer sensing range than conventional models!

\* As of January 2016, in-company survey

### Ample sensing distance even with thin fiber

The sensing range of the thin reflective type fiber is about 1.6 times longer than that of a conventional product (the sensing range of the standard reflective type fiber is about 1.4 times longer). This adds extra flexibility to the sensor layout.

Fiber	Sensing range (STD mode)		Rate of increase in sensing range
	FX-551	FX-501	
FT-31	480 mm 18.898 in	315 mm 12.402 in	152 %
FT-42	1,470 mm 57.874 in	1,130 mm 44.488 in	130 %
FD-41	200 mm 7.874 in	125 mm 4.921 in	160 %
FD-61	620 mm 24.409 in	450 mm 17.717 in	138 %



**1.6 times approx.**  
longer than conventional models!

**When the hysteresis is the same, the higher incident light intensity results in more stable detection.**

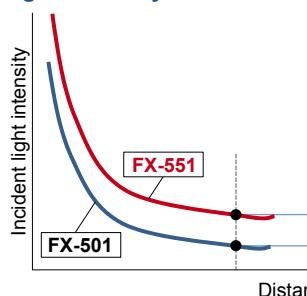

When the hysteresis is the same, the higher incident light intensity results in more stable detection.

**Stable detection!**

**Easy adjustment of beam axis**

Thanks to the high emission power, a slight deviation of beam axis causes no problem. It is ideal for use in dusty areas\* or for detection through an extremely small slit.

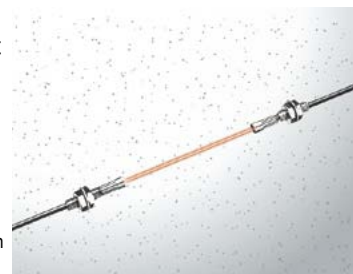

\* Need to confirm proper operation in installed condition.

**Equipped with a mode to minimize the effect of ambient light**

When setting to activate the environment resistance mode in the emission frequency setting, the ambient illuminance for LED lights becomes about 2.5 times higher than that in the normal mode. This reduces erroneous detections caused by LED lights.



- Selection Guide
- Fibers
- Fiber Amplifiers
- Other Products

- FX-500
- FX-550**
- FX-100
- FX-410

## Simplified functions for improved operation ease

The **FX-500** series and newer models are equipped with only basic functions for improved ease of use. No matter which model you select, they are all easy to use.

### MODE NAVI + Direct setting

MODE NAVI uses three indicators and a dual display to show the amplifier's basic operations. The current operation mode can be confirmed at a glance, so even a first-time user can easily operate the amplifier.

#### NAVI display (lights off during RUN mode)

**L/D**  
Switches output operation.  
L: Light-ON D: Dark-ON

**CUST**  
The sensitivity to received light can be changed directly.

**PRO**  
Allows the selection of advanced functions such as timer, shift amount setting and threshold value tracking setting.

#### Direct setting

Threshold value can be changed during RUN mode.

Teaching can be done during RUN mode.

#### List of functions in PRO mode

PRO 1	Response time setting, timer setting, shift amount setting
PRO 2	Teaching lock setting, digital display item setting, digital display turning setting, Eco setting
PRO 3	Display adjustment setting, reset setting, emission frequency setting, threshold value tracking setting

### No need to specify a main unit or sub unit

All **FX-500** amplifiers can be used as either a main unit or a sub unit. Just use a main cable or a sub cable to distinguish the two. This reduces the costs of inventory management.

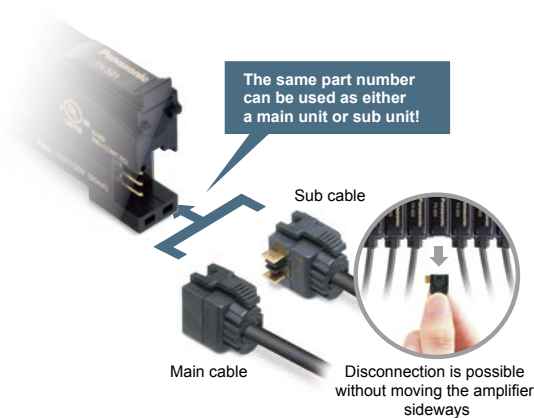

### Wire-saving, space-saving

The quick-connection cables enable reduction in wiring. The connections and man-hours required for the relay terminal block setup can be reduced and valuable space is saved.

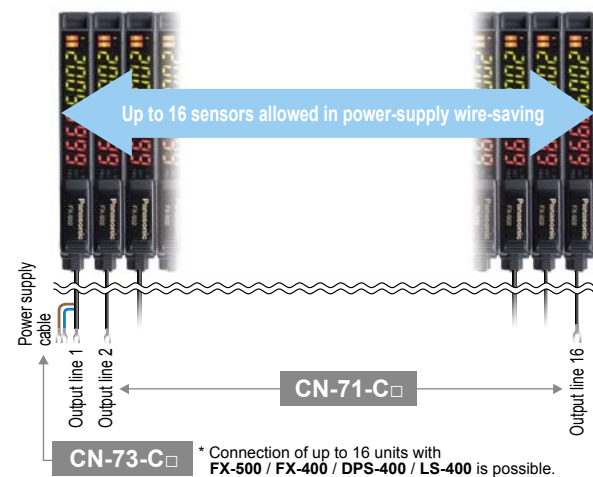

Note: **FX-550** series is not equipped with a communication function. When connecting to the host communication units **SC-GU3** series and **SC-GU1-485**, please use **FX-500** series.

#### FIBER SENSORS

#### LASER SENSORS

#### PHOTOELECTRIC SENSORS

#### MICRO PHOTOELECTRIC SENSORS

#### AREA SENSORS

#### SAFETY LIGHT CURTAINS / SAFETY COMPONENTS

#### PRESSURE / FLOW SENSORS

#### INDUCTIVE PROXIMITY SENSORS

#### PARTICULAR USE SENSORS

#### SENSOR OPTIONS

#### SIMPLE WIRE-SAVING UNITS

#### WIRE-SAVING SYSTEMS

#### MEASUREMENT SENSORS

#### STATIC CONTROL DEVICES

#### LASER MARKERS

#### PLC

#### HUMAN MACHINE INTERFACES

#### ENERGY MANAGEMENT SOLUTIONS

#### FA COMPONENTS

#### MACHINE VISION SYSTEMS

#### UV CURING SYSTEMS

#### Selection Guide

#### Fibers

#### Fiber Amplifiers

#### Other Products

#### FX-500

#### FX-550



#### FX-100

#### FX-410

FIBER SENSORS  
LASER SENSORS  
PHOTO-ELECTRIC SENSORS  
MICRO PHOTO-ELECTRIC SENSORS  
AREA SENSORS  
SAFETY LIGHT CURTAINS / SAFETY COMPONENTS  
PRESSURE / FLOW SENSORS  
INDUCTIVE PROXIMITY SENSORS  
PARTICULAR USE SENSORS  
SENSOR OPTIONS  
SIMPLE WIRE-SAVING UNITS  
WIRE-SAVING SYSTEMS  
MEASUREMENT SENSORS  
STATIC CONTROL DEVICES  
LASER MARKERS  
PLC  
HUMAN MACHINE INTERFACES  
ENERGY MANAGEMENT SOLUTIONS  
FA COMPONENTS  
MACHINE VISION SYSTEMS  
UV CURING SYSTEMS

## ORDER GUIDE

**Amplifiers** Quick-connection cable is not supplied with **FX-551(P)**. Please order it separately.

Type	Appearance	Model No.	Emitting element	Output
Connector type		<b>FX-551</b>	Red LED	NPN open-collector transistor
		<b>FX-551P</b>		PNP open-collector transistor
Cable type		<b>FX-551-C2</b>		NPN open-collector transistor
		<b>FX-551P-C2</b>		PNP open-collector transistor

**Quick-connection cables** Quick-connection cable is not supplied with the connector type amplifier. Please order it separately.

Type	Model No.	Description	
Main cable (3-core)	<b>CN-73-C1</b>	Length: 1 m <b>3.281 ft</b>	0.2 mm <sup>2</sup> 3-core cabtyre cable, with connector on one end Cable outer diameter: $\varnothing$ 3.3 mm $\varnothing$ 0.130 in
	<b>CN-73-C2</b>	Length: 2 m <b>6.562 ft</b>	
	<b>CN-73-C5</b>	Length: 5 m <b>16.404 ft</b>	
Sub cable (1-core)	<b>CN-71-C1</b>	Length: 1 m <b>3.281 ft</b>	0.2 mm <sup>2</sup> 1-core cabtyre cable, with connector on one end Cable outer diameter: $\varnothing$ 3.3 mm $\varnothing$ 0.130 in Connectable to a main cable up to 15 cables.
	<b>CN-71-C2</b>	Length: 2 m <b>6.562 ft</b>	
	<b>CN-71-C5</b>	Length: 5 m <b>16.404 ft</b>	

**Main cable**

- **CN-73-C□**

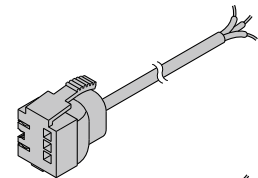

**Sub cable**

- **CN-71-C□**

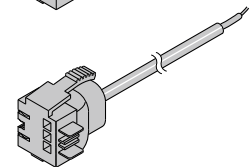

**End plates** End plates are not supplied with the amplifier. Please order them separately when the amplifiers are mounted in cascade.

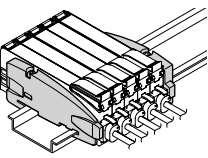
Appearance	Model No.	Description
	<b>MS-DIN-E</b>	When amplifiers are mounted in cascade, or when an amplifier moves depending on the way it is installed on a DIN rail, these end plates clamp amplifiers into place on both sides. Make sure to use end plates when cascading multiple amplifiers together. <b>2 pcs. per set</b>

## OPTIONS

Designation	Model No.	Description
Amplifier mounting bracket	<b>MS-DIN-2</b>	Mounting bracket for amplifier

**Amplifier mounting bracket**

- **MS-DIN-2**

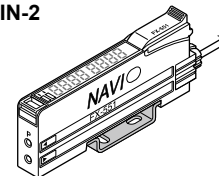

## LIST OF FIBERS

Refer to "Fiber Selection p.5 ~" for details of each fiber.

Selection Guide  
Fibers  
Fiber Amplifiers  
Other Products  
**FX-500**  
**FX-550**  
**FX-100**  
**FX-410**

## SPECIFICATIONS

Item	Model No.	Type	Connector type	Cable type
		NPN output	<b>FX-551</b>	<b>FX-551-C2</b>
		PNP output	<b>FX-551P</b>	<b>FX-551P-C2</b>
CE marking directive compliance		EMC Directive, RoHS Directive		
Supply voltage		12 to 24 V DC $\pm 10\%$ Ripple P-P 10 % or less		
Power consumption		Normal operation: 960 mW or less (current consumption 40 mA or less at 24 V supply voltage) ECO mode: 680 mW or less (current consumption 28 mA or less at 24 V supply voltage)		
Output		<NPN output type> NPN open-collector transistor • Maximum sink current: 100 mA • Applied voltage: 30 V DC or less (between output and 0 V) • Residual voltage: 2 V or less (Note 2) (at maximum sink current)	<PNP output type> PNP open-collector transistor • Maximum source current: 100 mA • Applied voltage: 30 V DC or less (between output and +V) • Residual voltage: 2 V or less (Note 2) (at maximum source current)	
	Output operation	Switchable either Light-ON or Dark-ON by L/D mode		
	Short-circuit protection	Incorporated		
Response time		FAST: 60 $\mu$ s or less, STD: 250 $\mu$ s or less, LONG: 2 ms or less, U-LG: 4 ms or less, HYPR: 24 ms or less, selectable		
Sensitivity setting		2-point teaching / Limit teaching / Full-auto teaching / Manual adjustment		
Incident light sensitivity setting		Incorporated, 4 steps		
Incident light intensity display range		FAST / STD: 0 to 4,000, LONG: 0 to 8,000, U-LG / HYPR: 0 to 9,999		
Timer function		Incorporated with variable OFF-delay / ON-delay / One-shot / switchable either effective or ineffective		
	Timer period	Timer range "ms": 1 to 9,999 ms approx., 1 ms approx., Timer range "sec.": 1 to 32 s approx., 1 s approx., Timer range "1/10 ms": 0.1 to 999.9 ms approx., 0.1 ms approx. (Note 3)		
Different frequency interference prevention function (Note 4)		Incorporated (up to 4 units). Note that the response time varies depending on the setting. F-1: 0.8 ms or less, F-2: 0.9 ms or less, F-3: 1.0 ms or less, F-4: 1.7 ms or less		
Protection		IP40 (IEC)		
Ambient temperature		-10 to +55 °C <b>+14 to +131 °F</b> (If 4 to 7 units are mounted in cascade: -10 to +50 °C <b>+14 to +122 °F</b> or if 8 to 16 units are mounted in cascade: -10 to +45 °C <b>+14 to +113 °F</b> ) (No dew condensation or icing allowed), Storage: -20 to +70 °C <b>-4 to +158 °F</b>		
Emitting element (modulated)		Red LED (Peak emission wavelength: 660 nm <b>0.026 mil</b> )		
Material		Enclosure, Case cover: Polycarbonate, Switch: Polyacetal		
Cable		0.2 mm <sup>2</sup> 3-core cabtyre cable, 2 m <b>6.562 ft</b> long		
Cable extension		Extension up to total 100 m <b>328.084 ft</b> is possible with 0.3 mm <sup>2</sup> , or more, cable. (however, supply voltage 12 V DC or more)		
Weight		Net weight: 15 g approx., Gross weight: 55 g approx. Net weight: 55 g approx., Gross weight: 90 g approx.		

Notes: 1) Where measurement conditions have not been specified precisely, the conditions used were an ambient temperature of +23 °C **+73.4 °F**.

2) In case of using the quick-connection cable (cable length 5 m **16.404 ft**) (optional).

3) When set to LONG, U-LG, HYPR, IP-F or IP-R, the time range cannot be set to 1/10 ms.

4) This function increases the hysteresis. Check the sensing condition when using the function.

FIBER SENSORS

LASER SENSORS

PHOTO-ELECTRIC SENSORS

MICRO PHOTO-ELECTRIC SENSORS

AREA SENSORS

SAFETY LIGHT CURTAINS / SAFETY COMPONENTS

PRESSURE / FLOW SENSORS

INDUCTIVE PROXIMITY SENSORS

PARTICULAR USE SENSORS

SENSOR OPTIONS

SIMPLE WIRE-SAVING UNITS

WIRE-SAVING SYSTEMS

MEASUREMENT SENSORS

STATIC CONTROL DEVICES

LASER MARKERS

PLC

HUMAN MACHINE INTERFACES

ENERGY MANAGEMENT SOLUTIONS

FA COMPONENTS

MACHINE VISION SYSTEMS

UV CURING SYSTEMS

Selection Guide

Fibers

Fiber Amplifiers

Other Products

FX-500

FX-550

FX-100

FX-410

## I/O CIRCUIT AND WIRING DIAGRAMS

### FX-551(-C2)

NPN output type

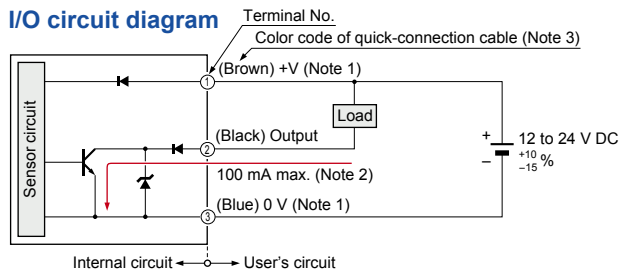

Notes: 1) The quick-connection sub cable does not have +V (brown) and 0 V (blue). The power is supplied from the connector of the main cable.  
2) 50 mA max., if five amplifiers or more, are connected together.  
3) The color code of the connector attached cable is also the same.

### Wiring diagram

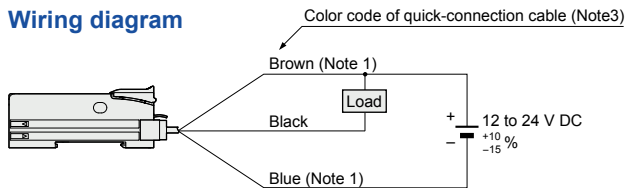

Note: The quick-connection sub cable does not have a brown and a blue lead wire.

### Terminal arrangement diagram

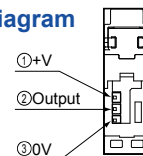

### FX-551P(-C2)

PNP output type

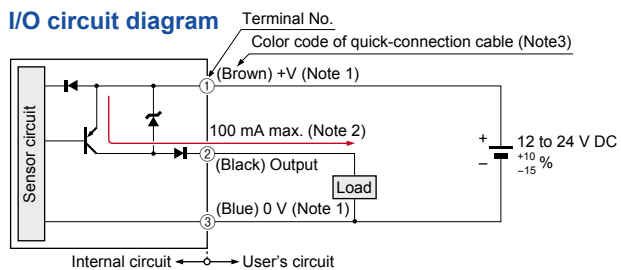

Notes: 1) The quick-connection sub cable does not have +V (brown) and 0 V (blue). The power is supplied from the connector of the main cable.  
2) 50 mA max., if five amplifiers or more, are connected together.  
3) The color code of the connector attached cable is also the same.

### Wiring diagram

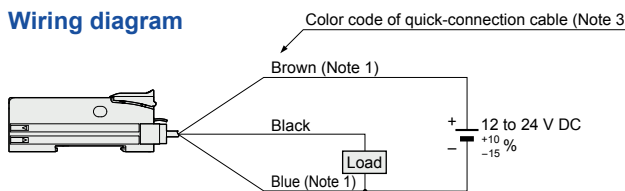

Note: The quick-connection sub cable does not have a brown and a blue lead wire.

### Terminal arrangement diagram

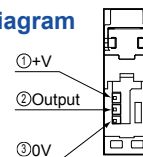

## PRECAUTIONS FOR PROPER USE

Refer to p.1552~ for general precautions.



- Never use this product as a sensing device for personnel protection.
- In case of using sensing devices for personnel protection, use products which meet laws and standards, such as OSHA, ANSI or IEC etc., for personnel protection applicable in each region or country.

### Wiring

- Make sure that the power supply is OFF while adding or removing the amplifiers.
- Note that if a voltage exceeding the rated range is applied, or if an AC power supply is directly connected, the product may get burnt or damaged.
- Note that short-circuit of the load or wrong wiring may burn or damage the product.
- Do not run the wires together with high-voltage lines or power lines, or put them in the same raceway. This can cause malfunction due to induction.
- Verify that the supply voltage variation is within the rating.
- If power is supplied from a commercial switching regulator, ensure that the frame ground (F.G.) terminal of the power supply is connected to an actual ground.
- In case noise generating equipment (switching regulator, inverter motor, etc.) is used in the vicinity of this product, connect the frame ground (F.G.) terminal of the equipment to an actual ground.

### Others

- This product has been developed / produced for industrial use only.
- The specification may not be satisfied in a strong magnetic field.
- The ultra long distance (U-LG, HYPR) mode is more likely to be affected by extraneous noise since the sensitivity of that is higher than the other modes. Make sure to check the environment before use.
- Do not use during the initial transient time (FAST, STD: 0.5 sec., U-LG, HYPR: 1 sec.) after the power supply is switched ON.
- These sensors are only for indoor use.
- Avoid dust, dirt, and steam.
- Make sure that the product does not come in contact with oil, grease, organic solvents such as thinner, etc., strong acid or alkaline.
- This product cannot be used in an environment containing inflammable or explosive gases.
- Never disassemble or modify this product.
- This product adopts EEPROM. Settings cannot be done a million times or more because of the EEPROM's lifetime.

**SENSING CHARACTERISTICS (TYPICAL)**

Contact our office for sensing characteristics that are not contained here.

FIBER SENSORS

**FT-31** Thru-beam type

Parallel deviation

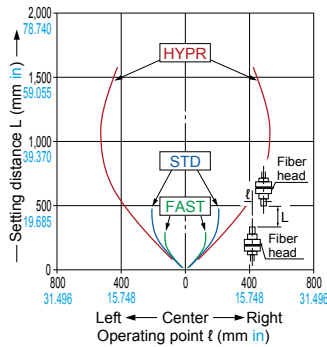

**FT-32** Thru-beam type

Parallel deviation

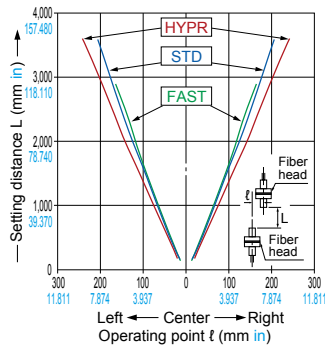

**FT-42** Thru-beam type

Parallel deviation

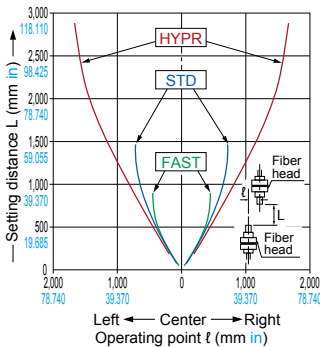

**FT-A11** Thru-beam type

Parallel deviation

• Horizontal direction

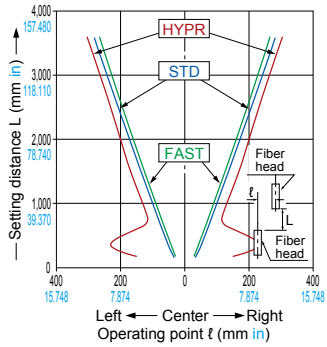

• Vertical direction

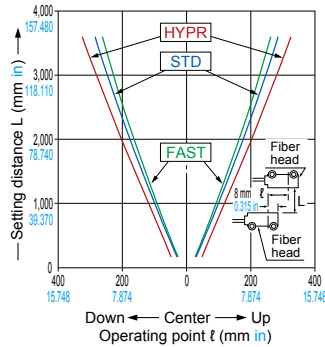

**FT-R31** Thru-beam type

Parallel deviation

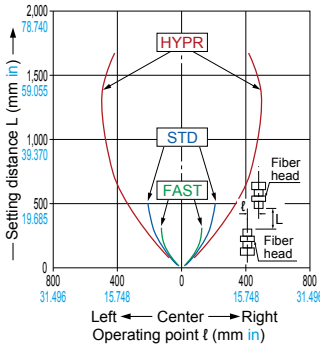

**FT-R43** Thru-beam type

Parallel deviation

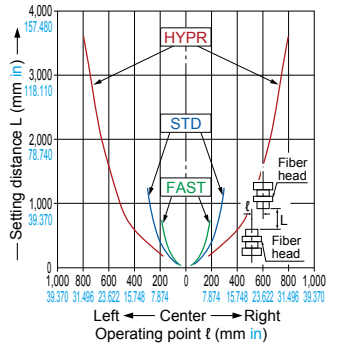

**FT-R60Y** Thru-beam type

Parallel deviation

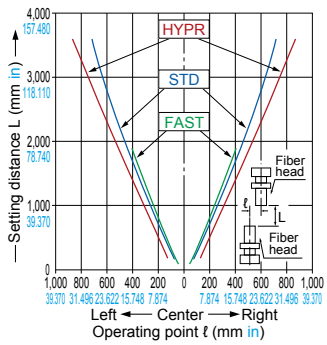

**FT-S21** Thru-beam type

Parallel deviation

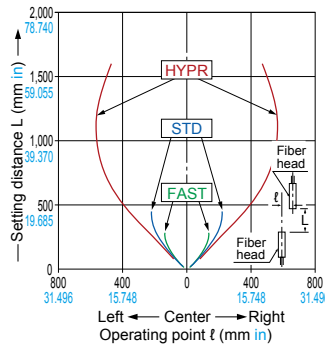

**FT-S22** Thru-beam type

Parallel deviation

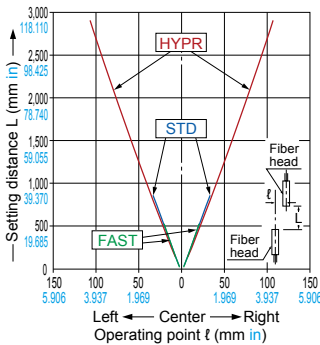

**FT-V25** Thru-beam type

Parallel deviation

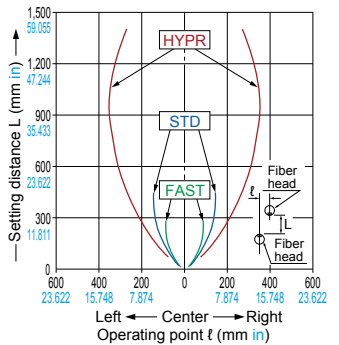

**FD-31 FD-41** Reflective type

Sensing field

• Horizontal direction

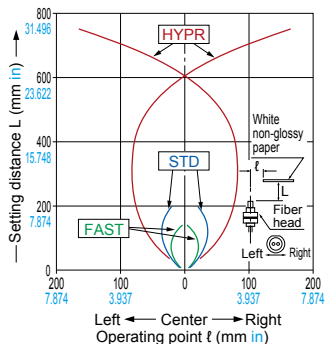

• Vertical direction

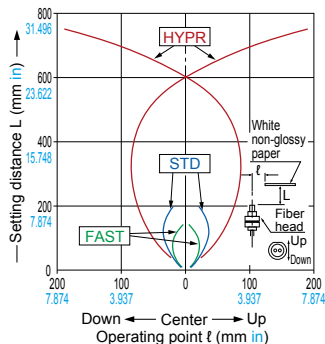

**FD-32G FD-42G** Reflective type

Sensing field

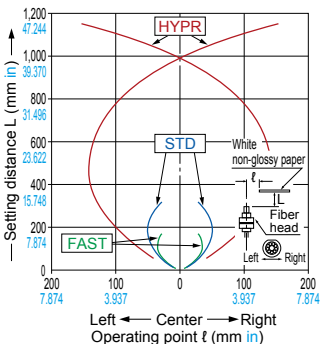

**FD-34G FD-S34G** Reflective type

Sensing field

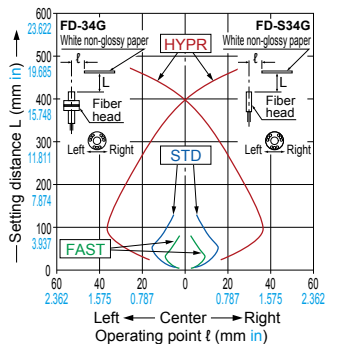

LASER SENSORS

PHOTO-ELECTRIC SENSORS

MICRO PHOTO-ELECTRIC SENSORS

AREA SENSORS

SAFETY LIGHT CURTAINS / SAFETY COMPONENTS

PRESSURE / FLOW SENSORS

INDUCTIVE PROXIMITY SENSORS

PARTICULAR USE SENSORS

SENSOR OPTIONS

SIMPLE WIRE-SAVING UNITS

WIRE-SAVING SYSTEMS

MEASUREMENT SENSORS

STATIC CONTROL DEVICES

LASER MARKERS

PLC

HUMAN MACHINE INTERFACES

ENERGY MANAGEMENT SOLUTIONS

FA COMPONENTS

MACHINE VISION SYSTEMS

UV CURING SYSTEMS

Selection Guide

Fibers

Fiber Amplifiers

Other Products

FX-500

FX-550

FX-100

FX-410

**SENSING CHARACTERISTICS (TYPICAL)**

Contact our office for sensing characteristics that are not contained here.

- FIBER SENSORS
- LASER SENSORS
- PHOTO-ELECTRIC SENSORS
- MICRO PHOTO-ELECTRIC SENSORS
- AREA SENSORS
- SAFETY LIGHT CURTAINS / SAFETY COMPONENTS
- PRESSURE / FLOW SENSORS
- INDUCTIVE PROXIMITY SENSORS
- PARTICULAR USE SENSORS
- SENSOR OPTIONS
- SIMPLE WIRE-SAVING UNITS
- WIRE-SAVING SYSTEMS
- MEASUREMENT SENSORS
- STATIC CONTROL DEVICES
- LASER MARKERS
- PLC
- HUMAN MACHINE INTERFACES
- ENERGY MANAGEMENT SOLUTIONS
- FA COMPONENTS
- MACHINE VISION SYSTEMS
- UV CURING SYSTEMS
- Selection Guide
- Fibers
- Fiber Amplifiers
- Other Products
- FX-500**
- FX-550**
- FX-100**
- FX-410**

**FD-61** Reflective type

Sensing field  
• Horizontal direction

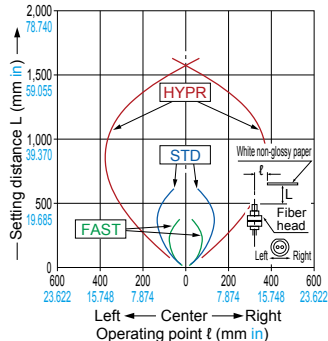

• Vertical direction

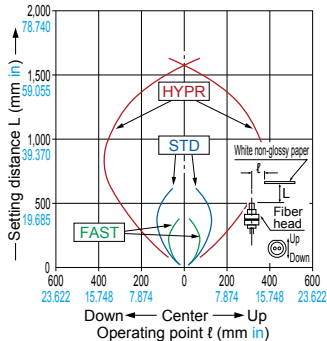

**FD-61G** Reflective type

Sensing field

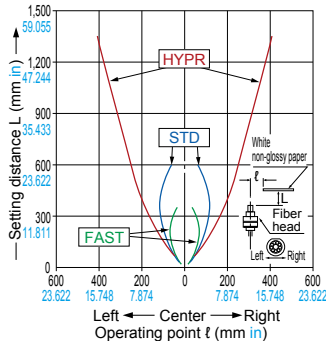

**FD-AL11** Reflective type

Sensing field  
• Horizontal direction

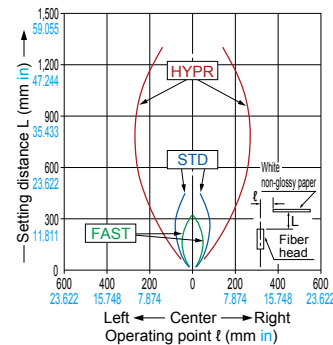

• Vertical direction

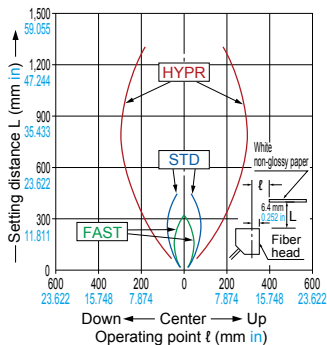

**FD-E23** Reflective type

Sensing field

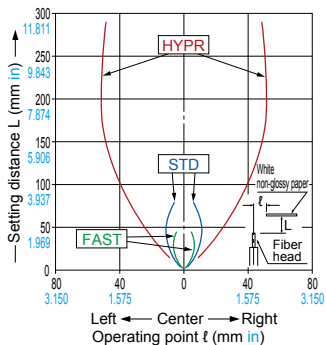

**FD-R31G** Reflective type

Sensing field

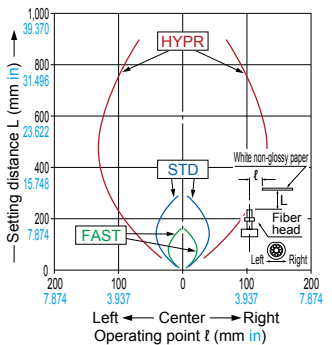

**FD-R41** Reflective type

Sensing field  
• Horizontal direction

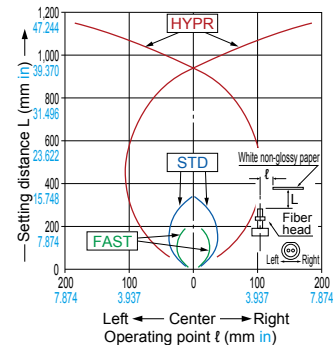

• Vertical direction

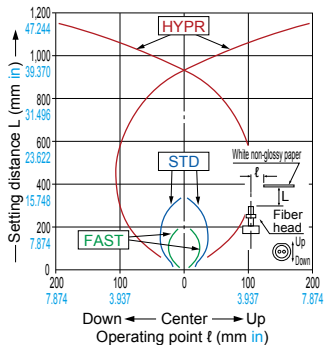

**FD-S21** Reflective type

Sensing field  
• Horizontal direction

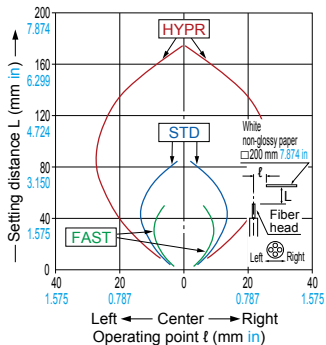

• Vertical direction

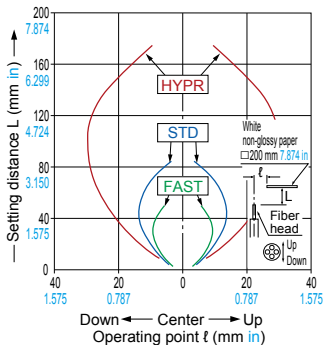

**FD-S31** Reflective type

Sensing field  
• Horizontal direction

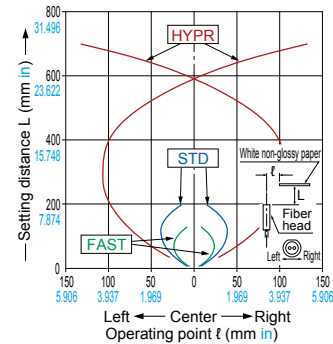

• Vertical direction

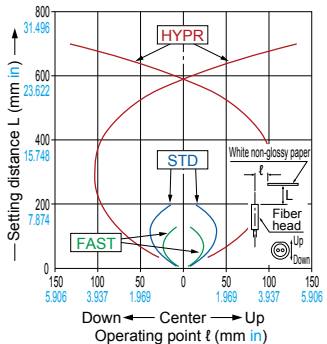

**FD-S32** Reflective type

Sensing field  
• Horizontal direction

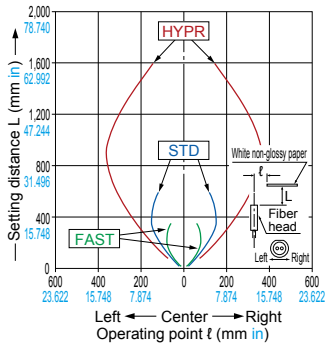

• Vertical direction

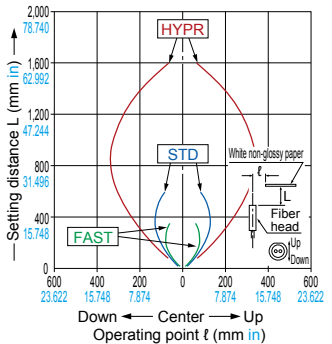

**SENSING CHARACTERISTICS (TYPICAL)**

Contact our office for sensing characteristics that are not contained here.

**FD-V30**

Reflective type

Sensing field  
• Horizontal direction

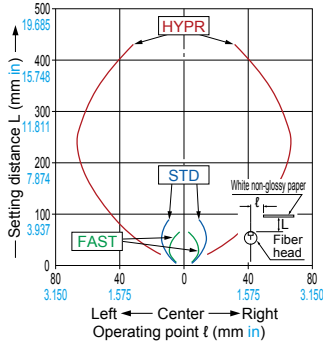

• Vertical direction

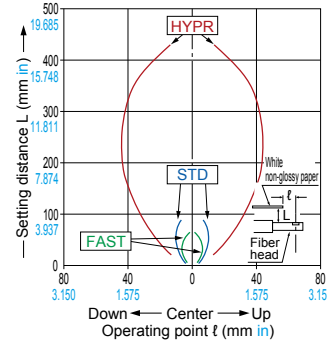

**FD-Z50HW**

Reflective type

Sensing field  
• Horizontal direction

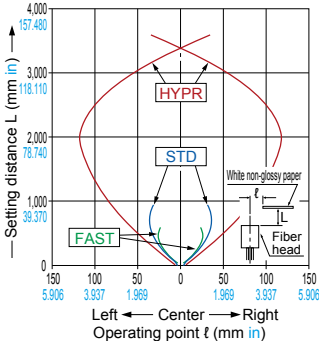

• Vertical direction

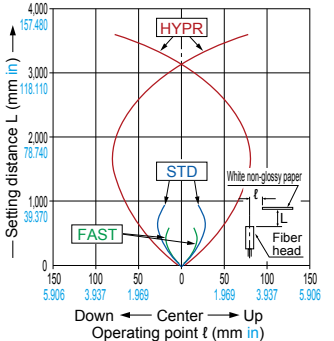

**DIMENSIONS (Unit: mm in)**

Refer to p.63~ for dimensions of the fibers.  
The CAD data can be downloaded from our website.

**FX-551(P)**

Amplifier

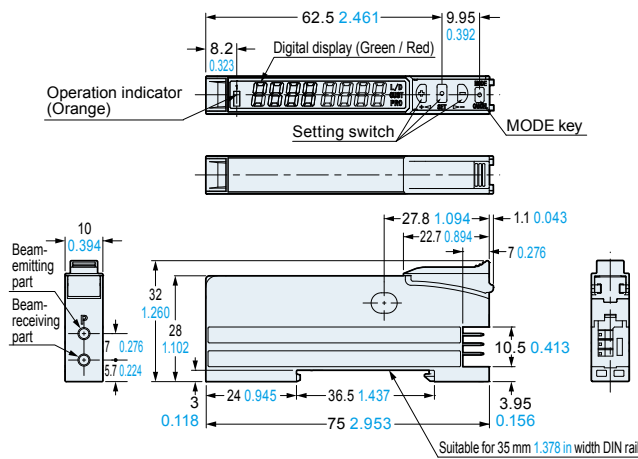

**FX-551(P)-C2**

Amplifier

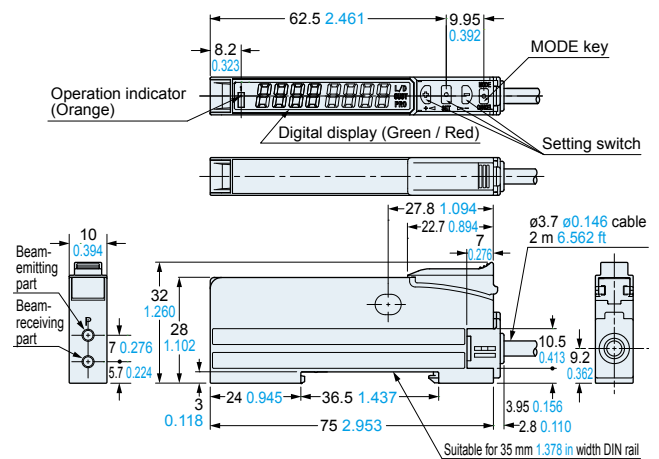

**CN-73-C□**

Main cable (Optional)

• Length L

Model No.	Length L
<b>CN-73-C1</b>	1,000 39.370
<b>CN-73-C2</b>	2,000 78.740
<b>CN-73-C5</b>	5,000 196.850

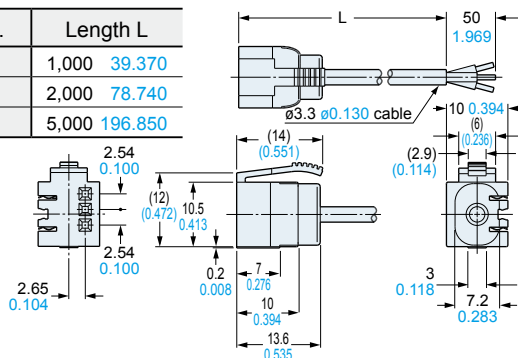

**CN-71-C□**

Sub cable (Optional)

• Length L

Model No.	Length L
<b>CN-71-C1</b>	1,000 39.370
<b>CN-71-C2</b>	2,000 78.740
<b>CN-71-C5</b>	5,000 196.850

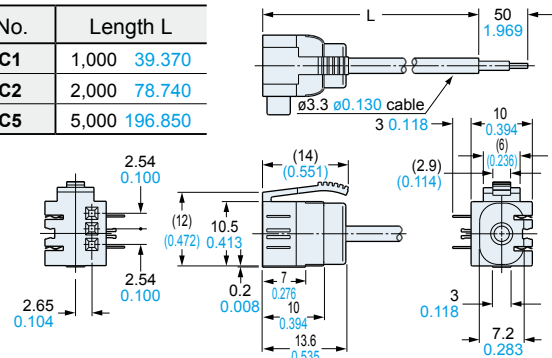

**MS-DIN-2**

Amplifier mounting bracket (Optional)

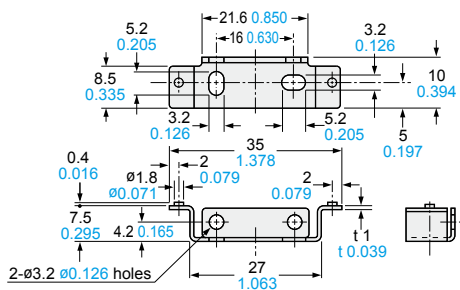

Material: Cold rolled carbon steel (SPCC) (Uni-chrome plated)

**MS-DIN-E**

End plate (Optional)

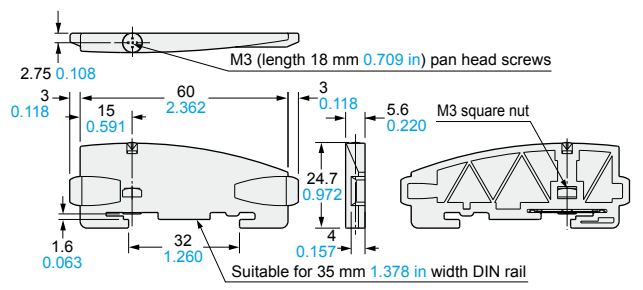

Material: Polycarbonate

FIBER SENSORS

LASER SENSORS

PHOTO-ELECTRIC SENSORS

MICRO PHOTO-ELECTRIC SENSORS

AREA SENSORS

SAFETY LIGHT CURTAINS / SAFETY COMPONENTS

PRESSURE / FLOW SENSORS

INDUCTIVE PROXIMITY SENSORS

PARTICULAR USE SENSORS

SENSOR OPTIONS

SIMPLE WIRE-SAVING UNITS

WIRE-SAVING SYSTEMS

MEASUREMENT SENSORS

STATIC CONTROL DEVICES

LASER MARKERS

PLC

HUMAN MACHINE INTERFACES

ENERGY MANAGEMENT SOLUTIONS

FA COMPONENTS

MACHINE VISION SYSTEMS

UV CURING SYSTEMS

Selection Guide

Fibers

Fiber Amplifiers

Other Products

**FX-500**

**FX-550**

**FX-100**

**FX-410**