

TeSys contactors

TeSys D, 4-pole contactors

For control in category AC-1, 20 to 200 A



LC1 DT20●●

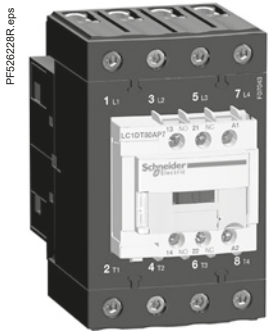

LC1 DT80A●●

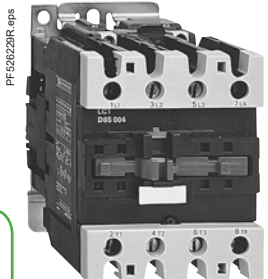

LC1 D65008●●

4-pole contactors for connection by screw clamp terminals or connectors					
Non inductive loads maximum current ($\theta \leq 60^\circ\text{C}$) utilisation category AC-1	Number of poles	Instantaneous auxiliary contacts		Basic reference, to be completed by adding the control voltage code ⁽¹⁾ Fixing ⁽²⁾	Weight ⁽³⁾

A **kg**

Connection by screw clamp terminals

20	4	–	1	1	LC1DT20●●	0.365
	2	2	1	1	LC1D098●●	0.365
25	4	–	1	1	LC1DT25●●	0.365
	2	2	1	1	LC1D128●●	0.365
32	4	–	1	1	LC1DT32●●	0.425
	2	2	1	1	LC1D188●●	0.425
40	4	–	1	1	LC1DT40●●	0.425
	2	2	1	1	LC1D258●●	0.425

Connection by EverLink®, BTR screw connectors

60	4	–	1	1	LC1DT60A●●	1.090
80	4	–	1	1	LC1DT80A●●	1.150

Connection by screw clamp terminals or connectors

60	2	2	–	–	LC1D40008●●	1.440
					or LP1D40008●●	2.210
80	2	2	–	–	LC1D65008●●	1.450
					or LP1D65008●●	2.220
125	4	–	–	–	LC1D80004●●	1.760
					or LP1D80004●●	2.685
	2	2	–	–	LC1D80008●●	1.840
					or LP1D80008●●	2.910
200	4	–	–	–	LC1D115004●●	2.860

4-pole contactors for connection by lugs or bars

In the references selected above, insert a figure 6 before the voltage code.

Example: LC1 DT20●● becomes LC1 DT206●●.

(1) Standard control circuit voltages (for other voltages, please consult your Regional Sales Office):

a.c. supply

Volts	24	42	48	110	115	220	230	240	380	400	415	440	500
LC1 D09...D150 and LC1 DT20...DT80A (LC1 D115 and D150 coils with built-in suppression device as standard)													
50/60 Hz	B7	D7	E7	F7	FE7	M7	P7	U7	Q7	V7	N7	R7	–
LC1 D80...D115													
50 Hz	B5	D5	E5	F5	FE5	M5	P5	U5	Q5	V5	N5	R5	S5
60 Hz	B6	–	E6	F6	–	M6	–	U6	Q6	–	–	R6	–

d.c. supply

Volts	12	24	36	48	60	72	110	125	220	250	440
LC1 D09...D25 and LC1 DT20...DT40 (coils with integral suppression device fitted as standard, by bi-directional peak limiting diode)											
U 0.75...1.25 Uc	JD	BD	CD	ED	ND	SD	FD	GD	MD	UD	RD
LC1 DT60A ...DT80A (coils with integral suppression device fitted as standard, by bi-directional peak limiting diode)											
U 0.75...1.25 Uc	JD	BD	CD	ED	ND	SD	FD	GD	MD	UD	RD
LP1D40...D80											
U 0.85...1.1 Uc	JD	BD	CD	ED	ND	SD	FD	GD	MD	UD	RD
U 0.75...1.2 Uc	JW	BW	CW	EW	–	SW	FW	–	MW	–	–
LC1 D115 (coil with built-in suppression device as standard)											
U 0.75...1.2 Uc	–	BD	–	ED	ND	SD	FD	GD	MD	UD	RD

Low consumption

Volts	5	12	20	24	48	110	220	250
LC1 D09...D25 and LC1 DT20...DT40 (coils with integral suppression device fitted as standard, by bi-directional peak limiting diode)								
U 0.8...1.25 Uc	AL	JL	ZL	BL	EL	FL	ML	UL

For other voltages between 5 and 690 V, see pages B8/32 to B8/35.

(2) LC1 D09 to D38 and LC1 DT20 to DT80A: clip-on mounting on 35 mm rail AM1 DP or screw fixing.

LC1 D80 ~: clip-on mounting on 35 mm rail AM1 DP or 75 mm rail AM1 DL or screw fixing.

LC1 or LP1 D80 ~: clip-on mounting on 75 mm rail AM1 DL or screw fixing.

LC1 D115 and D150: clip-on mounting on 2 x 35 mm rails AM1 DP or screw fixing.

(3) The weights indicated are for contactors with a.c. control circuit. For d.c. or low consumption control circuit, add 0.160 kg from LC1 D09 to D38, 0.075 kg from LC1 DT60A and D80A and 1 kg for LC1 D80.

Contactors

TeSys contactors

TeSys D, 4-pole contactors

For control in category AC-1, 20 to 80 A

4-pole contactors					
Non inductive loads maximum current ($\theta \leq 60^\circ\text{C}$) utilisation category AC-1	Number of poles	Instantaneous auxiliary contacts		Basic reference, to be completed by adding the voltage code ⁽¹⁾	Weight ⁽³⁾
				Fixing ⁽²⁾	
A					kg
Connection by spring terminals					
20	4 –	1	1	LC1DT203●●	0.380
	2 2	1	1	LC1D0983●●	0.380
25	4 –	1	1	LC1DT253●●	0.380
	2 2	1	1	LC1D1283●●	0.380
32	4 –	1	1	LC1DT323●●	0.425
	2 2	1	1	LC1D1883●●	0.425
40	4 –	1	1	LC1DT403●●	0.425
	2 2	1	1	LC1D2583●●	0.425
Connection by EverLink®, BTR screw connectors and control circuit by spring terminals					
60	4 –	1	1	LC1DT60A3●●	1.090
80	4 –	1	1	LC1DT80A3●●	1.150

Separate components

Auxiliary contact blocks and add-on modules: see pages B8/23 to B8/29.

⁽¹⁾ Standard control circuit voltages (for other voltages, please consult your Regional Sales Office):

a.c. supply

Volts	24	42	48	110	115	220	230	240	380	400	415	440	500
-------	----	----	----	-----	-----	-----	-----	-----	-----	-----	-----	-----	-----

LC1 D09...D25 and LC1 DT20...DT80A (coils with integral suppression device fitted as standard, by bi-directional peak limiting diode)

50/60 Hz	B7	D7	E7	F7	FE7	M7	P7	U7	Q7	V7	N7	R7	–
----------	----	----	----	----	-----	----	----	----	----	----	----	----	---

d.c. supply

Volts	12	24	36	48	60	72	110	125	220	250	440
-------	----	----	----	----	----	----	-----	-----	-----	-----	-----

LC1 D09...D25 and LC1 DT20...DT40 (coils with integral suppression device fitted as standard, by bi-directional peak limiting diode)

U 0.7...1.25 Uc	JD	BD	CD	ED	ND	SD	FD	GD	MD	UD	RD
-----------------	----	----	----	----	----	----	----	----	----	----	----

LC1 DT60A...80A (coils with integral suppression device fitted as standard, by bi-directional peak limiting diode)

U 0.75...1.25 Uc	JD	BD	CD	ED	ND	SD	FD	GD	MD	UD	RD
------------------	----	----	----	----	----	----	----	----	----	----	----

Low consumption

Volts	5	12	20	24	48	110	220	250
-------	---	----	----	----	----	-----	-----	-----

LC1 D09...D25 and LC1 DT20...DT40 (coils with integral suppression device fitted as standard, by bi-directional peak limiting diode)

U 0.8...1.25 Uc	AL	JL	ZL	BL	EL	FL	ML	UL
-----------------	----	----	----	----	----	----	----	----

For other voltages between 5 and 690 V, see pages B8/32 to B8/35.

⁽²⁾ LC1 D09 to D38 and LC1 DT20 to DT80A: clip-on mounting on 35 mm rail AM1DP or screw fixing.

⁽³⁾ The weights indicated are for contactors with a.c. control circuit. For d.c. or low consumption control circuit, add 0.160 kg from LC1 D09 to D38, 0.075 kg for LC1 DT60A and DT80A.

Contactors

TeSys contactors

TeSys D, 4-pole changeover contactor pairs for control in category AC-1, 20 to 200 A



LC2 DT20●●

Pre-assembled. Pre-wired power connections



For connection by screw clamp terminals or connectors

LC2 DT20 to LC2 DT40: mechanical interlock without electrical interlocking.

LC2 D80004: order separately 2 auxiliary contact blocks LAD N●1 to obtain electrical interlocking between the 2 contactors (see page B8/23).

For electrical interlocking incorporated in the mechanical interlock, please consult your Regional Sales Office.

LC2 D115004: mechanical interlock with integral, pre-wired electrical interlocking.

Utilisation category AC-1 Non-inductive loads Maximum rated operational current ($\theta \leq 60^\circ\text{C}$)	Instantaneous auxiliary contacts per contactor		Contactors supplied with coil	Weight kg
			Basic reference, to be completed by adding the voltage code ⁽¹⁾ Fixing ⁽²⁾	
A				kg
20	1	1	LC2DT20●●	0.730
25	1	1	LC2DT25●●	0.730
32	1	1	LC2DT32●●	0.850
40	1	1	LC2DT40●●	0.850
125	–	–	LC2D80004●●	3.200
200	–	–	LC2D115004●●	7.400

For connection by lugs or bars

20	1	1	LC2DT206●●	0.730
25	1	1	LC2DT256●●	0.730
32	1	1	LC2DT326●●	0.850
40	1	1	LC2DT406●●	0.850

For customer assembly

For connection by screw clamp terminals or connectors

60	1	1	LC1DT60A●● ⁽³⁾	–
80	1	1	LC1DT80A●● ⁽³⁾	–

For connection by lugs or bars

60	1	1	LC1DT60A6●● ⁽³⁾	–
80	1	1	LC1DT80A6●● ⁽³⁾	–

Auxiliary contact blocks and add-on modules: see pages B8/23 to B8/29.

Note: when assembling changeover contactor pairs, it is good practice to incorporate a 50 ms time delay.

⁽¹⁾ See note ⁽¹⁾ on next page.

⁽²⁾ LC2 DT20 to LC2 DT80: clip-on mounting on 35 mm \perp rail AM1 DP or screw fixing.

LC2 D80: clip-on mounting on 35 mm \perp rail AM1 DP or 75 mm \perp rail AM1 DL or screw fixing.

LC2 D115: clip-on mounting on 2 x 35 mm \perp rails AM1 DP or screw fixing.

⁽³⁾ For these operational currents, order 2 identical contactors and a mechanical interlock LAD 4CM (see page B8/30).

TeSys contactors

TeSys D, 4-pole changeover contactor pairs for control in category AC-1, 20 to 80 A

Pre-assembled. Pre-wired power connections

For connection by spring terminals.

Utilisation category AC-1 Non-inductive loads Maximum rated operational current ($\theta \leq 60^\circ\text{C}$)	Instantaneous auxiliary contacts per contactor 	Contactors supplied with coil Basic reference, to be completed by adding the control voltage code ⁽¹⁾ Fixing ⁽²⁾
---	--	--

A			
20	1	1	LC2DT203●●

For customer assembly

Power connection by EverLink®, BTR screw connectors ⁽³⁾ and control by spring terminals

60	1	1	LC1DT60A3●● ⁽⁴⁾
80	1	1	LC1DT80A3●● ⁽⁴⁾

Separate components

Auxiliary contact blocks and add-on modules: see pages B8/23 to B8/29.

⁽¹⁾ Standard control circuit voltages (for other voltages, please consult your Regional Sales Office):

a.c. supply

Volts	24	42	48	110	115	220	230	240	380	400	415	440	500
LC2 DT20...DT40, LC2 DT60A...DT80A													
50/60 Hz	B7	D7	E7	F7	FE7	M7	P7	U7	Q7	V7	N7	R7	-
LC2 D80004...D115004													
50 Hz	B5	D5	E5	F5	FE5	M5	P5	U5	Q5	V5	N5	R5	S5
60 Hz	B6	-	E6	F6	-	M6	-	U6	Q6	-	-	R6	-

d.c. supply

Volts	12	24	36	48	60	72	110	125	220	250	440
LC2 DT20...DT40, LC1 DT60...DT80 (coils with integral suppression device fitted as standard, by bi-directional peak limiting diode)											
U 0.7...1.25 U _c	JD	BD	CD	ED	ND	SD	FD	GD	MD	UD	RD

Low consumption

Volts	5	12	20	24	48	110	220	250
LC2 DT20...DT40 (coils with integral suppression device fitted as standard, by bi-directional peak limiting diode)								
U 0.8...1.25 U _c	AL	JL	ZL	BL	EL	FL	ML	UL

- For other voltages between 5 and 690 V, see pages B8/32 to B8/35.
- ⁽²⁾ Clip-on mounting on 35 mm rail **AM1 DP** or screw fixing.
- ⁽³⁾ BTR screws: hexagon socket head. In accordance with local electrical wiring regulations, a size 4 insulated Allen key must be used (reference **LAD ALLEN4**, see page B8/29).
- ⁽⁴⁾ For these operational currents, order 2 identical contactors and a mechanical interlock **LAD 4CM** (see page B8/30).

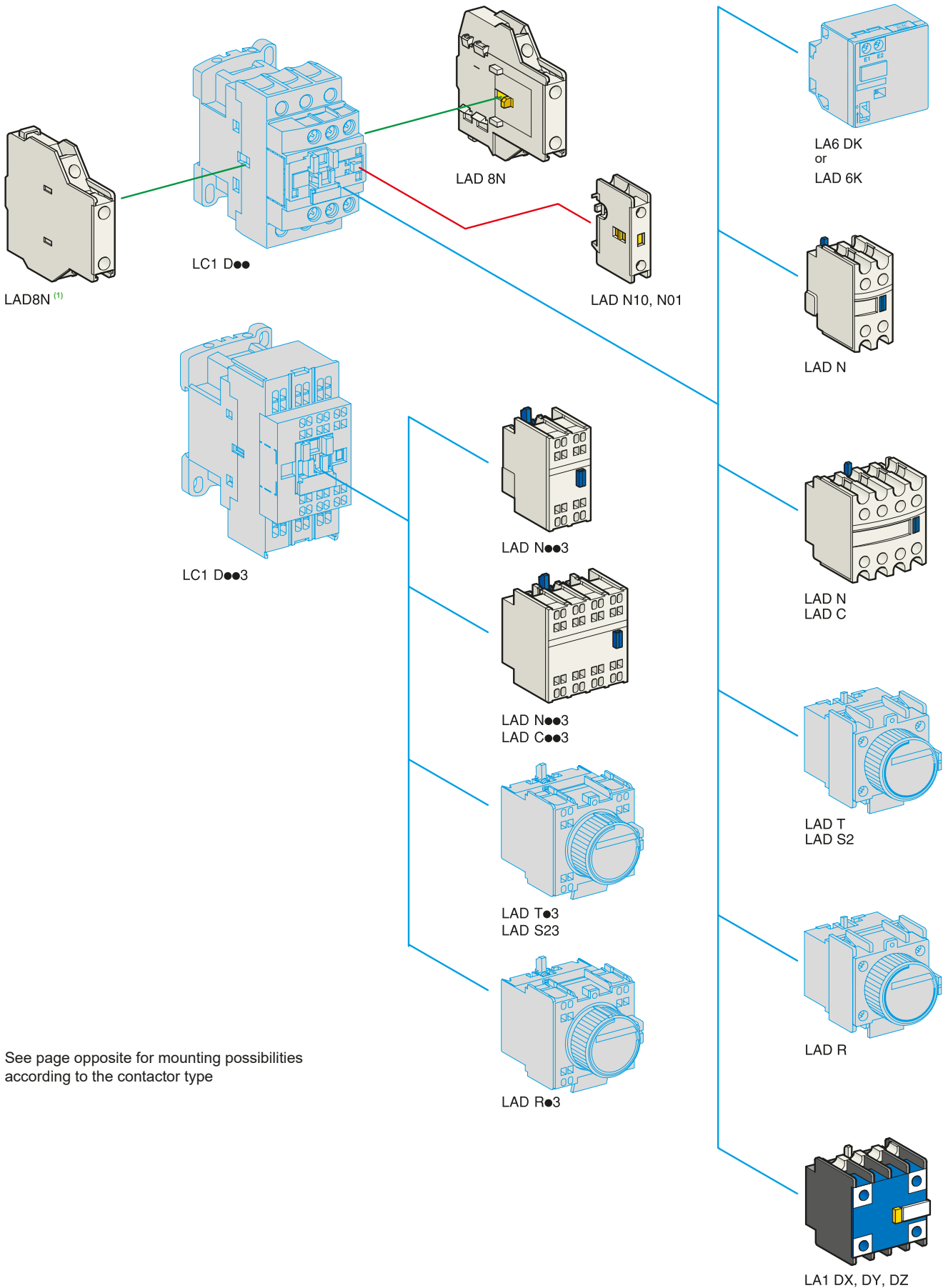

See page opposite for mounting possibilities according to the contactor type

(1) No left side mounting on TeSys D Green contactors.





TeSys contactors

TeSys D contactors and reversing contactors

Instantaneous auxiliary contact blocks

Instantaneous auxiliary contact blocks for connection by screw clamp terminals

For use in normal operating environments

Clip-on mounting	Number of contacts per block	Composition					Reference
							
Front	1	-	-	-	1	-	LADN10
		-	-	-	-	1	LADN01
	2	-	-	-	1	1	LADN11
		-	-	-	2	-	LADN20
	4	-	-	-	-	2	LADN02
		-	-	-	2	2	LADN22 LADN22S ⁽⁴⁾
		-	-	-	1	3	LADN13
		-	-	-	4	-	LADN40
		-	-	-	-	4	LADN04
		-	-	-	3	1	LADN31
4 incl. 1 N/O & 1 N/C make before break	-	-	-	2	2	LADC22	
Side (contact blocks compatible with AC coil contactors only)	2	-	-	-	1	1	LAD8N11
		-	-	-	2	-	LAD8N20
		-	-	-	-	2	LAD8N02

For terminal referencing conforming to EN 50012

Front on 3P contactors and 4P contactors 20 to 80 A	2	-	-	-	1	1	LADN11G
	4	-	-	-	2	2	LADN22G
Front on 4P contactors 125 to 200 A	2	-	-	-	1	1	LADN11P
	4	-	-	-	2	2	LADN22P

With dust and damp protected contacts, for use in particularly harsh industrial environments

Front	2	-	2	-	-	-	LA1DX20
		1	1	-	-	-	LA1DX11
		2	-	-	-	-	LA1DX02
		-	2	2	-	-	LA1DY20 ⁽²⁾
		-	2	-	2	-	LA1DZ40
4	-	2	-	1	1	LA1DZ31	

Instantaneous auxiliary contact blocks for connection by lugs

This type of connection is not possible for blocks with 1 contact or blocks with dust and damp protected contacts. For all other instantaneous auxiliary contact blocks, add the figure 6 to the end of the references selected above. Example: LAD N11 becomes LAD N116.

Instantaneous auxiliary contact blocks for connection by spring terminals

This type of connection is not possible for LAD 8, LAD N with 1 contact or blocks with dust and damp protected contacts. For all other contact blocks, add the figure 3 to the end of the references selected above. Example: LAD N11 becomes LAD N113.

Instantaneous auxiliary contact blocks for connection by Faston connectors

This type of connection is not possible for LAD 8, LAD N with 1 contact or blocks with dust and damp protected contacts. For all other contact blocks, add the figure 9 to the end of the references selected above. Example: LAD N11 becomes LAD N119.

Maximum number of auxiliary contacts that can be fitted:

Contactors	Type	Number of poles and size	Instantaneous auxiliary contacts				Time delay Front mounted
			Side mounted	Front mounted			
				1 contact	2 contacts	4 contacts	
AC	3P	LC1 D09...D38	1 on LH or 1 on RH side ⁽¹⁾ and	-	1	or 1	or 1
AC/DC		LC1 D40A...D80A	1 on LH or 1 on RH side and	-	1	or 1	or 1
		LC1 D80 and D95 (50/60 Hz)	1 on each side or	2	and 1	or 1	or 1
		LC1 D80 and D95 (50 or 60 Hz)	1 on each side and	2	and 1	or 1	or 1
		LC1 D115 and D150	1 on LH side and	-	1	or 1	or 1
		LC1 DT20...DT40	1 on LH side and	-	1	or 1	or 1
	4P	LC1 DT60A and DT80A	1 on LH or 1 on RH side and	-	1	or 1	or 1
		LC1 D40008, D65008 and D80	1 on each side or	1	or 1	or 1	or 1
		LC1 D115	1 on each side and	1	or 1	or 1	or 1
		LC1 D09...D38	-	-	1	or 1	or 1
		LC1 D40A...D80A	-	-	1	or 1	or 1
DC	3P	LC1 D80 and D95	-	1	or 1	or 1	or 1
		LC1 D115 and D150	1 on LH side and	-	1	or 1	or 1
		LC1 DT20...DT40	-	-	1	or 1	or 1
		LC1 DT60A and DT80A	-	-	1	or 1	or 1
		LC1 D40008, D65008 and D80	-	2	and 1	or 1	or 1
	4P	LC1 D115	1 on each side	-	and 1	or 1	or 1
LC ⁽³⁾⁽⁵⁾	3P	LC1 D09...D38	-	-	1	-	-
	4P	LC1 DT20...DT40	-	-	1	-	-

⁽¹⁾ 1 on LH side for AC coils - 1 on RH side for AC/DC coils. ⁽⁴⁾ With red front face - for safety chain indication.

⁽²⁾ Device fitted with 4 earth screen continuity terminals.

⁽⁵⁾ LA1D●●● dust & damp proof auxiliary contact blocks not allowed.

⁽³⁾ LC: low consumption.

TeSys contactors

TeSys D contactors and reversing contactors

Time delay auxiliary contact blocks Mechanical latch blocks

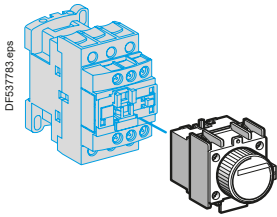

LAD T●

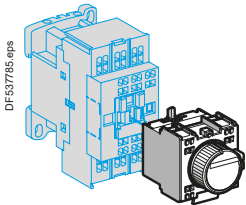

LAD T●3

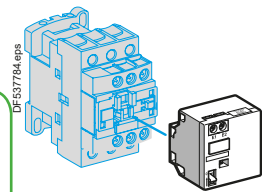

LAD 6K10●

Contactors

Time delay auxiliary contact blocks for connection by screw clamp terminals

Maximum number of auxiliary contact blocks that can be fitted per contactor, see page B8/23.

Sealing cover to be ordered separately, see page B8/29.

LAD T0 and LAD R0: with extended scale from 0.1 to 0.6 s.

LAD S2: with switching time of 40 ms ± 15 ms between opening of the N/C contact and closing of the N/O contact.

Clip-on mounting	Number of contacts	Time delay		Reference
		Type	Setting range	
Front	1 N/O + 1 N/C	On-delay	0.1...3 s	LADT0
			0.1...30 s	LADT2
			10...180 s	LADT4
		Off-delay	1...30 s	LADS2
			0.1...3 s	LADR0
			0.1...30 s	LADR2
		10...180 s	LADR4	

Time delay auxiliary contact blocks for connection by lugs

Add the figure 6 to the end of the references selected above. Example: LAD T0 becomes LAD T06.

Time delay auxiliary contact blocks for connection by spring terminals

Add the figure 3 to the end of the references selected above. Example: LAD T0 becomes LAD T03.

Time delay auxiliary contact blocks for connection by Faston connectors

Add the figure 9 to the end of the references selected above. Example: LAD T0 becomes LAD T09.

Mechanical latch blocks ⁽¹⁾

Clip-on mounting	Unlatching control	For use on contactor	Basic reference, to be completed by adding the control voltage code ⁽²⁾
Front	Manual or electric	LC1 D09...D38 (~ or ---) ⁽³⁾	LAD6K10●
		LC1 DT20...DT40 (~ or ---)	LAD6K10●
		LC1 D40A...D80A (3 P ~ or ---)	LAD6K10●
		LC1 DT60A and DT80A (4 P ~ or ---)	LAD6K10●
		LC1 D80...D150 (3 P ~)	LA6DK20●
		LC1 D80 and D115 (3 P ---)	LA6DK20●
		LC1 D80 (4 P ~)	LA6DK20●
		LC1 D80 and D115 (4 P ~)	LA6DK20●
		LP1 D80 and LC1 D115 (4 P ---)	LA6DK20●

⁽¹⁾ The mechanical latch block must not be powered up at the same time as the contactor.

The duration of the control signal for the mechanical latch block and the contactor should be: ≥ 100 ms for a contactor operating on an a.c. supply, ≥ 250 ms for a contactor operating on a d.c. supply.

Maximum impulse duration for the LAD 6K10● mechanical latch block: 10 seconds.

⁽²⁾ Standard control circuit voltages (for other voltages, please consult your Regional Sales Office):

Volts 50/60 Hz, 24	32/36	42/48	60/72	100	110/127	220/240	256/277	380/415	

Code	B	C	E	EN	K	F	M	U	Q

⁽³⁾ The DC, low consumption contactors (coil code ●L) are not compatible with the mechanical latch blocks LAD6K10●.

TeSys contactors

TeSys D contactors and reversing contactors

Suppressor modules

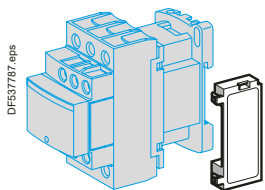

LAD 4••

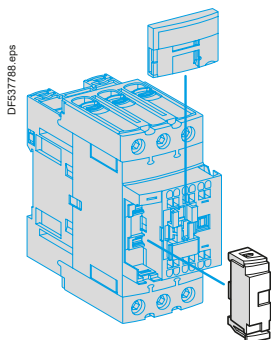

LAD 4RC3•, LAD 4V3•,
LAD 4D3U, LAD 4T3•

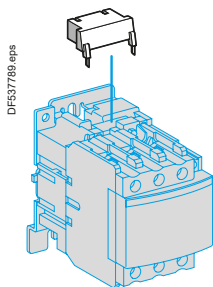

LA4 D••

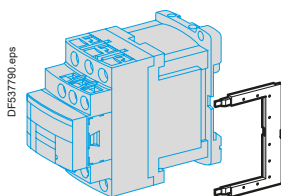

LAD 4DDL or LAD 4T•DL

RC circuits (Resistor-Capacitor)

Effective protection for circuits highly sensitive to "high frequency" interference. For use only in cases where the voltage is virtually sinusoidal. i.e. less than 5 % total harmonic distortion. Voltage limited to 3 Uc max. and oscillating frequency limited to 400 Hz max. Slight increase in drop-out time (1.2 to 2 times the normal time).

Mounting	For use with contactor ⁽¹⁾ Rating	Type		Reference
		V~	V---	
Clip-on side mounting ⁽³⁾⁽⁵⁾	D09...D38 (3P) DT20...DT40	24...48	-	LAD4RCE
		50...127	-	LAD4RCG
		110...250	-	LAD4RCU
Clip-on front mounting ⁽³⁾⁽⁵⁾	D40A...D65A (3P) DT60A...DT80A (4P)	24...48	-	LAD4RC3E
		50...127	-	LAD4RC3G
		110...240	-	LAD4RC3U
		380...415	-	LAD4RC3N
Screw fixing ⁽⁴⁾	D80...D150 (3P) D40...D115 (4P)	24...48	-	LA4DA2E
		50...127	-	LA4DA2G
		110...240	-	LA4DA2U
		380...415	-	LA4DA2N

Varistors (peak limiting)

Protection provided by limiting the transient voltage to 2 Uc max. Maximum reduction of transient voltage peaks. Slight increase in drop-out time (1.1 to 1.5 times the normal time).

Clip-on side mounting ⁽³⁾⁽⁵⁾	D09...D38 (3P) DT20...DT40	24...48	-	LAD4VE
		50...127	-	LAD4VG
		110...250	-	LAD4VU
Clip-on front mounting ⁽³⁾⁽⁵⁾	D40A...D65A (3P) DT60A...DT80A (4P)	24...48	24...48	LAD4V3E
		50...127	50...127	LAD4V3G
		110...250	110...250	LAD4V3U
		380...415	-	LAD4V3N
Screw fixing ⁽⁴⁾	D80...D115 (3P) D80...D115 (4P)	24...48	-	LA4DE2E
		50...127	-	LA4DE2G
		110...250	-	LA4DE2U
	D80...D95 (3P) D80 (4P)	-	24...48	LA4DE3E
		-	50...127	LA4DE3G
		-	110...250	LA4DE3U

Flywheel diodes

No overvoltage or oscillating frequency. Increase in drop-out time (6 to 10 times the normal time). Polarised component.

Clip-on side mounting ⁽⁵⁾	D09...D38 (3P), DT20...DT40	-	5...600	LAD4DDL
Clip-on front mounting ⁽⁵⁾	D40A...D65A (3P), DT60A...DT80A (4P)	-	24...250	LAD4D3U
Screw fixing ⁽⁴⁾	D80 and D95 (3P), D40...D80 (4P)	-	24...250	LA4DC3U

Bidirectional peak limiting diodes

Protection provided by limiting the transient voltage to 2 Uc max. Maximum reduction of transient voltage peaks.

Clip-on side mounting ⁽³⁾	D09...D38 (3P) DT20...DT40 (4P) ⁽²⁾	24	-	LAD4TB
		-	24	LAD4TBDL
		72	-	LAD4TS
		-	72	LAD4TSDL
		-	125	LAD4TGDL
		-	250	LAD4TUDL
Clip-on front mounting ⁽³⁾	D40A...D65A (3P) DT60A...DT80A (4P) ⁽²⁾	-	600	LAD4TXDL
		12...24	12...24	LAD4T3B
		25...72	25...72	LAD4T3S
		73...125	73...125	LAD4T3G
		126...250	126...250	LAD4T3U
		251...440	251...440	LAD4T3R
Screw fixing ⁽⁴⁾	D80...D95 (3P) D40...D80 (4P)	12...24	-	LA4DB2B
		25...72	-	LA4DB2S
		-	24	LA4DB3B
		-	72	LA4DB3S

(1) For satisfactory protection, a suppressor module must be fitted across the coil of each contactor except for TeSys D Green (••E coil), as surge protection is already embedded.

(2) From D09 to D65A and from LC1 DT20 to DT80A, d.c. low consumption or TeSys D Green 3-pole contactors are fitted with a built-in bidirectional peak limiting diode suppressor as standard. This bidirectional peak limiting diode is removable and can therefore be replaced by the user. (See reference above). If a d.c. or low consumption contactor is used without suppression, the standard suppressor should be replaced with a blanking plug (reference LAD 9DL for LC1 D09 to D38 and LC1 DT20 to DT40; reference LAD 9DL3 for LC1 D40A to D65A and LC1 DT60A to DT80A).

(3) Clipping-on makes the electrical connection. The overall size of the contactor remains unchanged.

(4) Mounting at the top of the contactor on coil terminals A1 and A2.

(5) In order to install these accessories, the existing suppression device must first be removed.

Contactors

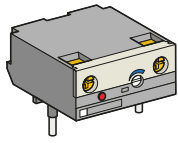

LA4 DT

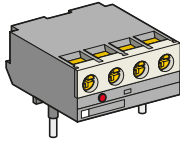

LA4 DFB⁽¹⁾

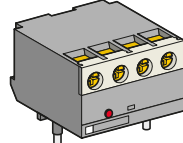

LA4 DWB

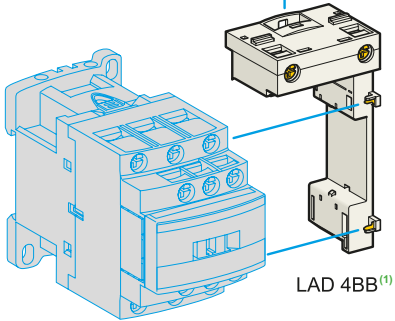

LC1 D09...D38

LAD 4BB⁽¹⁾

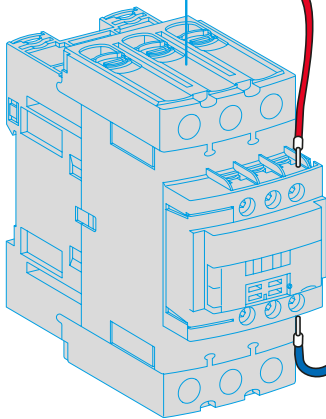

LC1 D40A...D80A

LAD 4BB3

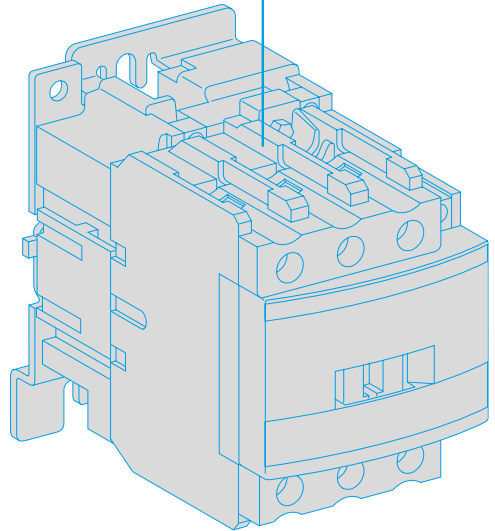

LC1 D80...D95

Contactors

See page opposite for mounting possibilities according to the contactor type.

⁽¹⁾ For TeSys D with AC coil only.

TeSys contactors

TeSys D contactors and reversing contactors

Accessories

Electronic serial timer modules ⁽¹⁾

- 3-pole contactors LC1 D09 to D38: mounted using adapter LAD 4BB, to be ordered separately, see below.
- 3-pole contactors LC1 D40A to D65A: mounted using adapter LAD 4BB3, to be ordered separately, see below.
- 3-pole contactors LC1 D80 to D150 and 4-pole contactors LC1 D40 to D115: mounted directly across terminals A1 and A2 of the contactor.

On-delay type

Operational voltage \sim		Time delay	Reference
24...250 V	100...250 V		
LC1 D09...D80A (3P)	LC1 D80...D150 (3P)	0.1...2 s	LA4DT0U
		1.5...30 s	LA4DT2U
		25...500 s	LA4DT4U

Interface modules

- 3-pole contactors LC1 D09 to D38: mounted using adapter LAD 4BB, to be ordered separately, see below.
- 3-pole contactors LC1 D40A to D80A: mounted using adapter LAD4 BB3, to be ordered separately, see below.

Relay interface

Operational voltage \sim		Supply voltage E1-E2 (---)	Reference
24...250 V			
LC1 D09...D150 (3P)		24 V	LA4DFB

Static relay interface

Operational voltage \sim		Supply voltage E1-E2 (---)	Reference
24...250 V	100...250 V		
LC1 D09...D80A (3P)	LC1 D80...D115 (3P)	24 V	LA4DWB

Adapter kit for low control signal

For use on contactors	Composition	Reference
LC1 D40A...D80A (3P) ⁽²⁾	<ul style="list-style-type: none"> ■ 1 LAD4BB3 coil wiring adapter ■ 1 LA4DFB relay interface module 	LA4DBL

Wiring adapters for coil retrofit of 3 pole contactors

For adapting existing wiring to a new product

For use on contactors		Reference	
LC1 D09...D38	Without coil suppression	LAD4BB ⁽³⁾	
	With coil suppression	\sim 24...48 V	LAD4BBVE
		\sim 50...127 V	LAD4BBVG
		\sim 110...250 V	LAD4BBVU
LC1 D40A...80A	Without coil suppression	LAD4BB3	

⁽¹⁾ For 24 V operation, the contactor must be fitted with a 21 V coil (code Z).
See pages B8/32 to B8/35.

⁽²⁾ The kit is compatible with a coil voltage of \sim 24 V to \sim 250 V (B7 to U7) and --- 24 V to --- 250 V (BD to UD).

⁽³⁾ LAD4BB can not be used with 4 poles contactors.

TeSys contactors

TeSys D contactors and reversing contactors

Accessories

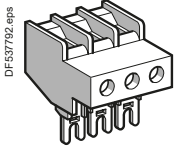

LA9 D3260

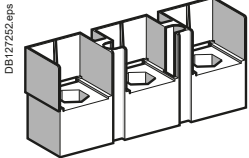

LA9 D11550

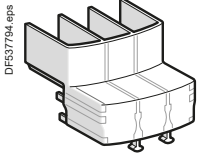

LA9 D11550

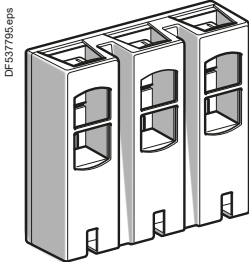

LA9 D11560

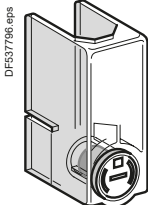

LA9 D11570

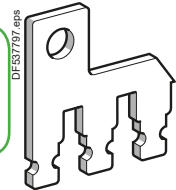

LA9 D80962

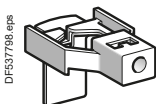

LA9 D11567

Accessories for main pole and control connections

Description	For use with contactors LC1		Sold in lots of	Unit reference
	~	---		
Connectors for cable, size (1 connector)	4-pole 10 mm ²	DT20, DT25	DT20, DT25	1 LAD92560
	3-pole 25 mm ²	D09...D38	D09...D38	1 LA9D3260
EverLink® terminal block	3-pole	D40A...D80A	D40A...D80A	1 LAD96560
Connectors for cables (2 connectors)	3-pole 120 mm ²	D115, D150	D115, D150	1 LA9D115603
	4-pole 120 mm ²	D115	D115	1 LA9D115604
Connectors for lug type terminals (2 connectors)	3-pole	D1156, D1506	D1156, D1506	1 LA9D115503
	4-pole	D1156	D1156	1 LA9D115504
Protective covers for connectors for lug type terminals	3-pole	D40A6...D80A6	D40A6...D80A6	1 LAD96570
		D1156, D1506	D1156, D1506	1 LA9D115703 ⁽¹⁾
	4-pole	D60A6...D80A6	D60A6...D80A6	1 LAD96580
		D1156, D1506	D1156, D1506	1 LA9D115704
IP 20 covers for lug type terminals (for mounting with circuit breakers GV3 P●●6 and GV3 L●●6)	3 poles	D40A6...D80A6	D40A6...D80A6	1 LAD96575
Links for parallel connection of	2 poles	D09...D38	D09...D38	10 LA9D2561
		DT20, DT25 (4P)	DT20, DT25 (4P)	10 LA9D1261
		DT32, DT40 (4P)	DT32, DT40 (4P)	10 LAD96061
		D40A...D80A	D40A...D80A	1 LAD9P32
		D80, D95	D80, D95	2 LA9D80961
	3 poles	D09...D38	D09...D38	10 LAD9P3 ⁽²⁾
		D40A...D80A	D40A...D80A	1 LAD9P33
	4 poles	D80, D95	D80, D95	1 LA9D80962
		DT20, DT25	DT20, DT25	2 LA9D1263
		D80	D80	2 LA9D80963
Staggered coil connection	–	D80	10 LA9D09966	
Control circuit take-off from main pole	D80, D95	D80, D95	10 LA9D8067	
	D115, D150	D115, D150	10 LA9D11567	
Spreaders for increasing the pole pitch to 45 mm	D115, D150	D115, D150	3 GV7AC03	

(1) For 3-pole contactors: 1 set of 6 covers, for 4-pole contactors: 1 set of 8 covers.

(2) Separate connecting bar for connecting 2 poles in parallel.

Contactors

TeSys contactors

TeSys D contactors and reversing contactors

Accessories

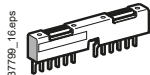

GV2 G245

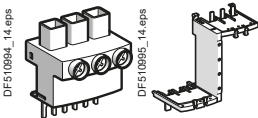

GV1 G09 GV3 S

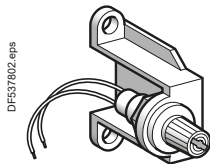

LA9 D941

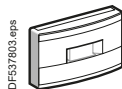

LAD 9ET•

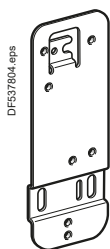

LAD 7X3

Sets of contacts and arc chambers

Description	For contactor	Reference	
Sets of contacts	3-pole	LC1 D115	LA5D1158031
		LC1 D150	LA5D150803
Arc chambers	4-pole	LC1 D115004	LA5D115804
		3-pole	LC1 D115
	4-pole	LC1 D150	LA5D15050
		LC1 D115004	LA5D115450

Power connection accessories

Terminal block	For supply to one or more GV2 G busbar sets	GV1G09
Set of 63 A busbars for parallelling of contactors	2 contactors LC1 D09...D18 or D25...D38	GV2G245
	4 contactors LC1 D09...D18 or D25...D38	GV2G445
Set of 115 A busbars for parallelling of contactors	2 contactors LC1 D40A...D80A	GV3G264
	3 contactors LC1 D40A...D80A	GV3G364 ⁽¹⁾
Set of S-shape busbars	For circuit breakers GV3 P●● and GV3 L●● ⁽³⁾ and contactors LC1 D40A...D73A	GV3S

Protection accessories

Description	Use	Sold in lots of	Reference
Miniature control circuit fuse holder	5 x 20 with 4 A-250 V fuse	1	LA9D941
Sealing cover	For LAD T, LAD R	1	LA9D901
Safety cover preventing access to the moving contact carrier	LC1 D09...D80A and DT20...DT80A	1	LAD9ET1
	Red cover (for safety chain indication)	1	LAD9ET1S
	LC1 D80 and D95	1	LAD9ET3
	Red cover (for safety chain indication)	1	LAD9ET3S
	LC1 D115 and D150	1	LAD9ET4
	Red cover (for safety chain indication)	1	LAD9ET4S

Marking accessories

Description	Use	Sold in lots of	Unit reference
Sheet of 64 blank legends, self-adhesive, 8 x 33 mm ⁽²⁾	Contactors (except 4P) LC1 D80...D115, LAD N (4 contacts), LA6 DK	10	LAD21
Sheet of 112 blank legends, self-adhesive, 8 x 12 mm ⁽²⁾	LAD N (2 contacts), LAD T, LAD R, LRD	10	LAD22
Sheet of 64 blank legends for marking using plotter or 8 x 33 mm engraver	Contactors (except 4P) LC1 D80...D115, LAD (4 contacts), LA6 DK	10	LAD23
Sheet of 440 blank legends for marking using plotter or 8 x 12 mm engraver	All products	35	LAD24
Marker holder snap-in, 8 x 22 mm	4-pole contactors, LC1 D80...D115, LA6 DK	100	LA9D92
Marker holder snap-in, 8 x 18 mm	LC1 D09...D65A, LC1 DT20...DT80A, LAD N (4 contacts), LAD T, LAD R	100	LAD90
Bag of 300 blank legends self-adhesive, 7 x 21 mm	On holder LA9 D92	1	LA9D93

Mounting accessories

Retrofit plate for screw fixing	For replacement of LC1 D40 to D80 with LC1 D40A to D80A	1	LAD7X3
Mounting plate	For replacement of LC1 F115 or F150 with LC1 D115 or D150	1	LA9D730
Size 4 Allen key, insulated, 1000 V	For use on contactors LC1 D40A to LC1 D150	5	LADALLEN4

⁽¹⁾ With this set of busbars, any one contactor can be supplied directly by its EverLink® double cage power terminal block. The other two contactors are supplied by the busbar set. The 115 A limitation is therefore applied to these two contactors. Example: 1 LC1 D65A supplied directly + 1 contactor LC1 D65A and 1 contactor LC1 D50 A supplied via the busbar set = 115 A. This combination is compatible with busbar set GV3 G364.

⁽²⁾ These legends are for sticking onto the safety cover of the contactors or add-on block, if fitted.

⁽³⁾ With 73 A current limit for GV3L73, GV3P73.

Contactors

TeSys contactors

Component parts for assembling reversing contactors for motor control, low-speed/high-speed starters and star-delta starters

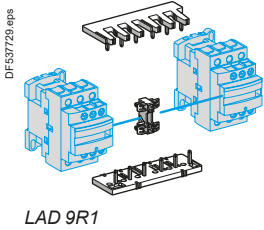

LAD 9R1

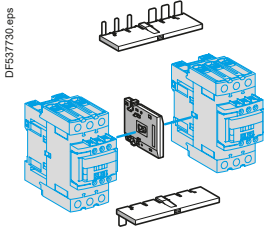

LAD 9R3

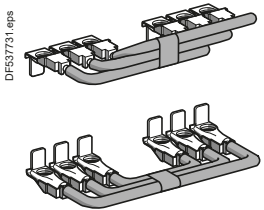

LA9 D8069

For 3-pole reversing contactors for motor control

Contactors with screw clamp terminals or connectors. Horizontally mounted, assembled by customer.

Description	For contactors ⁽¹⁾ (2 identical contactors)	Reference
Kits for assembly of reversing contactors		
Kit comprising: ■ a mechanical interlock LAD 9V2 with electrical interlocking LAD 9V1 ■ a set of power connections LAD 9V5 (parallel) and LAD 9V6 (reversing).	LC1 D09 to D38	LAD9R1V
Kit comprising: ■ a mechanical interlock LAD 9V2 without electrical interlocking ■ a set of power connections LAD 9V5 (parallel) and LAD 9V6 (reversing).	LC1 D09 to D38	LAD9R1
Kit comprising: ■ a mechanical interlock LAD 4CM ■ a set of power connections LA9 D65A69 .	LC1 D40A to D80A	LAD9R3
Mechanical interlocks		
Mechanical interlock with integral electrical interlocking	LC1 D80 and D95 (∩)	LA9D4002
	LC1 D80 and D95 (∩∩)	LA9D8002
	LC1 D115 and D150	LA9D11502
Mechanical interlock without integral electrical interlocking	LC1 D09 to D38	LAD9V2
	LC1 D40A to D80A	LAD4CM
	LC1 D80 and D95 (∩)	LA9D50978
	LC1 D80 and D95 (∩∩)	LA9D80978
	LC1 D115 and D150	LA9D11569
Sets of power connections		
Comprising: ■ a set of parallel bars ■ a set of reverser bars.	LC1 D09 to D38 with screw clamp terminals or connectors	LAD9V5 + LAD9V6
	LC1 D09...D32 with spring terminal connections	LAD9V12 + LAD9V13 ⁽²⁾
	LC1 D40A to D80A	LA9D65A69
	LC1 D80 and D95 (∩)	LA9D8069
	LC1 D80 and D95 (∩∩)	LA9D8069
LC1 D115 and D150	LA9D11569	

For low-speed/high-speed starter

Description	For LC1D09... D38 contactors with connection type	Reference
Connection kit enabling reversing of low and high speed directions using a reversing contactor and a 2N/O + 2N/C main pole contactor	Screw clamps or connectors	LAD9PVG V
	Spring terminals	LAD3PVG V

For star-delta starter

Description	For contactors	Reference	Without timer LADS2
Mounting kit comprising: ■ 1 time delay contact block LAD S2 (LC1 D09...D80) , ■ power circuit connections (LC1 D09...D80), ■ hardware required for fixing the contactors onto the mounting plate (LC1 D80).	LC1 D09 to D38 ⁽³⁾	LAD91217	LAD91218
	LC1 D09 to D38 ⁽⁴⁾	LAD93217	LAD93218
	LC1 D40A to D65A	LAD9SD3	-
	LC1 D80	LA9D8017	-
Equipment mounting plates	LC1 D09 to D38	LA9D12974	
	LC1 D40A and D50A	-	
	LC1 D80	LA9D80973	

(1) To order the 2 contactors: see pages B8/3 and B8/16.
 (2) To assemble a reversing contactor with spring terminal connections, the following components must be ordered:
 - 1 mechanical interlock **LAD 9V2**,
 - 1 upstream power connection kit and 1 downstream power connection kit.
 Upstream power connection kit **LAD 9V10**: installed in the Quickfit system with power connection module **LAD 34**.
 (If module **LAD 34** is not used, replace **LAD 9V10** with **LAD 9V12**).
 Downstream power connection kit **LAD 9V11**: installed in the Quickfit system with outgoing terminal block **LAD 331**.
 (If **LAD 331** is not used, replace **LAD 9V11** with **LAD 9V13**).
 (3) For assembly of 3 contactors of the same physical size (depth).
 (4) For assembly of 3 contactors with star contactor physically smaller (depth).

TeSys contactors

Component parts for assembling changeover contactor pairs

For 4-pole changeover contactor pairs (3-phase distribution + neutral)

Contactors with screw clamp terminals or connectors. Horizontally mounted, assembled by customer.

Description	For contactors ⁽¹⁾ (2 identical contactors)	Reference
-------------	---	-----------

Kits for assembly of changeover contactor pairs

Kit comprising: ■ a mechanical interlock LAD 9V2 with electrical interlocking LAD 9V1, ■ a set of power connections (changeover) LAD 9V7.	LC1 DT20 to DT40 with screw clamps or connectors	LADT9R1V
---	--	-----------------

Kit comprising: ■ a mechanical interlock LAD 9V2 without electrical interlocking, ■ a set of power connections (changeover) LAD 9V7.	LC1 DT20 to DT40 with screw clamps or connectors	LADT9R1
--	--	----------------

Mechanical interlocks

With integral electrical interlocking	LC1 D80004	LA9D4002
	LP1 D80004	LA9D8002
	LC1 D115004	LA9D11502

Without integral electrical interlocking	LC1 DT20 to DT40 with screw clamps or connectors	LAD9V2 ⁽²⁾
	LC1 DT203 to DT403 with spring terminals	LAD9V2 ⁽²⁾
	LC1 DT60A and DT80A	LAD4CM
	LC1 D80004	LA9D50978
	LP1 D80004	LA9D80978

Sets of power connections

Comprising a set of parallel bars	LC1 D80004	LA9D8070
	LP1 D80004	LA9D8070
	LC1 D115004	LA9D11570
	LC1 DT203 to DT403 with spring terminals	LAD9V9
	LC1 D80004	LA9D8070 ⁽²⁾
	LP1 D80004	LA9D8070 ⁽²⁾

For 3-pole changeover contactor pairs

Contactors with screw clamp terminals or connectors. Horizontally mounted, assembled by customer.

Description	For contactors ⁽¹⁾ (2 identical contactors)	Reference
-------------	---	-----------

Kits for assembly of changeover contactor pairs

Kit comprising: ■ a mechanical interlock LAD4CM ■ a set of parallel bars LA9D65A6	LC1 D40A...D80A	LAD9R3S
---	-----------------	----------------

Mechanical interlocks

Without integral electrical interlocking	LC1 D40A...D80A	LAD4CM
With integral electrical interlocking	LC1 D115 and D150	LA9D11502

Sets of power connections

Comprising a set of parallel bars	LC1 D40A...D80A	LA9D65A6
	LC1 D115 and D150	LA9D11571

⁽¹⁾ To order the 2 contactors: see pages B8/3 and B8/16.

⁽²⁾ Order 2 contact blocks **LAD N•1** to build the electrical interlock, see page B8/23.

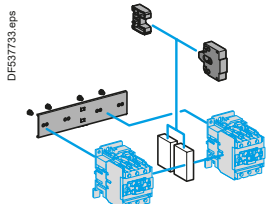

LA9 D50978

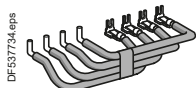

LA9 D6570

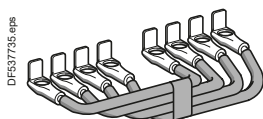

LA9 D8070

Contactors

TeSys contactors

a.c. coils for TeSys D, 3 or 4-pole contactors

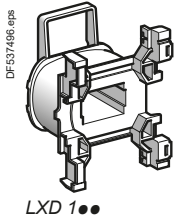

For ~ contactors LC1 D09...D38 and LC1 DT20...DT40

Specifications

Average consumption at 20 °C:

■ inrush ($\cos \phi = 0.75$) 70 VA,■ sealed ($\cos \phi = 0.3$) 50 Hz: 7 VA, 60 Hz: 7.5 VA.Operating range ($\theta \leq 60$ °C): 50 Hz: 0.8...1.1 Uc, 60 Hz: 0.85...1.1 Uc.

Control circuit voltage Uc	Average resistance at 20 °C ± 10 %	Inductance of closed circuit	Reference ⁽¹⁾
V	Ω	H	
			50/60 Hz
12	1.33	0.05	LXD1J7
21 ⁽²⁾	4.17	0.17	LXD1Z7
24	5.37	0.22	LXD1B7
32	10.1	0.39	LXD1C7
36	12.8	0.49	LXD1CC7
42	17	0.67	LXD1D7
48	21.7	0.87	LXD1E7
60	34.6	1.4	LXD1EE7
100	100.4	3.8	LXD1K7
110	124.1	4.6	LXD1F7
115	129.8	5	LXD1FE7
120	150.6	5.4	LXD1G7
127	158.5	6.1	LXD1FC7
200	410.7	15	LXD1L7
208	430.4	16	LXD1LE7
220	515.4	18	LXD1M7 ⁽³⁾
230	538.6	20	LXD1P7
240	562.3	22	LXD1U7
277	800.7	29	LXD1W7
380	1551	55	LXD1Q7 ⁽⁴⁾
400	1633	60	LXD1V7
415	1694	65	LXD1N7
440	1993	73	LXD1R7
480	2398	87	LXD1T7
500	2499	95	LXD1S7
575	3294	125	LXD1SC7
600	3810	136	LXD1X7
660	4656	165	LXD1YC7
690	5020	180	LXD1Y7

⁽¹⁾ The last 2 digits in the reference represent the voltage code.⁽²⁾ Voltage for special coils fitted in contactors with serial timer modules, with 24 V supply.⁽³⁾ Suitable for use on 230 V / 50 Hz. In this case, apply a coefficient of 0.6 to the mechanical durability of the contactor (see page B8/62 and B8/64).⁽⁴⁾ Suitable for use on 400 V / 50 Hz. In this case, apply a coefficient of 0.6 to the mechanical durability of the contactor (see page B8/62 and B8/64).

TeSys contactors

a.c. coils for TeSys D, 3 or 4-pole contactors

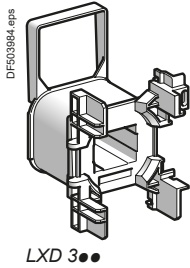

For ~ contactors LC1 D40A...D80A, LC1 DT60A and LC1 DT80A

Specifications

Average consumption at 20 °C:

■ inrush ($\cos \phi = 0.75$) 160 VA,■ sealed ($\cos \phi = 0.3$) 50 Hz: 15 VA, 60 Hz: 15 VA.Operating range ($\theta \leq 60$ °C): 50 Hz: 0.8...1.1 Uc, 60 Hz: 0.85...1.1 Uc.

Control circuit voltage Uc	Average resistance at 20 °C $\pm 10\%$	Inductance of closed circuit	Reference ⁽¹⁾
V	Ω	H	
12	0.49	0.03	50/60 Hz LXD3J5 ⁽²⁾
24	1.98	0.12	LXD3B7
32	3.76	0.22	LXD3C7
42	6.18	0.37	LXD3D7
48	7.97	0.48	LXD3E7
100	37.63	2.07	LXD3K7
110	42.28	2.50	LXD3F7
115	48.76	2.74	LXD3FE7
120	37.63	2.07	LXD3G7 ⁽⁵⁾
127	60.29	3.34	LXD3FC7
200	149	8.27	LXD3L7
208	105	6.22	LXD3LE7 ⁽⁵⁾
220	182	10	LXD3M7 ⁽³⁾
230	192	10.9	LXD3P7
240	202	11.9	LXD3U7
277	193	11	LXD3W7 ⁽⁵⁾
380	512	29.9	LXD3Q7 ⁽⁴⁾
400	607	33.1	LXD3V7
415	635	35.6	LXD3N7
440	682	40.1	LXD3R7
480	607	33.1	LXD3T7 ⁽⁵⁾
500	878	51.7	LXD3S7
575	1238	68.4	LXD3SC7
600	1304	74.5	LXD3X7
660	1593	90.1	LXD3YC7
690	1683	98.5	LXD3Y7

⁽¹⁾ The last 2 digits in the reference represent the voltage code.⁽²⁾ This coil can only be used on 50 Hz.⁽³⁾ Suitable for use on 230 V / 50 Hz. In this case, apply a coefficient of 0.6 to the mechanical durability of the contactor (see page B8/62 and B8/64).⁽⁴⁾ Suitable for use on 400 V / 50 Hz. In this case, apply a coefficient of 0.6 to the mechanical durability of the contactor (see page B8/62 and B8/64).⁽⁵⁾ This coil can only be used on 60 Hz.

TeSys contactors

a.c. coils for TeSys D, 3 or 4-pole contactors

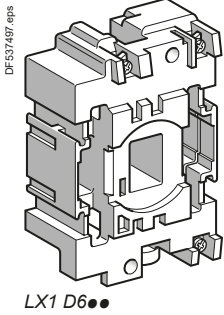

For 3 or 4-pole contactors LC1D40, D50, D65, D80, D95

Specifications

Average consumption at 20 °C:

■ inrush (cos φ = 0.75) 50 Hz: 200 VA, 60 Hz: 220 VA

■ sealed (cos φ = 0.3) 50 Hz: 20 VA, 60 Hz: 22 VA.

Operating range (θ ≤ 55 °C): 0.85...1.1 Uc.

Control circuit voltage Uc	Average resistance at 20 °C ±10 %	Inductance of closed circuit	Reference (1)	Average resistance at 20 °C ±10 %		Inductance of closed circuit	Reference (1)	
				Ω	H			
				50 Hz			60 Hz	
24	1.4	0.09	LX1D6B5	1.05	0.06		LX1D6B6	
32	2.6	0.16	LX1D6C5	–	–		–	
42	4.4	0.27	LX1D6D5	–	–		–	
48	5.5	0.35	LX1D6E5	4.2	0.23		LX1D6E6	
110	31	1.9	LX1D6F5	22	1.2		LX1D6F6	
115	31	1.9	LX1D6FE5	–	–		–	
120	–	–	–	28	1.5		LX1D6G6	
127	41	2.4	LX1D6G5	–	–		–	
208	–	–	–	86	4.3		LX1D6L6	
220	–	–	–	98	4.8		LX1D6M6	
220/230	127	7.5	LX1D6M5	–	–		–	
230	133	8.1	LX1D6P5	–	–		–	
240	152	8.7	LX1D6U5	120	5.7		LX1D6U6	
256	166	10	LX1D6W5	–	–		–	
277	–	–	–	157	8		LX1D6W6	
380	–	–	–	300	14		LX1D6Q6	
380/400	381	22	LX1D6Q5	–	–		–	
400	411	25	LX1D6V5	–	–		–	
415	463	26	LX1D6N5	–	–		–	
440	513	30	LX1D6R5	392	19		LX1D6R6	
480	–	–	–	480	23		LX1D6T6	
500	668	38	LX1D6S5	–	–		–	
575	–	–	–	675	33		LX1D6S6	
600	–	–	–	775	36		LX1D6X6	
660	1220	67	LX1D6Y5	–	–		–	

Specifications

Average consumption at 20 °C:

■ inrush (cos φ = 0.75) 50/60 Hz: 245 VA at 50 Hz

■ sealed (cos φ = 0.3) 50/60 Hz: 26 VA at 50 Hz.

Operating range (θ ≤ 55 °C): 0.85...1.1 Uc.

				50/60 Hz			
24	–	–	–	1.22	0.08		LX1D6B7
42	–	–	–	3.5	0.25		LX1D6D7
48	–	–	–	5	0.32		LX1D6E7
110	–	–	–	26	1.7		LX1D6F7
115	–	–	–	–	–		LX1D6FE7
120	–	–	–	32	2		LX1D6G7
220/230 (2)	–	–	–	102	6.7		LX1D6M7
230	–	–	–	115	7.7		LX1D6P7
230/240 (3)	–	–	–	131	8.3		LX1D6U7
380/400 (4)	–	–	–	310	20		LX1D6Q7
400	–	–	–	349	23		LX1D6V7
415	–	–	–	390	24		LX1D6N7
440	–	–	–	410	27		LX1D6R7

(1) The last 2 digits in the reference represent the voltage code.

(2) For use on 230 V / 50 Hz, apply a coefficient of 0.6 to the mechanical durability of the contactor, see page B8/62 and B8/64. This coil can be used on 240 V at 60 Hz.

(3) This coil can be used on 220/240 V at 50 Hz and on 240 V only at 60 Hz.

(4) For use on 400 V / 50 Hz, apply a coefficient of 0.6 to the mechanical durability of the contactor, see page B8/62 and B8/64.

TeSys contactors

a.c. coils for TeSys D, 3 or 4-pole contactors

DF:537502.eps

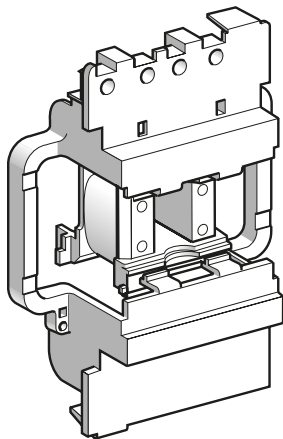

LX1 D8●●

For 3 or 4-pole contactors LC1 D115

Specifications

Average consumption at 20 °C:

■ inrush ($\cos \phi = 0.8$) 50 or 60 Hz: 300 VA■ sealed ($\cos \phi = 0.3$) 50 or 60 Hz: 22 VA.Operating range ($\theta \leq 55$ °C): 0.85... 1.1 Uc.

Control circuit voltage Uc	Average resistance at 20 °C ± 10 %	Inductance of closed circuit	Reference ⁽¹⁾	Average resistance at 20 °C ± 10 %		Reference ⁽¹⁾
				Ω	H	
			50 Hz		60 Hz	
24	1.24	0.09	LX1D8B5	0.87	0.07	LX1D8B6
32	2.14	0.17	LX1D8C5	–	–	–
42	3.91	0.28	LX1D8D5	–	–	–
48	4.51	0.36	LX1D8E5	3.91	0.28	LX1D8E6
110	26.53	2.00	LX1D8F5	19.97	1.45	LX1D8F6
115	26.53	2.00	LX1D8FE5	–	–	–
120	–	–	–	24.02	1.70	LX1D8G6
127	32.75	2.44	LX1D8FC5	–	–	–
208	–	–	–	67.92	5.06	LX1D8L6
220	104.77	7.65	LX1D8M5	79.61	5.69	LX1D8M6
230	104.77	8.29	LX1D8P5	–	–	–
240	125.25	8.89	LX1D8U5	97.04	6.75	LX1D8U6
277	–	–	–	125.75	8.89	LX1D8W6
380	338.51	22.26	LX1D8Q5	243.07	17.04	LX1D8Q6
400	368.43	25.55	LX1D8V5	–	–	–
415	368.43	27.65	LX1D8N5	–	–	–
440	441.56	30.34	LX1D8R5	338.51	22.26	LX1D8R6
480	–	–	–	368.43	25.55	LX1D8T6
500	566.62	38.12	LX1D8S5	–	–	–

For 3 or 4-pole contactors LC1 D115, LC1 D150

Specifications

Average consumption at 20 °C:

■ inrush: $\cos \phi = 0.9$ - 280 to 350 VA■ sealed: $\cos \phi = 0.9$ - 2 to 18 VA.Operating range ($\theta \leq 55$ °C): 0.8... 1.15 Uc.

Coils with integral suppression device fitted as standard, class B.

Control circuit voltage Uc	Average resistance at 20 °C ± 10 %	Inductance of closed circuit	Reference ⁽¹⁾	Average resistance at 20 °C ± 10 %		Reference ⁽¹⁾
				Ω	H	
50/60 Hz						
24	–	–	–	147	3.03	LX1D8B7
32	–	–	–	301	8.28	LX1D8C7
42	–	–	–	498	13.32	LX1D8D7
48	–	–	–	1061	24.19	LX1D8E7
110	–	–	–	4377	109.69	LX1D8F7
115	–	–	–	4377	109.69	LX1D8FE7
120	–	–	–	4377	109.69	LX1D8G7
127	–	–	–	6586	152.65	LX1D8FC7
208	–	–	–	10 895	260.15	LX1D8LE7
220	–	–	–	9895	210.72	LX1D8M7
230	–	–	–	9895	210.72	LX1D8P7
240	–	–	–	9895	210.72	LX1D8U7
277	–	–	–	21 988	533.17	LX1D8UE7
380	–	–	–	21 011	482.42	LX1D8Q7
400	–	–	–	21 011	482.42	LX1D8V7
415	–	–	–	21 011	482.42	LX1D8N7
440	–	–	–	21 501	507.47	LX1D8R7
480	–	–	–	32 249	938.41	LX1D8T7
500	–	–	–	32 249	938.41	LX1D8S7

⁽¹⁾ The last 2 digits in the reference represent the voltage code.

TeSys contactors

d.c. coils for TeSys D, 3 or 4-pole contactors

For 3-pole contactors LC1 D80 or 4-pole contactors LP1 D80

Specifications

Average consumption: 22 W.

Operating range: 0.85...1.1 Uc.

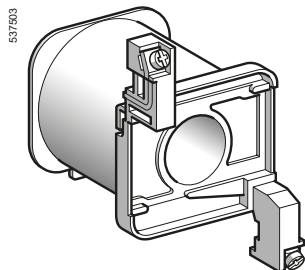

LX4 D7●D

Control circuit voltage Uc	Average resistance at 20 °C ± 10%	Inductance of closed circuit	Reference ⁽¹⁾	Weight
V	Ω	H		kg
12	6.6	0.46	LX4D7JD	0.680
24	27	1.89	LX4D7BD	0.680
36	57	4	LX4D7CD	0.680
48	107	7.5	LX4D7ED	0.680
60	170	11.9	LX4D7ND	0.680
72	230	16.1	LX4D7SD	0.680
110	564	39.5	LX4D7FD	0.680
125	718	50.3	LX4D7GD	0.680
220	2215	155	LX4D7MD	0.680
250	2850	200	LX4D7UD	0.680
440	9195	640	LX4D7RD	0.680

⁽¹⁾ The last 2 digits in the reference represent the voltage code.

TeSys contactors

d.c. coils for TeSys D, 3 or 4-pole contactors

For contactors LC1 D115, D150

Specifications

Consumption: inrush 270 to 365 W, sealed 2.4 to 5.1 W.

Operating range: 0.75...1.2 Uc.

Coils with integral suppression device fitted as standard, class B.

Control circuit voltage Uc	Average resistance at 20 °C ± 10 %	Inductance of closed circuit	Reference ⁽¹⁾	Weight
V	Ω	H		kg
24	147	3.03	LX4D8BD	0.300
48	1061	24.19	LX4D8ED	0.300
60	1673	38.44	LX4D8ND	0.300
72	2500	56.27	LX4D8SD	0.300
110	4377	109.69	LX4D8FD	0.300
125	6586	152.65	LX4D8GD	0.300
220	9895	210.72	LX4D8MD	0.300
250	18 022	345.40	LX4D8UD	0.300
440	21 501	684.66	LX4D8RD	0.300

5379M4

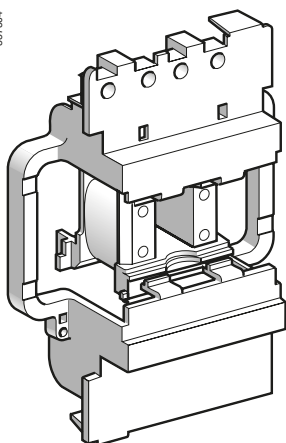

LX4 D8●D

For 3-pole contactors LC1 D80 or 4-pole contactors LP1 D80

Specifications

Wide range coils for specific applications

Average consumption: 23 W.

Operating range: 0.75 to 1.2 Uc.

Coils with "TH" treatment as standard.

Control circuit voltage Uc	Average resistance at 20 °C ± 10 %	Inductance of closed circuit	Reference ⁽¹⁾	Weight
V	Ω	H		kg
12	6.2	0.49	LX4D7JW	0.680
24	23.5	1.75	LX4D7BW	0.680
36	51.9	4.18	LX4D7CW	0.680
48	94.2	7	LX4D7EW	0.680
72	204	15.7	LX4D7SW	0.680
110	483	36	LX4D7FW	0.680
220	1922	144	LX4D7MW	0.680

⁽¹⁾ The last 2 digits in the reference represent the voltage code.