

TeSys contactors

Contactors for motor control, 6 to 16 A in category AC-3 and 6 to 12 A in category AC-4

Control circuit: a.c.

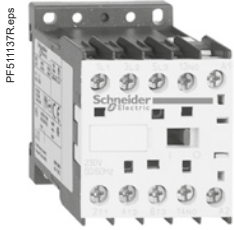

LC1 K0910●●



LC1 K09103●●



LC1 K09107●●

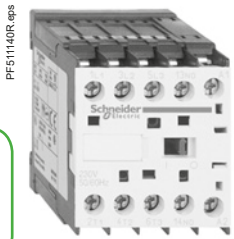

LC1 K09105●●



LC7 K0910●●

Contactors selection according to utilisation category, see pages A6/25 to A6/29 and A6/32 to A6/35. Mounting on 35 mm rail or Ø4 screw fixing. Screws in the open "ready-to-tighten" position. Add-on auxiliary contact blocks and accessories, see pages B8/49 to B8/51.

3-pole contactors for standard applications

Standard power ratings of 3-phase motors 50-60 Hz in category AC-3			Rated operational current in category AC-3 440 V up to	Instantaneous auxiliary contacts	Basic reference, to be completed by adding the voltage code (1)(2)
220 V	380 V	440/500 V			
230 V	415 V	660/690 V			
kW	kW	kW	A		

Screw clamp connections

1.5	2.2	3	6	1	-	LC1K0610●●
				-	1	LC1K0601●●
2.2	4	4	9	1	-	LC1K0910●●
				-	1	LC1K0901●●
3	5.5	4 (> 440)	12	1	-	LC1K1210●●
		5.5 (440)		-	1	LC1K1201●●
4	7.5	4 (> 440)	16	1	-	LC1K1610●●
		5.5 (440)		-	1	LC1K1601●●

Spring terminal connections (3)

For 6 to 12 A ratings only, in the references selected above, insert a figure 3 before the voltage code. Example: LC1 K0610●● becomes LC1 K06103●●.

Faston connectors, 1 x 6.35 or 2 x 2.8

For 6 to 16 A ratings, in the references selected above, insert a figure 7 before the voltage code. Example: LC1 K0610●● becomes LC1 K06107●●.

Solder pins for printed circuit boards

For 6 to 16 A ratings, in the references selected above, insert a figure 5 before the voltage code. Example: LC1 K0610●● becomes LC1 K06105●●.

3-pole silent contactors

Recommended for use in areas sensitive to noise, high interference mains supplies, etc. Coil with rectifier incorporated, suppressor fitted as standard.

Screw clamp connections

1.5	2.2	3	6	1	-	LC7K0610●●
				-	1	LC7K0601●●
2.2	4	4	9	1	-	LC7K0910●●
				-	1	LC7K0901●●
3	5.5	4 (> 440)	12	1	-	LC7K1210●●
		5.5 (440)		-	1	LC7K1201●●

Faston connectors, 1 x 6.35 or 2 x 2.8

In the references selected above, insert a figure 7 before the voltage code. Example: LC7 K0610●● becomes LC7 K06107●●.

Solder pins for printed circuit boards

In the references selected above, insert a figure 5 before the voltage code. Example: LC7 K0610●● becomes LC7 K06105●●.

(1) Standard control circuit voltages (for other voltages, please consult your Regional Sales Office):

a.c. supply (4)

Contactors LC1 K (0.8...1.15 Uc) (0.85...1.1 Uc)

Volts	12	20	24 (2)	36	42	48	110	115	120	127	200/208	220/230	230	230/240
50 Hz (5)			B5		D5	E5							P5	
50/60 Hz	J7	Z7	B7	C7	D7	E7	F7	FE7	G7	FC7	L7	M7	P7	U7
Volts	256	277	380/400	400	400/415	440	480	500	575	600	660/690			
50/60 Hz	W7	UE7	Q7	-	V7	N7	R7	T7	S7	SC7	X7	Y7	-	-

Up to and including 240 V, coil with integral suppression device available: add 2 to the code required. Example: J72.

Contactors LC7 K (0.85...1.1 Uc)

Volts	24	42	48	110	115	220	230/240
50/60 Hz	B7	D7	E7	F7	FE7	M7	U7

(2) For mains supplies with a high level of interference (voltage surge > 800 V), use a suppressor module LA4 KE1FC (50...129 V) or LA4 KE1UG (130...250 V), see page B8/50.

(3) For LC●K●●●●3 / LP●K●●●●3 with spring terminal, Ith max = 10 A.

(4) (0.8...1.15 Uc) for single voltage coil; (0.85...1.1 Uc) for dual voltage coil, exemple 200/208 V AC.

(5) Only available for 'screw clamp terminals' versions.

TeSys contactors

Contactors for motor control, 6 to 12 A in categories AC-3 and AC-4

Control circuit: d.c. or low consumption

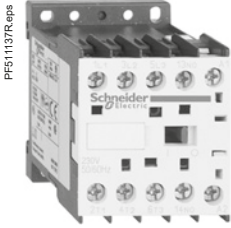

LP1 K0910●●

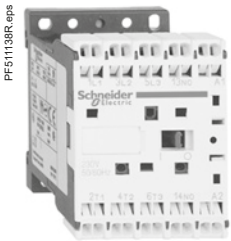

LP1 K09103●●

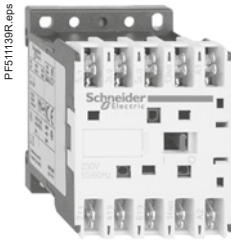

LP1 K09107●●



LP1 K09105●●

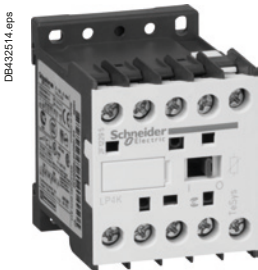

LP4 K0910●●

Contactor selection according to utilisation category, see pages A6/25 to A6/29 and A6/32 to A6/35.

Mounting on 35 mm rail or Ø4 screw fixing.

Screws in the open "ready-to-tighten" position.

Add-on auxiliary contact blocks and accessories, see pages B8/49 to B8/51.

3-pole contactors, d.c. supply

Standard power ratings of 3-phase motors 50-60 Hz in category AC-3			Rated operational current in category AC-3 440 V up to	Instantaneous auxiliary contacts 	Basic reference, to be completed by adding the voltage code (1) (2)
220 V	380 V	440/500 V			
230 V	415 V	660/690 V			
kW	kW	kW	A		
Screw clamp connections					
1.5	2.2	3	6	1 -	LP1K0610●●
				- 1	LP1K0601●●
2.2	4	4	9	1 -	LP1K0910●●
				- 1	LP1K0901●●
3	5.5	4 (> 440)	12	1 -	LP1K1210●●
		5.5 (440)		- 1	LP1K1201●●

Spring terminal connections (3)

In the references selected above, insert a figure 3 before the voltage code.

Example: LP1 K0610●● becomes LP1 K06103●●.

Faston connectors, 1 x 6.35 or 2 x 2.8

In the references selected above, insert a figure 7 before the voltage code.

Example: LP1 K0610●● becomes LP1 K06107●●.

Solder pins for printed circuit boards

In the references selected above, insert a figure 5 before the voltage code.

Example: LP1 K0610●● becomes LP1 K06105●●.

3-pole low consumption contactors

Compatible with programmable controller outputs.

Wide range coil (0.7...1.30 Uc), suppressor fitted as standard, consumption 1.8 W.

Screw clamp connections

1.5	2.2	3	6	1 -	LP4K0610●●
				- 1	LP4K0601●●
2.2	4	4	9	1 -	LP4K0910●●
				- 1	LP4K0901●●
3	5.5	4 (> 440)	12	1 -	LP4K1210●●
		5.5 (440)		- 1	LP4K1201●●

Spring terminal connections

In the references selected above, insert a figure 3 before the voltage code.

Example: LP4 K0610●● becomes LP4 K06103●●.

Faston connectors, 1 x 6.35 or 2 x 2.8

In the references selected above, insert a figure 7 before the voltage code.

Example: LP4 K0610●● becomes LP4 K06107●●.

Solder pins for printed circuit boards

In the references selected above, insert a figure 5 before the voltage code.

Example: LP4 K0610●● becomes LP4 K06105●●.

(1) Standard control circuit voltages (for other voltages, please consult your Regional Sales Office):

d.c. supply (contactors LP1 K: 0.8...1.15 Uc)

Volts	12	20	24 (2)	36	48	60	72	100	110	125	155	174	200	220	230	240	250
Code	JD	ZD	BD	CD	ED	ND	SD	KD	FD	GD	PD	QD	LD	MD	MPD	MUD	UD

Coil with integral suppression device available: add 3 to the code required. Example: JD3

Low consumption (contactors LP4 K: 0.7...1.3 Uc)

Volts	12	20	24	48	72	110	120
Code	JW3	ZW3	BW3	EW3	SW3	FW3	GW3

Coil with integral suppression device fitted as standard, by bi-directional peak limiting diode.

(2) For LP1 K only, when connecting an electronic sensor or timer in series with the contactor coil, select a 20 V coil (~ control circuit voltage code Z7, ≡ control circuit voltage code ZD) so as to compensate for the incurred voltage drop.

(3) For LC●K●●●●3 / LP●K●●●●3 with spring terminal, I_{th} max = 10 A.

TeSys contactors

Contactors for control in category AC-1, 20 A

Control circuit: a.c.

Contactor selection according to utilisation category, see pages A6/30 and A6/31.

Mounting on 35 mm rail or Ø4 screw fixing.

Screws in the open "ready-to-tighten" position.

Add-on auxiliary contact blocks and accessories, see pages B8/49 to B8/51.

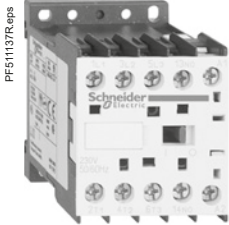

LC1 K09004

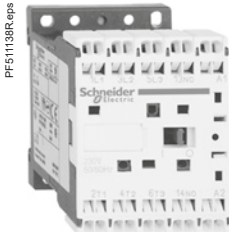

LC1 K09103

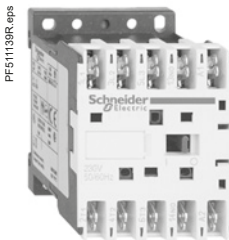

LC1 K09107

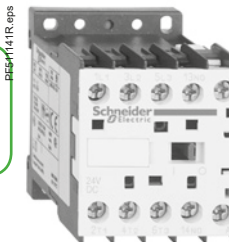

LC1 K09004

Contactors

3 or 4-pole contactors for standard applications ⁽¹⁾

Non-inductive loads Category AC-1 Maximum current at $\theta \leq 50^\circ\text{C}$	Number of poles	Instantaneous auxiliary contacts	Basic reference, to be completed by adding the voltage code ^{(2) (3)}

A

Screw clamp connections

20	3	-	1	-	LC1K0910
					or LC1K1210
	3	-	-	1	LC1K0901
					or LC1K1201
	4	-	-	-	LC1K09004
					or LC1K12004
	2	2	-	-	LC1K09008

Spring terminal connections ⁽⁴⁾

In the references selected above, insert a figure 3 before the voltage code.

Example: LC1 K0910 becomes LC1 K09103.

Faston connectors, 1 x 6.35 or 2 x 2.8

In the references selected above, insert a figure 7 before the voltage code.

Example: LC1 K0910 becomes LC1 K09107.

Solder pins for printed circuit boards

In the references selected above, insert a figure 5 before the voltage code.

Example: LC1 K0910 becomes LC1 K09105.

3 or 4-pole silent contactors ⁽¹⁾

Recommended for use in areas sensitive to noise, high interference mains supplies, etc.

Coil with rectifier incorporated, suppressor fitted as standard.

Screw clamp connections

20	3	-	1	-	LC7K0910
					or LC7K1210
	3	-	-	1	LC7K0901
					or LC7K1201
	4	-	-	-	LC7K09004
					or LC7K12004
	2	2	-	-	LC7K09008

Faston connectors, 1 x 6.35 or 2 x 2.8

In the references selected above, insert a figure 7 before the voltage code.

Example: LC7 K0910 becomes LC7 K09107.

Solder pins for printed circuit boards

In the references selected above, insert a figure 5 before the voltage code.

Example: LC7 K0910 becomes LC7 K09105.

⁽¹⁾ Selection between 9 and 12 A ratings according to number of operating cycles, see AC-1 curve on page A6/30.

⁽²⁾ Standard control circuit voltages (for other voltages, please consult your Regional Sales Office):

a.c. supply ⁽⁵⁾

Contactors LC1 K (0.8...1.15 Uc) (0.85...1.1 Uc)

Volts	12	20	24 ⁽³⁾	36	42	48	110	115	120	127	200/208	220/230	230	230/240
50 Hz ⁽⁶⁾			B5		D5	E5							P5	
50/60 Hz	J7	Z7	B7	C7	D7	E7	F7	FE7	G7	FC7	L7	M7	P7	U7
Volts	256	277	380/400		400	400/415	440	480	500	575	600	660/690		
50/60 Hz	W7	UE7	Q7		V7	N7	R7	T7	S7	SC7	X7	Y7		

Up to and including 240 V, coil with integral suppression device available: add 2 to the code required. Example: J72.

Contactors LC7 K (0.8...1.1 Uc)

Volts	24	42	48	110	115	220	230/240
50/60 Hz	B7	D7	E7	F7	FE7	M7	U7

⁽³⁾ For mains supplies with a high level of interference (voltage surge > 800 V), use a suppressor module LA4 KE1FC (50...129 V) or LA4 KE1UG (130...250 V), see page B8/50.

⁽⁴⁾ For LC●K●●●●3 / LP●K●●●●3 with spring terminal, lth max = 10 A.

⁽⁵⁾ (0.8...1.15 Uc) for single voltage coil; (0.85...1.1 Uc) for dual voltage coil, exemple 200/208 V AC.

⁽⁶⁾ Only available for 'screw clamp terminals' versions.

TeSys contactors

Contactors for control in category AC-1, 20 A

Control circuit: d.c. or low consumption

Contactor selection according to utilisation category, see pages A6/30 and A6/31.

Mounting on 35 mm rail or Ø4 screw fixing.

Screws in the open "ready-to-tighten" position.

Add-on auxiliary contact blocks and accessories, see pages B8/49 to B8/51.

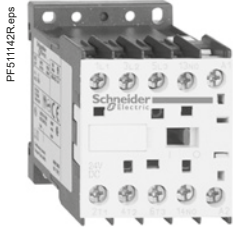

LC1 K09004●●



LC1 K09103●●

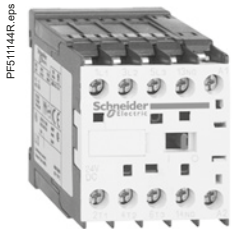

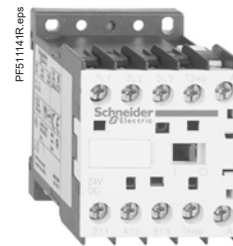

LC1 K09105●●



LC1 K09004●●

3 and 4-pole contactors, d.c. supply ⁽¹⁾

Non-inductive loads Category AC-1 Maximum current at $\theta \leq 50^\circ\text{C}$	Number of poles 	Instantaneous auxiliary contacts 	Basic reference, to be completed by adding the voltage code ⁽²⁾⁽³⁾
--	---	--	---

A

Screw clamp connections

20	3	-	1	-	LP1K0910●● or LP1K1210●●
	3	-	-	1	LP1K0901●● or LP1K1201●●
	4	-	-	-	LP1K09004●● or LP1K12004●●
	2	2	-	-	LP1K09008●●

Spring terminal connections ⁽⁴⁾

In the references selected above, insert a figure 3 before the voltage code.

Example: LP1 K0910●● becomes LP1 K09103●●.

Faston connectors, 1 x 6.35 or 2 x 2.8

In the references selected above, insert a figure 7 before the voltage code.

Example: LP1 K0910●● becomes LP1 K09107●●.

Solder pins for printed circuit boards

In the references selected above, insert a figure 5 before the voltage code.

Example: LP1 K0910●● becomes LP1 K09105●●.

3 or 4-pole low consumption contactors ⁽¹⁾

Compatible with programmable controller outputs.

Wide range coil (0.7...1.30 Uc), suppressor fitted as standard, consumption 1.8 W.

Screw clamp connections

20	3	-	1	-	LP4K0910●●● or LP4K1210●●●
	3	-	-	1	LP4K0901●●● or LP4K1201●●●
	4	-	-	-	LP4K09004●●● or LP4K12004●●●
	2	2	-	-	LP4K09008●●●

Spring terminal connections

In the references selected above, insert a figure 3 before the voltage code.

Example: LP4 K0910●● becomes LP4 K09103●●.

Faston connectors, 1 x 6.35 or 2 x 2.8

In the references selected above, insert a figure 7 before the voltage code.

Example: LP4 K0910●● becomes LP4 K09107●●.

Solder pins for printed circuit boards

In the references selected above, insert a figure 5 before the voltage code.

Example: LP4 K0910●● becomes LP4 K09105●●.

⁽¹⁾ Selection between 9 and 12 A ratings according to number of operating cycles, see AC-1 curve on page A6/30.

⁽²⁾ Standard control circuit voltages (for other voltages, please consult your Regional Sales Office):

d.c. supply (contactors LP1 K: 0.8...1.15 Uc)

Volts ∴	12	20	24 ⁽³⁾	36	48	60	72	100	110	125	155	174	200	220	230	240	250
Code	JD	ZD	BD	CD	ED	ND	SD	KD	FD	GD	PD	QD	LD	MD	MPD	MUD	UD

Coil with integral suppression device available: add 3 to the code required. Example: JD3.

Low consumption (contactors LP4 K: 0.7...1.3 Uc)

Volts ∴	12	20	24	48	72	110	120
Code	JW3	ZW3	BW3	EW3	SW3	FW3	GW3

Coil with integral suppression device fitted as standard, by bi-directional peak limiting diode.

⁽³⁾ For LP1 K only, when connecting an electronic sensor or timer in series with the contactor coil, select a 20 V coil (∴ control circuit voltage code Z7, ∴ control circuit voltage code ZD) so as to compensate for the incurred voltage drop.

⁽⁴⁾ For LC●K●●●●3 / LP●K●●●●3 with spring terminal, I_{th} max = 10 A.

Contactors

TeSys contactors

Reversing contactors for motor control, 6 to 16 A in category AC-3 and 6 to 12 A in category AC-4

Control circuit: a.c.

Reversing contactor selection according to utilisation category, see pages A6/25 to A6/29 and A6/32 to A6/35. Integral mechanical interlock.

It is essential to link the contacts of the electrical interlock.

Pre-wired power circuit connections as standard on screw clamp versions.

Mounting on 35 mm rail or Ø4 screw fixing. Screws in the open "ready-to-tighten" position.

Add-on auxiliary contact blocks and accessories, see pages B8/49 to B8/51.

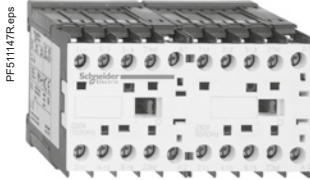

LC2 K0910●●

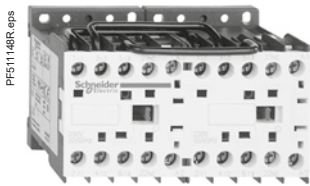

LC2 K09105●●

3-pole reversing contactors for standard applications

Standard power ratings of 3-phase motors 50/60 Hz in category AC-3			Rated operational current in category AC-3 440 V up to	Instantaneous auxiliary contacts per contactor	Basic reference, to be completed by adding the voltage code ⁽¹⁾⁽²⁾
220 V	380 V	440/500 V			
230 V	415 V	660/690 V			

kW	kW	kW	A		
1.5	2.2	3	6	1 -	LC2K0610●●
				- 1	LC2K0601●●
2.2	4	4	9	1 -	LC2K0910●●
				- 1	LC2K0901●●
3	5.5	4 (> 440)	12	1 -	LC2K1210●●
		5.5 (440)		- 1	LC2K1201●●
4	7.5	4 (> 440)	16	1 -	LC2K1610●●
		5.5 (440)		- 1	LC2K1601●●

Spring terminal connections ⁽³⁾

For 6 to 12 A ratings only, in the references selected above, insert a figure 3 before the voltage code. Example: LC2 K0610●● becomes LC2 K06103●●.

Faston connectors, 1 x 6.35 or 2 x 2.8

For 6 to 16 A ratings, in the references selected above, insert a figure 7 before the voltage code. Example: LC2 K0610●● becomes LC2 K06107●●.

Solder pins for printed circuit boards

For 6 to 16 A ratings, in the references selected above, insert a figure 5 before the voltage code. Example: LC2 K0610●● becomes LC2 K06105●●.

3-pole silent reversing contactors

Recommended for use in areas sensitive to noise, high interference mains supplies, etc. Coil with rectifier incorporated, suppressor fitted as standard.

Screw clamp connections

1.5	2.2	3	6	1 -	LC8K0610●●
				- 1	LC8K0601●●
2.2	4	4	9	1 -	LC8K0910●●
				- 1	LC8K0901●●
3	5.5	4 (> 440)	12	1 -	LC8K1210●●
		5.5 (440)		- 1	LC8K1201●●

Faston connectors, 1 x 6.35 or 2 x 2.8

In the references selected above, insert a figure 7 before the voltage code. Example: LC8 K0610●● becomes LC8 K06107●●.

Solder pins for printed circuit boards

In the references selected above, insert a figure 5 before the voltage code. Example: LC8 K0610●● becomes LC8 K06105●●.

⁽¹⁾ Standard control circuit voltages (for other voltages, please consult your Regional Sales Office):

a.c. supply ⁽⁴⁾

Reversing contactors LC2 K (0.8...1.15 Uc) (0.85...1.1 Uc)

Volts	12	20	24 ⁽²⁾	36	42	48	110	115	120	127	200/208	220/230	230	230/240
50/60 Hz	J7	Z7	B7	C7	D7	E7	F7	FE7	G7	FC7	L7	M7	P7	U7
Volts	256	277	380/400	400	400/415	440	480	500	575	600	660/690			
50/60 Hz	W7	UE7	Q7	V7	N7	R7	T7	S7	SC7	X7	Y7			

Up to and including 240 V, coil with integral suppression device available: add 2 to the code required. Example: J72.

Reversing contactors LC8 K (0.8...1.1 Uc)

Volts	24	42	48	110	115	220	230/240
50/60 Hz	B7	D7	E7	F7	FE7	M7	U7

⁽²⁾ For mains supplies with a high level of interference (voltage surge > 800 V), use a suppressor module LA4 KE1FC (50...129 V) or LA4 KE1UG (130...250 V), see page B8/50.

⁽³⁾ For LC●K●●●●3 / LP●K●●●●3 with spring terminal, lth max = 10 A.

⁽⁴⁾ (0.8...1.15 Uc) for single voltage coil; (0.85...1.1 Uc) for dual voltage coil, exemple 200/208 V AC.

TeSys contactors

Reversing contactors for motor control, 6 to 12 A in categories AC-3 and AC-4

Control circuit: d.c. or low consumption

Reversing contactor selection according to utilisation category, see pages A6/25 to A6/29 and A6/32 to A6/35. Integral mechanical interlock.

It is essential to link the contacts of the electrical interlock.

Pre-wired power circuit connections as standard on screw clamp versions.

Mounting on 35 mm rail or Ø4 screw fixing.

Screws in the open "ready-to-tighten" position.

Add-on auxiliary contact blocks and accessories, see pages B8/49 to B8/51.

3-pole reversing contactors, d.c. supply

Standard power ratings of 3-phase motors 50-60 Hz in category AC-3				Rated operational current in category AC-3 440 V up to	Instantaneous auxiliary contacts per contactor	Basic reference, to be completed by adding the voltage code ⁽¹⁾⁽²⁾
220 V	380 V	440/500 V				
230 V	415 V	660/690 V				
kW	kW	kW	A			
Screw clamp connections						
1.5	2.2	3	6	1	–	LP2K0610●●
				–	1	LP2K0601●●
2.2	4	4	9	1	–	LP2K0910●●
				–	1	LP2K0901●●
3	5.5	4 (> 440)	12	1	–	LP2K1210●●
		5.5 (440)		–	1	LP2K1201●●

Spring terminal connections ⁽³⁾

In the references selected above, insert a figure 3 before the voltage code.

Example: LP2 K0610●● becomes LP2 K06103●●.

Faston connectors, 1 x 6.35 or 2 x 2.8

In the references selected above, insert a figure 7 before the voltage code.

Example: LC2 K0610●● becomes LC2 K06107●●.

Solder pins for printed circuit boards

For 6 to 16 A ratings, in the references selected above, insert a figure 5 before the voltage code.

Example: LC2 K0610●● becomes LC2 K06105●●.

3-pole low consumption reversing contactors

Compatible with programmable controller outputs.

Wide range coil (0.7...1.30 Uc), suppressor fitted as standard, consumption 1.8 W.

Screw clamp connections

1.5	2.2	3	6	1	–	LP5K0610●●
				–	1	LP5K0601●●
2.2	4	4	9	1	–	LP5K0910●●
				–	1	LP5K0901●●
3	5.5	4 (> 440)	12	1	–	LP5K1210●●
		5.5 (440)		–	1	LP5K1201●●

Spring terminal connections

In the references selected above, insert a figure 3 before the voltage code.

Example: LP5 K0610●● becomes LP5 K06103●●.

Faston connectors, 1 x 6.35 or 2 x 2.8

In the references selected above, insert a figure 7 before the voltage code.

Example: LP5 K0610●● becomes LP5 K06107●●.

Solder pins for printed circuit boards

In the references selected above, insert a figure 5 before the voltage code.

Example: LP5 K0610●● becomes LP5 K06105●●.

⁽¹⁾ Standard control circuit voltages (for other voltages, please consult your Regional Sales Office):

d.c. supply

Reversing contactors LP2 K (0.8...1.15 Uc)

Volts	12	20	24 ⁽²⁾	36	48	60	72	100	110	125	155	174	200	220	230	240	250
Code	JD	ZD	BD	CD	ED	ND	SD	KD	FD	GD	PD	QD	LD	MD	MPD	MUD	UD

Coil with integral suppression device available: add 3 to the code required. Example: JD3.

Low consumption

Reversing contactors LP5 K (0.7...1.3 Uc)

Volts	12	20	24	48	72	110	120
Code	JW3	ZW3	BW3	EW3	SW3	FW3	GW3

Coil with integral suppression device fitted as standard, by bi-directional peak limiting diode.

⁽²⁾ For LP2 K only, when connecting an electronic sensor or timer in series with the contactor coil, select a 20 V coil (~ control circuit voltage code Z7, --- control circuit voltage code ZD) so as to compensate for the incurred voltage drop.

⁽³⁾ For LC●K●●●●3 / LP●K●●●●3 with spring terminal, I_{th} max = 10 A.

TeSys contactors

Reversing contactors for control in category AC-1, 20 A

Control circuit: a.c.

Warning: reversing contactors LC2 K0910●● and LC2 K0901●● are pre-wired for reverse motor operation as standard.

Reversing contactor selection according to utilisation category, see pages A6/30 and A6/31.

Integral mechanical interlock.

It is essential to link the contacts of the electrical interlock.

Mounting on 35 mm rail or Ø4 screw fixing.

Screws in the open "ready-to-tighten" position.

Add-on auxiliary contact blocks and accessories, see pages B8/49 to B8/51.

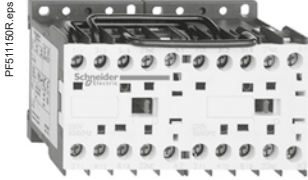

LC2 K0910●●

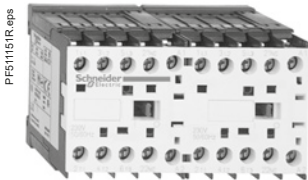

LC2 K09105●●

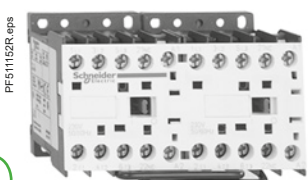

LC2 K09004●●

3 or 4-pole reversing contactors for standard applications ⁽¹⁾

Non-inductive loads Category AC-1 Maximum current at θ ≤ 50 °C	Number of poles	Instantaneous auxiliary contacts per contactor	Basic reference, to be completed by adding the voltage code ^{(2) (3)}

Spring terminal connections ⁽⁴⁾

In the references selected above, insert a figure 3 before the voltage code.

Example: LC2 K0910●● becomes LC2 K09103●●.

Faston connectors, 1 x 6.35 or 2 x 2.8

In the references selected above, insert a figure 7 before the voltage code.

Example: LC2 K0910●● becomes LC2 K09107●●.

Solder pins for printed circuit boards

In the references selected above, insert a figure 5 before the voltage code.

Example: LC2 K0910●● becomes LC2 K09105●●.

3 or 4-pole silent reversing contactors ⁽¹⁾

Recommended for use in areas sensitive to noise, high interference mains supplies, etc.

Coil with rectifier incorporated, suppressor fitted as standard.

Screw clamp connections

20	3	-	1	-	LC8K0910●●
					or LC8K1210●●
	3	-	-	1	LC8K0901●●
					or LC8K1201●●
	4	-	-	-	LC8K09004●●
					or LC8K12004●●

Faston connectors, 1 x 6.35 or 2 x 2.8

In the references selected above, insert a figure 7 before the voltage code.

Example: LC8 K0910●● becomes LC8 K09107●●.

Solder pins for printed circuit boards

In the references selected above, insert a figure 5 before the voltage code.

Example: LC8 K0910●● becomes LC8 K09105●●.

⁽¹⁾ Selection between 9 and 12 A ratings according to number of operating cycles, see AC-1 curve on page A6/30.

⁽²⁾ Standard control circuit voltages (for other voltages, please consult your Regional Sales Office):

a.c. supply ⁽⁵⁾

Reversing contactors LC2 K (0.8...1.15 Uc) (0.85...1.1 Uc)

Volts	12	20	24 ⁽³⁾	36	42	48	110	115	120	127	200/208	220/230	230	230/240
50/60 Hz	J7	Z7	B7	C7	D7	E7	F7	FE7	G7	FC7	L7	M7	P7	U7
Volts	256	277	380/400	400	400/415	440	480	500	575	600	660/690			
50/60 Hz	W7	UE7	Q7		V7	N7	R7	T7	S7	SC7	X7	Y7		

Up to and including 240 V, coil with integral suppression device available: add 2 to the code required. Example: J72.

Reversing contactors LC8 K (0.8...1.1 Uc)

Volts	24	42	48	110	115	220	230/240
50/60 Hz	B7	D7	E7	F7	FE7	M7	U7

⁽³⁾ For mains supplies with a high level of interference (voltage surge > 800 V), use a suppressor module LA4 KE1FC (50...129 V) or LA4 KE1UG (130...250 V), see page B8/50.

⁽⁴⁾ For LC●K●●●●3 / LP●K●●●●3 with spring terminal, Ith max = 10 A.

⁽⁵⁾ (0.8...1.15 Uc) for single voltage coil; (0.85...1.1 Uc) for dual voltage coil, exemple 200/208 V AC.

TeSys contactors

Reversing contactors for control in category AC-1, 20 A

Control circuit: d.c. or low consumption

Warning: reversing contactors LP2 K0910●● and LP2 K0901●● are pre-wired for reverse motor operation as standard.

Reversing contactor selection according to utilisation category, see pages A6/30 and A6/31.

Integral mechanical interlock.



It is essential to link the contacts of the electrical interlock.

Mounting on 35 mm rail or Ø4 screw fixing.

Screws in the open "ready-to-tighten" position.

Add-on auxiliary contact blocks and accessories, see pages B8/49 to B8/51.

3 or 4-pole reversing contactors, d.c. supply ⁽¹⁾

Non-inductive loads Category AC-1 Maximum current at $\theta \leq 50^\circ\text{C}$	Number of poles	Instantaneous auxiliary contacts per contactor	Basic reference, to be completed by adding the voltage code ^{(2) (3)}		
					
A					
Screw clamp connections					
20	3	-	1	-	LP2K0910●● or LP2K1210●●
	3	-	-	1	LP2K0901●● or LP2K1201●●
	4	-	-	-	LP2K09004●● or LP2K12004●●

Spring terminal connections ⁽⁴⁾

In the references selected above, insert a figure 3 before the voltage code.

Example: LP2 K0910●● becomes LP2 K09103●●.

Faston connectors, 1 x 6.35 or 2 x 2.8

In the references selected above, insert a figure 7 before the voltage code.

Example: LP2 K0910●● becomes LP2 K09107●●.

Solder pins for printed circuit boards

In the references selected above, insert a figure 5 before the voltage code.

Example: LP2 K0910●● becomes LP2 K09105●●.

3 or 4-pole low consumption reversing contactors ⁽¹⁾

Compatible with programmable controller outputs.

Wide range coil (0.7...1.30 U_c), suppressor fitted as standard, consumption 1.8 W.

Screw clamp connections

20	3	-	1	-	LP5K0910●●●● or LP5K1210●●●●
	3	-	-	1	LP5K0901●●●● or LP5K1201●●●●
	4	-	-	-	LP5K09004●●●● or LP5K12004●●●●

Spring terminal connections

In the references selected above, insert a figure 3 before the voltage code.

Example: LP5 K0910●● becomes LP5 K09103●●.

Faston connectors, 1 x 6.35 or 2 x 2.8

In the references selected above, insert a figure 7 before the voltage code.

Example: LP5 K0910●● becomes LP5 K09107●●.

Solder pins for printed circuit boards

In the references selected above, insert a figure 5 before the voltage code.

Example: LP5 K0910●● becomes LP5 K09105●●.

⁽¹⁾ Selection between 9 and 12 A ratings according to number of operating cycles, see AC-1 curve on page A6/30.

⁽²⁾ Standard control circuit voltages (for other voltages, please consult your Regional Sales Office):

d.c. supply (reversing contactors LP2 K: 0.8...1.15 U_c)

Volts ---	12	20	24 ⁽³⁾	36	48	60	72	100	110	125	155	174	200	220	230	240	250
Code	JD	ZD	BD	CD	ED	ND	SD	KD	FD	GD	PD	QD	LD	MD	MPD	MUD	UD

Coil with integral suppression device available: add 3 to the code required. Example: JD3.

Low consumption (reversing contactors LP5 K: 0.7...1.3 U_c)

Volts ---	12	20	24	48	72	110	120
Code	JW3	ZW3	BW3	EW3	SW3	FW3	GW3

Coil with integral suppression device fitted as standard, by bi-directional peak limiting diode.

⁽³⁾ For LP2 K only, when connecting an electronic sensor or timer in series with the contactor coil, select a 20 V coil (~ control circuit voltage code Z7, --- control circuit voltage code ZD) so as to compensate for the incurred voltage drop.

⁽⁴⁾ For LC●K●●●●3 / LP●K●●●●3 with spring terminal, I_{th} max = 10 A.

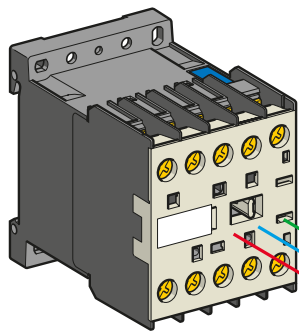

LC1, LC7, LP1 K

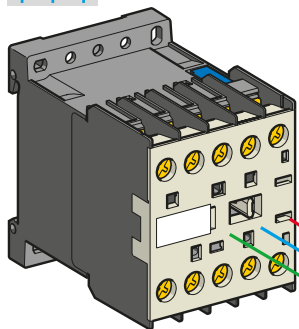

LC1, LC7, LP1 K

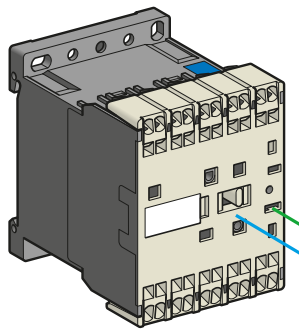

LC1, LP1 K

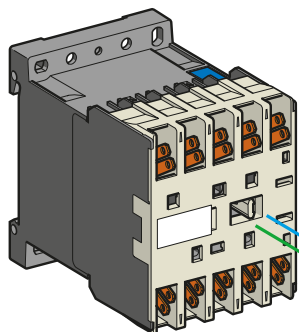

LC1, LC7, LP1 K



Contactor

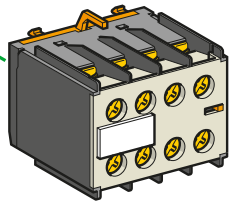

LA1 KN...M

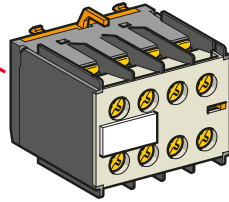

LA1 KN.../

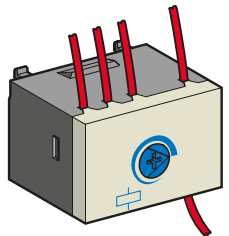

LA2 KT2.../

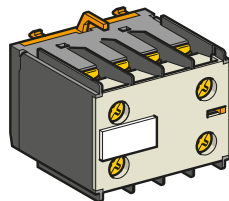

LA1 KN...P/

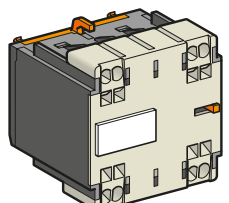

LA1 KN...3/

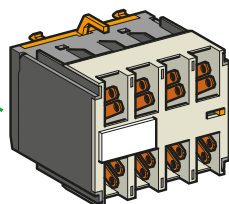

LA1 KN...7/

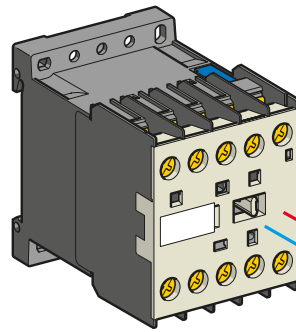

LP4

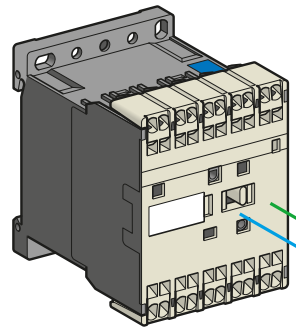

LP4

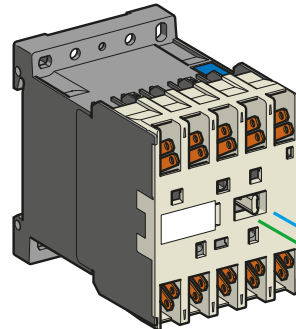

LP4

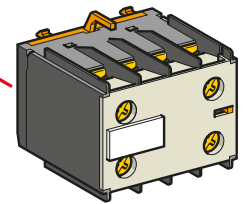

LA1 KN.../

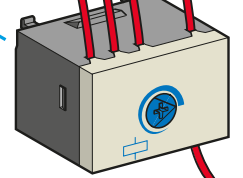

LA2 KT2.../

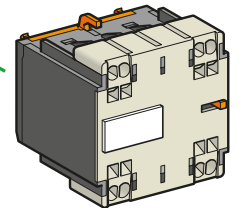

LA1 KN...3/

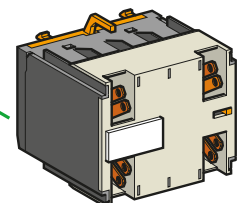

LA1 KN...7/



TeSys contactors

TeSys K contactors and reversing contactors

Auxiliary contact blocks

Instantaneous auxiliary contact blocks

Recommended for standard applications. Clip-on front mounting, 1 block per contactor

Connection	For use on contactors	Composition		Reference		
						
Screw clamp terminals	All products with screw clamp terminals	2	–	LA1KN20		
		–	2	LA1KN02		
		1	1	LA1KN11		
	All products with screw clamp terminals except low consumption	4	–	LA1KN40		
		3	1	LA1KN31		
		2	2	LA1KN22		
		1	3	LA1KN13		
–	4	LA1KN04				
Spring terminals	All products with spring terminals	2	–	LA1KN203		
		–	2	LA1KN023		
		1	1	LA1KN113		
	All products with spring terminals except low consumption	4	–	LA1KN403		
		3	1	LA1KN313		
		2	2	LA1KN223		
		1	3	LA1KN133		
		–	4	LA1KN043		
		Faston connectors, 1 x 6.35 or 2 x 2.8	All products with Faston connectors	2	–	LA1KN207
				–	2	LA1KN027
1	1			LA1KN117		
All products with Faston connectors except low consumption	4		–	LA1KN407		
	3		1	LA1KN317		
	2		2	LA1KN227		
	1		3	LA1KN137		
	–		4	LA1KN047		

With terminal referencing to standard EN 50012. Clip-on front mounting, 1 block per contactor

Screw clamp terminals with referencing conforming to standard EN 50012	All 3-pole + N/O products with screw clamp terminals except LP4 and LP5 K12	–	2	LA1KN02M
		1	1	LA1KN11M
	All 3-pole + N/O products with screw clamp terminals except LP4 or LP5 K06, K09 and K12	3	1	LA1KN31M
		2	2	LA1KN22M
		1	3	LA1KN13M
	All 4-pole products with screw clamp terminals except LP4 or LP5 K12	1	1	LA1KN11P
2		2	LA1KN22P	

Electronic time delay auxiliary contact blocks

Relay output with common point changeover contact, \sim or \equiv 240 V, 2 A maximum.

Control voltage 0.85...1.1 Uc.

Maximum switching capacity 250 VA or 150 W.

Operating temperature -10...+60 °C.

Reset time: 1.5 s during the time delay period, 0.5 s after the time delay period.

Clip-on front mounting, 1 block per contactor

Voltage	Type	Timing range	Composition	Reference
\sim or \equiv	On-delay	1...30		
24...48	On-delay	1...30	1	LA2KT2E
\sim 110...240	On-delay	1...30	1	LA2KT2U

References - TeSys K

TeSys contactors

TeSys K contactors and reversing contactors

Suppressor modules incorporating LED indicator

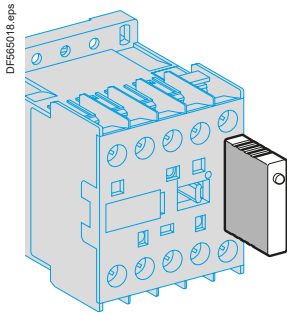

LA4 K●●●

References

Mounting and connection	Type	For voltages	Sold in lots of	Unit reference
Clip-on fixing on the front of contactors LC1 and LP1, with locating device. No tools required.	Varistor ⁽¹⁾	~ and ≍ 12...24 V	5	LA4KE1B
		~ and ≍ 32...48 V	5	LA4KE1E
		~ and ≍ 50...129 V	5	LA4KE1FC
		~ and ≍ 130...250 V	5	LA4KE1UG
Diode + Zener diode ⁽²⁾		≍ 12...24 V	5	LA4KC1B
		≍ 32...48 V	5	LA4KC1E
	RC ⁽³⁾	~ 110...250 V	5	LA4KA1U

(1) Protection provided by limiting the transient voltage to 2 Uc max. Maximum reduction of transient voltage peaks. Slight increase in drop-out time (1.1 to 1.5 times the normal time).

(2) No overvoltage or oscillating frequency.

Polarised component.

Slight increase in drop-out time (1.1 to 1.5 times the normal time).

(3) Protection by limiting the transient voltage to 3 Uc max. and limitation of the oscillating frequency.

Slight increase in drop-out time (1.2 to 2 times the normal time).

TeSys contactors

TeSys K contactors and reversing contactors

Accessories

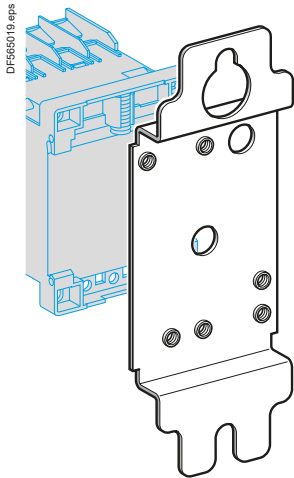

DX1 AP25

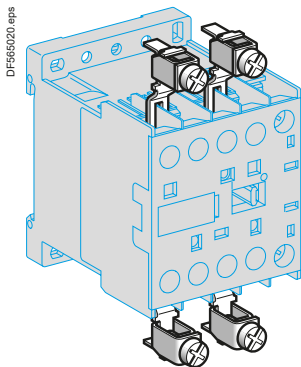

LA9 E01

Mounting and marking accessories

Description	Application		Sold in lots of	Unit reference
Mounting plates ⁽¹⁾	For fixing on 1 rail	Clip-on	1	LA9D973
	For fixing on 2 rails	110/120 mm fixing centres	10	DX1AP25
Marker holder	Clip-on	Onto front of contactor	100	LA9D90
Clip-in markers	4 maximum per contactor	Strips of 10 identical numbers 0...9	25	AB1R● ⁽²⁾
		Strips of 10 identical letters A...Z	25	AB1G● ⁽²⁾

Connection accessories

Description	Application		Sold in lots of	Unit preference
Paralleling links	For 2 poles	With screw clamps	4	LA9E01
	For 4 poles	With screw clamps	2	LA9E02
Set of 6 power connections	For 3-pole reversing contactors for motor control	For contactors with screw clamp terminals	100	LA9K0969
Set of 4 power connections	For 4-pole changeover contactor pairs	For contactors with screw clamp terminals	100	LA9K0970

⁽¹⁾ Order 1 mounting plate for fixing a contactor and 2 mounting plates for fixing a reversing contactor.

⁽²⁾ Complete the reference by replacing the dot with the required character.