

› Plug-In Timer 8 pins

- › Multifunction or monofunction
- › Compact body for space saving
- › Wide time range (from 0.5 seconds to 10 days delay)
- › Universal power supply (12-240 V \sim)
- › 1 or 2 relay outputs (SPDT / Changeover)
- › Protective cover
- › LED status indicator
- › 3-wire PNP sensor compatible
- › 8-pins connections



OU1R10MV1
Multifunction U -
Monofunction Ad - N



OA2R10MV1
Monofunction A



OC1R10MV1
Monofunction C



OL1R10MV1
Monofunction L - Li

Product selection			
Function	Output	Supply Voltage	Part Number
Multifunction U: (A, At, B, C, H, Ht, D, Di, Ac, Bw) Ad - N	1 relay	12 to 240 V \sim	OU1R10MV1
A	2 relays	12 to 240 V \sim	OA2R10MV1
C	1 relay	12 to 240 V \sim	OC1R10MV1
L - Li	1 relay	12 to 240 V \sim	OL1R10MV1

PART NUMBERING SYSTEM

Type

O: Plug-in 8-Pins
P: Plug-in 11-Pins

Output Quantity

1: 1 Output
2: 2 Outputs

Output Power

10: 10 A

O

A

1

R

10

MV1

Function

A: ON-Delay
C: OFF-Delay
L: Repeat Cycle
U: Multifunction U

Output Type

R: Relay

Power Supply

MV1: 12-240V AC/DC

You have a project? Contact us on www.crouzet.com

Description:

Syr-line, the new specialized range at Crouzet, aimed to satisfy the most unique requirements of your applications by innovating in design, engineering and development.

The Plug in Analog Timers, a new family of 8 timers with multifunction or monofunction, universal power supply, wide time range, with all the classic functions.

For more information about Crouzet's Syr-line range, please visit www.crouzet.com.

	OU1R10MV1	OA2R10MV1	OC1R10MV1	OL1R10MV1
Power Supply				
Rated supply voltage Un	12 to 240 V \sim			
Voltage supply tolerance	-15 %, +10 %			
AC supply voltage frequency	50 / 60 Hz \pm 5%			
Galvanic isolation of supply / inputs	No			
Power consumption @ Un	Approx. 3 VA (VAC) 1.5 W (VDC)			
Immunity to power micro cuts	10 ms			
Timing Control				
Specified time ranges (7) (IEC 1812-1)	0.5..10 s, 0.05..1 min, 0.5..10 min, 0.05.. 1h, 0.5..10 h, 0.05..1 day, 0.5..10 days			
Minimum control pulse duration (IEC 1812-1)	40 ms 100 ms with load			
Recovery time (after by de-energisation) (IEC 1812-1)	120 ms			
Repeatability (IEC 1812-1)	$\leq \pm 0.5$ %			
Setting Accuracy (IEC 1812-1)	$\leq \pm 10$ %			
Temperature drift	$\leq \pm 0.05$ % / $^{\circ}$ C			
Voltage drift	$\leq \pm 0.2$ % / V			
Relay output				
Contact arrangement	1 CO (SPDT) (ChangeOver -Single Pole Double Throw-)	2 CO (SPDT) (ChangeOver -Single Pole Double Throw-)	1 CO (SPDT) (ChangeOver -Single Pole Double Throw-)	
Maximum switching voltage	250 V \sim / 10 A resistive / 125 V --- / 0.3 A resistive			
Switching current rate (resistive)	NO / NC: 10 A 250 V \sim / 10 A 30 V --- @ 40 $^{\circ}$ C NO / NC: 8 A 250 V \sim / 8 A 30 V --- @ 60 $^{\circ}$ C	NO / NC: 10 A 250 V \sim / 10 A 30 V --- @ 25 $^{\circ}$ C NO / NC: 5 A 250 V \sim / 5 A 30 V --- @ 60 $^{\circ}$ C	NO / NC: 10 A 250 V \sim / 10 A 30 V --- @ 40 $^{\circ}$ C NO / NC: 8 A 250 V \sim / 8 A 30 V --- @ 60 $^{\circ}$ C	
Minimum switching contact	10 mA / 5 V ---			
Maximum switching power (resistive)	2500 VA / 300 W			
Electrical life	10 ⁵ cycles min at 250 V \sim / 10 A resistive(NO only)			
Maximum rate (at max switching power)	360 cycles /hour			
Mechanical life	10 x 10 ⁶ cycles			
Rated impulse voltage	4 kV (1.2/50 μ s)			
Dielectric strength between coil / contacts (IEC 60664-1)	2.5 kV / 1 min / 1 mA / 50 Hz			
Dielectric strength between open contacts	1 kV / 1 min / 1 mA / 50 Hz			
Insulation				
Rated Insulation voltage (IEC 60664-1)	250 V			
Insulation coordination (IEC 60664-1)	Overvoltage category III; pollution degree 2; up to 2 000 m above sea level			
Rated impulse voltage (IEC 60664-1)	4 kV (1.2/50 μ s)			
Clearance / Creepage distances (IEC 60664-1)	3 mm / 3.2 mm			
Dielectric strength (EN-61812-1)	2.5 kV / 1 min / 1 mA / 50 Hz			
Insulation Resistance (NFC 93 050)	> 500 MOhms / 250 V --- / 1 min			
General specifications				
Status indication (LED)	Un: green LED blinks when count, flash when waiting Y1, continuous ON when supplied R: yellow LED blink when only R2 is ON (instantaneous), continuous ON when the 2 relays are ON.			
Casing	35 mm			
Mounting	Mounting base-mounted on socket			
Housing material (UL94)	Enclosure plastic type V0			
Degree of protection (IEC 60529)	IP40			

	OU1R10MV1	OA2R10MV1	OC1R10MV1	OL1R10MV1
Operating temperature (IEC 60068-2)	-20 °C to +60 °C			
Storage temperature (IEC 60068-2)	-40 °C to +70 °C			
Humidity (IEC 60068-2-30)	93 % without condensation			
Vibration resistance (IEC 60068-2-6)	± 0.15mm from 10 Hz...60 Hz 2g from 60 Hz..150 Hz			
Shock resistance (IEC60068-2-27)	10 gn - 11ms ; 3 x 6 axis (Output non-energized) 5 gn - 1 ms ; 3 x 6 axis (Output energized)			
Drop to concrete floor (IEC 60068-2-32)	High: 0.75 m			
Weight	90 g 110 g with packaging			

Standards

CEE Directive (2014/30/EU 2014/35/EU)	EMC Low voltage
Approvals / Marking	CE cULus Listed Industrial Control Equipment
Security standard (IEC 60664-1)	Insulation coordination for equipment within low-voltage systems
Conformity with environmental directives (2015/863/UE 1907/2006 2012/19/UE)	RoHS Reach WEEE
Product standard (IEC 61812-1 UL 60947-4-1)	Specified time relays for industrial use Industrial Control Equipment (NRNT- Industrial Control Switches) Refer to UL840 InsulationCoordinationfor Electrical Equipment
Electromagnetic compatibility (IEC 61000-6-2 IEC 61000-6-3 IEC 61000-6-4)	Generic standards Immunity for industrial environment Emission residential environment Emission industrial environment
Immunity to electrostatic discharges (IEC61000-4-2)	Level III Air ± 8 KV / Contact ± 6 KV
Immunity to radiated, radio-frequency, electromagnetic field (IEC61000-4-3)	Level III 10V/m (80 MHz to 1 GHz) 80% AM (1 kHz) 3 V/m (1.4 to 2 GHz) 80% AM (1KHz) 1 V/m (2 to 2.7 GHz) 80% AM (1KHz)
Immunity to rapid transient bursts (IEC 61000-4-4)	direct ±4kV 5/50 Tr/Th ns 5 Kkz & 100KHz Capacitive coupling clamp ± 2 KV 5/50 Tr/Th ns 5 KHz & 100 KHz
Immunity to shock waves on power supply (IEC 61000-4-5)	Level III: line-to-earth ±2kV / line-to-line ±1kV
Immunity to radiofrequency in common mode (IEC 61000-4-6)	Level III: 10 Vrms (0.15 to 80 MHz) 80 % AM (1 kHz)
Immunity to voltage dips and breaks (IEC 61000-4-11)	0 % residual voltage during 1 cycle (Crit. B) 40 % residual voltage / 10 cycles 50Hz / 12 cycles 60Hz (Crit. C) 70 % residual voltage / 25 cycles 50Hz / 30 cycles 60Hz (Crit. C) Short interruptions: 0 % residual voltage / 250 cycles 50Hz / 300 cycles 60Hz (Crit. C)
AC/DC main port emissions (IEC 61000-6-3 IEC 61000-6-4)	CISPR 16-2-1 (7.4.1), CISPR 16-1-2 (4.3) 0.15 MHz – 0.5 MHz, 66 dB(µV) – 56 dB(µV) quasi-peak, 56 dB(µV) – 46 dB(µV) average 0.5 MHz – 5 MHz, 56 dB(µV) quasi-peak, 46 dB(µV) average 5 MHz – 30 MHz, 60 dB(µV) quasi-peak, 50 dB(µV) average CISPR 14-1 0.15 MHz – 30 MHz CISPR 16-2-1 (7.4.1), CISPR 16-1-2 (4.3) 0.15 MHz – 0.5 MHz, 79 dB(µV) quasi-peak, 66 dB(µV) average 0.5 MHz – 30 MHz, 73 dB(µV) quasi-peak, 60 dB(µV) average
Radiated emissions (IEC 61000-6-3 IEC 61000-6-4)	CISPR 16-2-3 30 MHz – 230 MHz, 30 dB(µV/m) Quasi-peak at 10 m 230 MHz – 1 000 MHz, 37 dB(µV/m) Quasi-peak at 10 m Or: 30 MHz – 230 MHz, 40 dB(µV/m) Quasi-peak at 3 m in a semi-anechoic chamber 230 MHz – 1 000 MHz, 47 dB(µV/m) Quasi-peak at 3 m in a semi-anechoic chamber

OU1R10MV1

OA2R10MV1

OC1R10MV1

OL1R10MV1

Function Diagrams

Basic Time Chart

Function A - On-Delay (Delay on make)

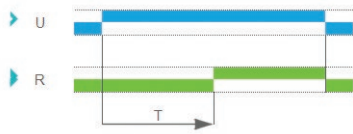

Function Ac - On/Off Delay (Delay on make/break)

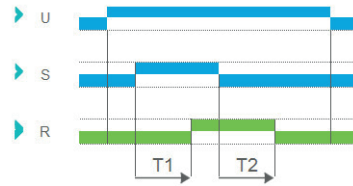

Function Ad - Delay on Start

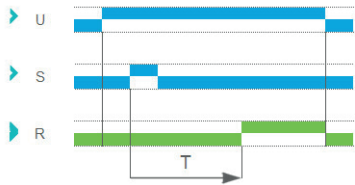

Function At - Summation time relay



Function B - One-Shot

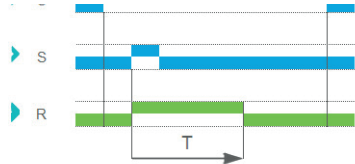

Function Bw

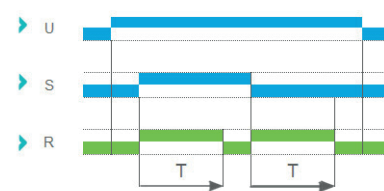

Function C - Off-Delay (Delay on break)

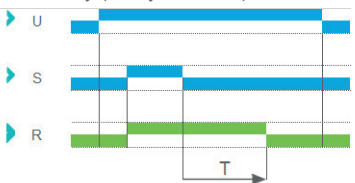

Function D - Symmetrical flashing (OFF Start)

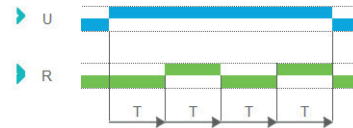

Function Di - Symmetrical flashing (ON Start)

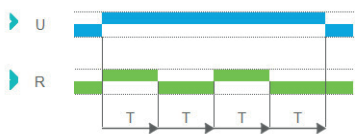

Function H - Interval



Function Ht - Interval summation time relay

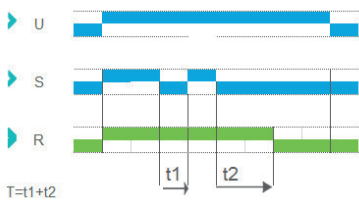

Function L - Recycler (OFF Start)

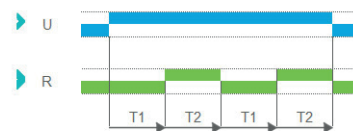

Function Li - Recycler (ON Start)



Function N - Watchdog

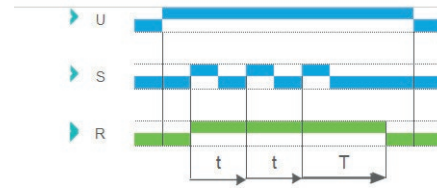

OU1R10MV1	OA2R10MV1	OC1R10MV1	OL1R10MV1
-----------	-----------	-----------	-----------

Connections

OU1R10MV1 - OC1R10MV1

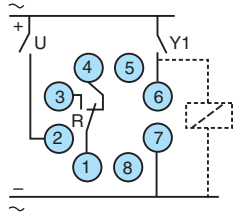

OA2R10MV1

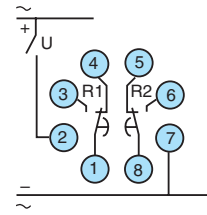

OL1R10MV1

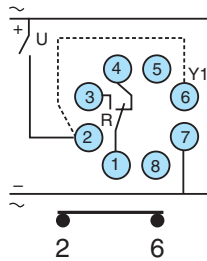

OU1R10MV1	OA2R10MV1	OC1R10MV1	OL1R10MV1
-----------	-----------	-----------	-----------

Outline dimensions (mm)

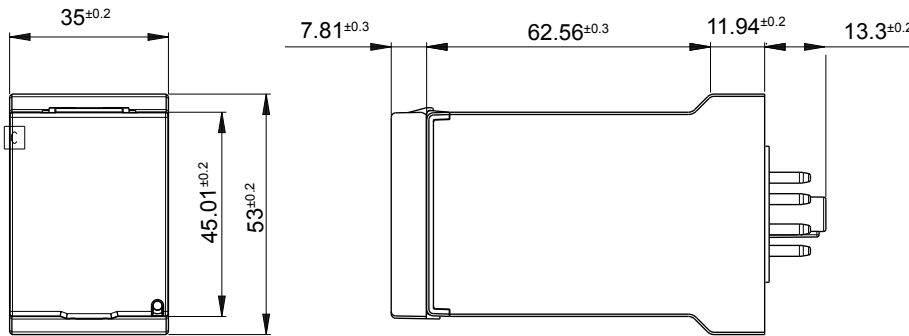

OU1R10MV1	OA2R10MV1	OC1R10MV1	OL1R10MV1
-----------	-----------	-----------	-----------

Socket

RECOMENDED SOCKET

8 Pins for DIN Rail or Panel Mount (P/N: 25 622 130)



Warning:

The product information contained in this catalogue is given purely as information and does not constitute a representation, warranty or any form of contractual commitment. Crouzet Automatismes SAS and its subsidiaries reserve the right to modify their products without notice. It is imperative that we should be consulted over any particular use or application of our products and it is the responsibility of the buyer to establish, particularly through all the appropriate tests, that the product is suitable for the use or application. Under no circumstances will our warranty apply, nor shall we be held responsible for any application (such as any modification, addition, deletion, use in conjunction with other electrical or electronic components, circuits or assemblies, or any other unsuitable material or substance) which has not been expressly agreed by us prior to the sale of our products.