

# › GN Fast-on Series

## Fast-on Solid State Relays

### Panel Mount – Single channel

- › 25 A in a classic Hockey Puck package
- › Fast-on terminals for easy installation in applications that control resistive loads
- › Zero Cross Turn-On
- › cRUus, CE and UKCA Recognized



84134017N

Product Selection - Zero Cross (Resistive Loads)	
Rated Load Current	25 A
Output Voltage	24-280 V~
Control Voltage	
4-30 V~	84134017N

Part number system
GN Fast-on

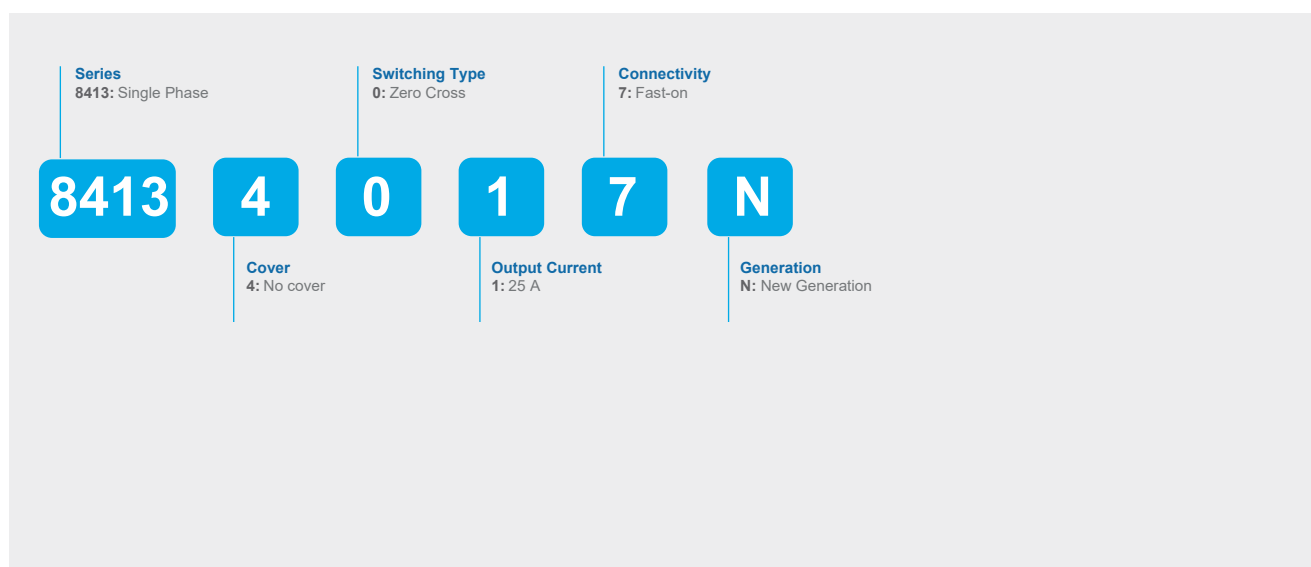

Do you need an adapted or customized solution? Contact us on [www.crouzet.com](http://www.crouzet.com)

#### Description:

Crouzet Solid State Relays are designed to be used in almost any application, offering very long life expectancy and are easy to install, easy to use, robust and multipurpose.

For more information about Crouzet's Solid State relays, please visit [www.crouzet.com](http://www.crouzet.com).

Accessories		
Type	Description	Part-Number
Heatsink	0.9 °C/W Thermal Resistance	26532752N
Heatsink	1.1 °C/W Thermal Resistance	26532753N
Heatsink	1.2 °C/W Thermal Resistance	26532754N
Heatsink	1.75 °C/W Thermal Resistance	26532755N
Heatsink	2.2 °C/W Thermal Resistance	26532756N
Adapter	DIN Rail	26532764N
Thermal Pad	Pre-cut Thermal Pad	26532720N
Thermal Pad	Self-Adhesive Thermal Pad	26532722N
Screws	Screw Mounting Kit	26532001
Thermal Grease	Thermal Grease for Heatsink mounting	26532003

Output Characteristics <sup>(1)</sup>	
Description	25 A
Operating Voltage (40-440 Hz) [Vrms]	24-280
Maximum Load Current [mArms] <sup>(2)</sup>	25 @ 40 °C
Minimum Load Current [mArms]	50
Transient Overvoltage [Vpk]	600
Maximum Surge Current (50/60 Hz (Typ. @ 50Hz), 1 Cycle) [Apk]	250/260 (min) 340 (typ)
Maximum I <sup>2</sup> t for Fusing (50/60 Hz 1/2 cycle) [A <sup>2</sup> sec]	340 (min) 600 (typ)
Minimum Off-State dv/dt @ Maximum Rated Voltage [V/μsec]	500
Maximum Off-State Leakage Current @ Rated Voltage [mArms]	1
Maximum On-State Voltage Drop @ Rated Current [Vrms]	1.25
Thermal Resistance Junction to Case (Rjc) [°C/W]	0.9
Minimum Heatsink for Rated Current @ 40 °C [°C/W] <sup>(2)</sup>	1.9
Minimum Power Factor (Maximum Load)	0.45 (protection required)

Input Characteristics <sup>(1)</sup>	
Description	4-30 V <sub>DC</sub>
Control Voltage Range	4-30 V <sub>DC</sub>
Minimum Turn-On Voltage	4 V <sub>DC</sub>
Must Turn-Off Voltage	1 V <sub>DC</sub>
Maximum Reverse Voltage	-30 V <sub>DC</sub>
Minimum Input Current [mA]	4.5
Maximum Input Current [mA]	50
Nominal Input Impedance [Ω]	600
Maximum Turn-On Time	½ Cycle
Maximum Turn-Off Time	½ Cycle

General Characteristics	
Description	25 A
Dielectric Strength (Vrms)	4000 (Input-Output) 2500 (Output-Case)
Minimum Insulation Resistance (@ 500 V $\overline{--}$ )	10 $\Omega$
Maximum Capacitance, Input/Output	0.8 pF
Ambient Operating Temperature Range	-40 to 80 °C
Ambient Storage Temperature Range	-40 to 100 °C
Housing Material	UL94 V-0
Basplate Material	Aluminium
Terminals	Fast-on (0.25" / 6.3 mm)
Screw Mounting Torque (in-lb/Nm)	11-16/1.2-1.8
Humidity (IEC60068-2-78)	85 % non-condensing
Input Status Indicator	LED - Green
Weight (g)	90
MTBF (Mean Time Between Failure) @ 40 °C (years)	83

General Notes
<sup>(1)</sup> All parameters at 25 °C unless otherwise
<sup>(2)</sup> Heatsink required, see derating curves

## Diagrams

### Wiring

GN Fast-on Serie

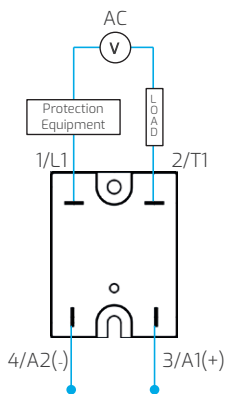

It's recommended to use external overvoltage protection (Varistor / TVS Diode) and short-circuit protection (fuse / circuit breaker), if they are not already integrated

Diagrams

Equivalent Circuit Block

GN Fast-on Series 4-30 V $\overline{\text{---}}$  control Triac - 24-280 V $\sim$  - Zero Cross - 84134017N

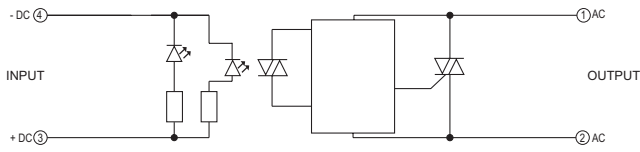

Input current vs Input Voltage  
Standard Regulated DC inputs

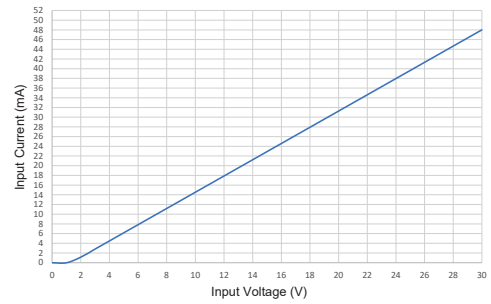

Diagrams

Dimensions (mm)

GN Fast-on Serie

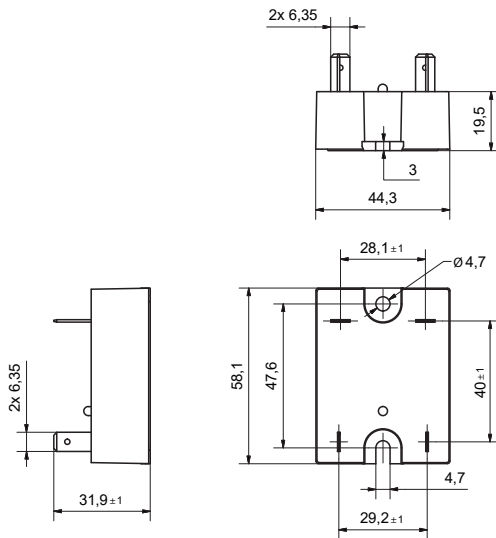

Curves

Surge Current Information

GN Fast-on - 25 A

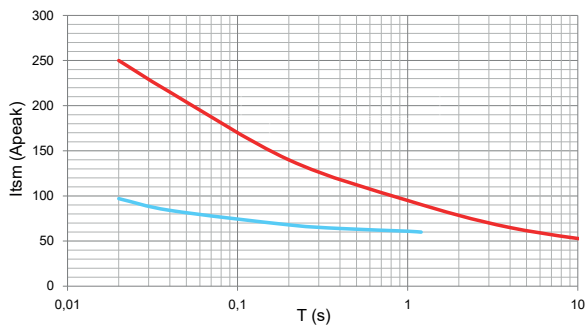

— No Repetitive Surge Current / Tj initial = 25 °C  
— Repetitive Surge Current / Tj initial = 121 °C

Curves

Thermal Derating Curves

GN Fast-on - 25 A

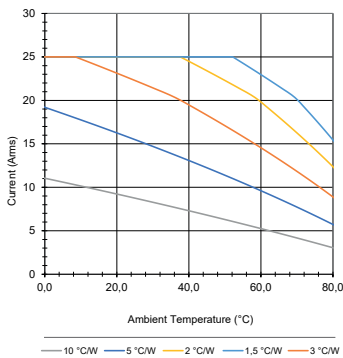

Accessories

Heatsink

0.9 °C/W Thermal Resistance - 26532752N



1.1 °C/W Thermal Resistance - 26532753N



1.2 °C/W Thermal Resistance - 26532754N



1.75 °C/W Thermal Resistance - 26532755N



2.2 °C/W Thermal Resistance - 26532756N



Accessories

Thermal Pad

Pre-cut - 26532720N



Self-Adhesive - 26532722N

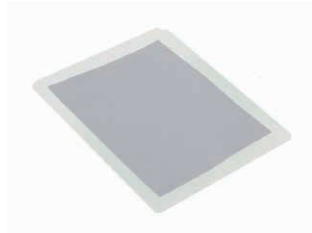

## Accessories

### Others

Screw Mounting Kit - **26532001**



Thermal Grease for Heatsink mounting - **26532003**



DIN Rail - **26532764N**



## Standards & Electromagnetic Compatibility Specification

Designed in accordance with the requirements of IEC 62314

IEC 60068-2-27: Shock Resistance 15 g /11 ms

IEC 60068-2-6: Vibration 0.33 mm / Amplitude over 10-55 Hz

IEC 61000-4-2: Electrostatic Discharge immunity test 8kV air discharge Criterion A Level 3

IEC 61000-4-4: Electrical fast transient/burst immunity test 1kV Line to Line Criterion B Level 3

IEC 61000-4-5: Surge immunity test 1kV Line to Line Criterion B Level 3

## Standards



### Warning:

The product information contained in this catalogue is given purely as information and does not constitute a representation, warranty or any form of contractual commitment. Crouzet and its subsidiaries reserve the right to modify their products without notice. It is imperative that we should be consulted over any particular use or application of our products and it is the responsibility of the buyer to establish, particularly through all the appropriate tests, that the product is suitable for the use or application. Under no circumstances will our warranty apply, nor shall we be held responsible for any application (such as any modification, addition, deletion, use in conjunction with other electrical or electronic components, circuits or assemblies, or any other unsuitable material or substance) which has not been expressly agreed by us prior to the sale of our products.