

EVlink Charging Stations

Commissioning Guide

03/2022



The information provided in this documentation contains general descriptions and/or technical characteristics of the performance of the products contained herein. This documentation is not intended as a substitute for and is not to be used for determining suitability or reliability of these products for specific user applications. It is the duty of any such user or integrator to perform the appropriate and complete risk analysis, evaluation and testing of the products with respect to the relevant specific application or use thereof. Neither Schneider Electric nor any of its affiliates or subsidiaries shall be responsible or liable for misuse of the information contained herein. If you have any suggestions for improvements or amendments or have found errors in this publication, please notify us.

You agree not to reproduce, other than for your own personal, noncommercial use, all or part of this document on any medium whatsoever without permission of Schneider Electric, given in writing. You also agree not to establish any hypertext links to this document or its content. Schneider Electric does not grant any right or license for the personal and noncommercial use of the document or its content, except for a non-exclusive license to consult it on an "as is" basis, at your own risk. All other rights are reserved.

All pertinent state, regional, and local safety regulations must be observed when installing and using this product. For reasons of safety and to help ensure compliance with documented system data, only the manufacturer should perform repairs to components.

When devices are used for applications with technical safety requirements, the relevant instructions must be followed.

Failure to use Schneider Electric software or approved software with our hardware products may result in injury, harm, or improper operating results.

Failure to observe this information can result in injury or equipment damage.

© 2022 Schneider Electric. All Rights Reserved.

Table of Contents



	Safety Information	4
	About the Book	11
Chapter 1	About the commissioning tool	13
Chapter 2	Getting started	15
	Ethernet connection	15
	Description of the User Interface	16
Chapter 3	Configuration	19
	General settings sub-tab	19
	Date and Time settings sub-tab	22
	Network sub-tab	23
	Supervision sub-tab	28
Chapter 4	Energy management and input configuration	31
	Advanced settings sub-tab	31
	Socket-outlets sub-tab	32
	Meters sub-tab	36
Chapter 5	Authentication	41
Chapter 6	Charge Data Record	45
	Charge Data Record	45
	Publication settings sub-tab	46
Chapter 7	Maintenance	49
	Status sub-tab	49
	Report sub-tab	52
	Control sub-tab	53
	Password sub-tab	54
	Firmware Update sub-tab	55
Appendices	57
Appendix A	Appendix	57
	Maintenance report	57



Important Information

NOTICE

Read these instructions carefully, and look at the equipment to become familiar with the device before trying to install, operate, service, or maintain it. The following special messages may appear throughout this documentation or on the equipment to warn of potential hazards or to call attention to information that clarifies or simplifies a procedure.



The addition of this symbol to a “Danger” or “Warning” safety label indicates that an electrical hazard exists which will result in personal injury if the instructions are not followed.



This is the safety alert symbol. It is used to alert you to potential personal injury hazards. Obey all safety messages that follow this symbol to avoid possible injury or death.

DANGER

DANGER indicates a hazardous situation which, if not avoided, **will result in** death or serious injury.

WARNING

WARNING indicates a hazardous situation which, if not avoided, **could result in** death or serious injury.

CAUTION

CAUTION indicates a hazardous situation which, if not avoided, **could result in** minor or moderate injury.

NOTICE

NOTICE is used to address practices not related to physical injury.

PLEASE NOTE

Electrical equipment should be installed, operated, serviced, and maintained only by qualified personnel. No responsibility is assumed by Schneider Electric for any consequences arising out of the use of this material.

A qualified person is one who has skills and knowledge related to the construction and operation of electrical equipment and its installation, and has received safety training to recognize and avoid the hazards involved.



Cybersecurity Safety Notice

WARNING

POTENTIAL COMPROMISE OF SYSTEM AVAILABILITY, INTEGRITY AND CONFIDENTIALITY

- Change default passwords at first use to help prevent unauthorized access to device settings, controls and information.
- Disable unused ports/services and default accounts to help minimize pathways for malicious attackers.
- Place networked devices behind multiple layers of cyber defenses (such as firewalls, network segmentation, and network intrusion detection and protection).
- Use cybersecurity best practices (for example, least privilege, separation of duties) to help prevent unauthorized exposure, loss, modification of data and logs, or interruption of services.

Failure to follow these instructions can result in death, serious injury, or equipment damage.

The EVlink Charging Stations can be connected to an Ethernet network.

Product owners are responsible for the security of the networks in which the EVlink charging station is deployed.

The EVlink Charging Station is not designed to be used as an internet-facing server and it is intended to be used in a trusted network environment.

More information can be obtained by consulting Schneider Electric [recommended cybersecurity best practices](#).

The EVlink Charging Station is embedded with digital firmware that may require the application of security patches when available.

Product owners are invited to consult and register to [Schneider Electric cybersecurity portal](#) to stay informed on newly released or updated Security Notifications.

EVlink Charging Station configuration and maintenance operations are performed through embedded web pages accessible with an administrator user account.

The product does not provide a mechanism to restore the administrator password and in case of password loss, the only way to regain access to the station is to perform a restore to factory settings.

Password managers are a recommended and convenient way to define strong passwords while providing good storage security and minimizing the risk of password loss or breach.

“Cybersecurity Capabilities” on page 7 explains about the product security capabilities, supported protocols, potential risks and compensatory controls as well as recommendations to secure the product during its lifecycle.

Cybersecurity Capabilities

Security Features

Security features have been included in the EVlink Charging Station to help the product operate properly and according to its intended purpose.

These features provide security capabilities which are expected to protect the product from potential security threats that could allow disrupting the product operation (availability), modifying the product configuration (integrity) or disclosing information (confidentiality).

The key features are:

- Support for HTTPS when accessing the product embedded webpages,
- Authentication and authorization controls of users when connecting to the embedded webpages,
- Support of TLS security layer for securing OCCP communication with a remote charging station management system (CSMS),
- Signed firmware update mechanism.

The security capability features are aiming at mitigating the threats related to the usage of the EVlink charging station in its intended environment.

However, the effectiveness of these capabilities depend on the adoption and application of the recommendations provided in this chapter to cover the commissioning, operation, maintenance and decommissioning of the EVlink charging station, as well as [recommended cybersecurity best practices](#).

Supported Protocols

The following protocols are supported by EVlink charging stations:

- HTTPS for configuration and maintenance of the charging station from a web browser,
- DCCP for communicating with a charging station management system (CSMS),
- HTTP and FTP for supporting OCCP reporting and maintenance operations,
- Modbus TCP for communicating with supervision systems,
- DHCP for network IP addressing,
- DNS for network name resolution,
- SSDP for network discovery,
- SMTP for email sending.

Potential Risks and Compensating Controls

Area	Issue	Risk	Compensating Control
RFID badges	A badge may be forged or duplicated	If a malicious user gets his hands on an RFID badge, teh malicious user may be able to duplicate it and spoof the identify of a legitimate charging station user	Do not let RFID badges unattended. In case of suspicion of potential badge duplication or forgery, revoke and renew badges
Physical security	A charging station may be subject to tampering attempts	If the charging station is accessed by a malicious user and its content is altered, malfunctions or possible damages may occur	Periodically inspect the charging station for evidences of tampering attempt Install charging stations in a controlled environment or install security cameras

Area	Issue	Risk	Compensating Control
Web server user accounts	Default user account passwords are often the source of unauthorized access by malicious users	If the default passwords are not changed when commissioning the charging station, unauthorized access can occur	Change the default passwords when installing the charging station
	Same user account passwords are used in different charging stations	If a password is known by a malicious user, you can also access to all other station configured with the same password	When installing several charging stations, configure different passwords in each station
Communication protocols	Modbus TCP, SMTP, HTTP, FTP, DHCP, DNS and SSDP are unsecure	If a malicious user has gained access to the network, you can intercept and eavesdrop communications	<p>For transmitting data over an internal network, physically or logically segment the network</p> <p>For transmitting data over an external network, consider encapsulating communications in an encrypted tunnel, a TLS wrapper or a similar solution.</p>

Security Recommendations for Commissioning

Default User Accounts

Default user accounts and credentials are provided with the charging station web server for supporting the initial connections with the product and performing the commissioning phase.

The passwords for these accounts are described in the user documentation. It is thus not safe to keep on using these passwords in the operation phase.

During commissioning, the passwords for these accounts should be replaced by new ones.

The new passwords should follow security best practices such as using a minimum of 8 characters and including at least 1 upper case letter, 1 digit and 1 special character.

Product Web Server Certificate

To support HTTP secure communications as soon as the product is installed, the EVlink charging station is equipped by default with a self-signed X.509v3 certificate (as specified in RFC 5280). This certificate relies on Elliptic Curves cryptographic keys (256 bits).

This certificate allows to setup a HTTPS communication supporting integrity and confidentiality but lacks some enforcements needed to help ensure the communication authenticity (as indicated by most web browsers through a security warning message displayed when connecting to the EVlink Charging Station).

OCCP Communication Security

When configuring the EVlink Charging Station to setup an OCCP connection with a remote Charging Station Management System, use WSS or HTTPS to secure the communication.

Communications relying on plain HTTP or WS do not provide confidentiality and communications may be eavesdropped.

If the remote Charging Station Management System does not support WSS, contact the system vendor.

Security Recommendations for Operation

Maintain the Firmware up-to-date

Security updates and patches are published on a regular basis. To maintain the appropriate level of security in the EVlink Charging Station, verify periodically that the installed firmware is the latest one available. Firmware updates and release notes can be found in Electric Vehicle (EV) Charging product page on www.se.com.

Passwords Renewal

Update passwords on a regular basis, for instance every three to six months, with strong passwords, with a minimum of 12 characters and including at least 1 upper case letter, 1 digit and 1 special character.

Security Recommendations for Decommissioning

The product is equipped and configured with sensitive information, which includes user account identifiers and passwords.

When disposing the product, perform a reset of the product to avoid that sensitive or confidential information is disclosed or reused.

RFID badges must be manually removed from the configuration before performing a restore to factory settings.



At a Glance

Document Scope

This document will guide you through the commissioning of the EVlink City, EVlink Parking and EVlink Smart Wallbox charging stations.

This document concerns only stand-alone charging stations.

NOTE: Only the following charging stations are compatible with software release 3300:

- EVlink Parking (EVF... and EVW...) with datecode greater than 15271.
- EVlink City (EVC...) with datecode greater than 15401.

The screenshot shows the EVlink web interface. At the top, there is a navigation bar with the EVlink logo and links for 'admin', 'Logout', 'English', and 'About'. Below this is a menu with 'Configuration', 'Energy Management', 'Authentication', 'Charge Data Record', and 'Maintenance'. The 'Maintenance' tab is active. On the left, there is a 'Charging station 1' button. The main content area has tabs for 'Status', 'Report', 'Control', 'Passwords', and 'Firmware update'. The 'Report' tab is selected, showing a 'Maintenance Report' for 'Plug #44'. The report is divided into two sections: 'Product Number' and 'Evse Status'. The 'Product Number' section lists various identifiers such as Commercial Ref, Factory Code, Production Date, Production Revision, Batch Number, Unique Identifier, Product ID, Serial Number Part 1, and Serial Number Part 2. The 'Evse Status' section lists details like FW version, FW build number, Web version, Webserver build number, Boot Counter, CPW state, and Cable state.

Product Number	
Commercial Ref	EVB1A22P4ER1
Factory Code	JN
Production Date	16492
Production Revision	05
Batch Number	002
Unique Identifier	005
Product ID	503192A
Serial Number Part 1	1N164250546G1
Serial Number Part 2	1B17551700014

Evse Status	
FW version	3101
FW build number	22
Web version	3101
Webserver build number	22
Boot Counter	177
CPW state	EVSE_Available_StateA
Cable state	Not_Plugged

For diagnosis of charging stations, download the document reference DOCA0117 (*EVlink - Troubleshooting guide*).

This document is intended for:

- staff in charge of commissioning,
- Facility Managers.

A charging station is configured using a computer connected to the charging station.

This document explains how to:

- connect to the commissioning tool,
- view the factory settings and modify them when necessary,
- manage the user badge list,
- update the firmware.

Validity Note

The technical characteristics of the devices described in the present document also appear online. To access the information online:

Step	Action
1	Go to the Schneider Electric home page www.se.com .
2	In the Search box type the reference of a product or the name of a product range. <ul style="list-style-type: none">• Do not include blank spaces in the reference or product range.• To get information on grouping similar modules, use asterisks (*).
3	If you entered a reference, go to the Product Datasheets search results and click on the reference that interests you. If you entered the name of a product range, go to the Product Ranges search results and click on the product range that interests you.
4	If more than one reference appears in the Products search results, click on the reference that interests you.
5	Depending on the size of your screen, you may need to scroll down to see the data sheet.
6	To save or print a data sheet as a .pdf file, click Download XXX product datasheet .

The characteristics that are presented in the present document should be the same as those characteristics that appear online. In line with our policy of constant improvement, we may revise content over time to improve clarity and accuracy. If you see a difference between the document and online information, use the online information as your reference.

Related Documents

Title of Documentation	Reference Number
EVlink - Troubleshooting guide	DOCA0117
Installation guide for EVlink Smart Wallbox charging stations version with socket-outlet	NHA95005
Installation guide for EVlink parking charging stations Installation guide for EVlink City charging stations (French Only)	NHA47410 NHA63897
Installation guide for EVlink Smart Wallbox charging stations version with attached cable	NHA95018
GPRS modem installation guide ref. EVP1MM	NHA72299
4G modem installation guide ref. EVP2MM	QGH38473
4G modem installation guide ref. EVP3MM	NNZ2678201
Wi-Fi card installation guide ref. EVP1MWSI	NHA97291

Chapter 1

About the commissioning tool

Introduction

The commissioning tool is composed of Web pages embedded in the charging station. The application is used with a web browser on a computer connected to the charging station.

The present document is embedded in the commissioning tool. Click the ? help item in the commissioning tool to access this document.

With the commissioning tool, you can configure the following parameter settings (non-exhaustive list):

- Define the authentication strategy with the RFID badge. By default (factory setting), all RFID badges are accepted.
- Modify the maximum authorized charging current per charge point.
- Allow the cable to be connected permanently to the charging station, including when there is no vehicle present.
- Activate the energy management functionalities: load shedding and deferred start.
- Balance the charging powers for the charging stations with two charge points.
- Generate maintenance reports

Access rights

There are two levels of access to the commissioning tool: **Admin** and **User**.

NOTICE

MISCONFIGURATION OF IMPORTANT PARAMETERS

Do NOT attempt to follow the instructions described in this document if you are unfamiliar with the installation and operation of EVlink charging stations.

Failure to follow these instructions can result in equipment damage or incorrect operation.

Minimum requirements

Before starting, make sure that you have the necessary rights on your computer to be able to modify its IP address.

The minimum requirements for using the commissioning tool are:

- a computer with:
 - an Ethernet port,
 - a web browser.
- a category 5e or above Ethernet cable.

Access to the Commissioning tool

The commissioning tool can be accessed through a computer using a standard web browser:

- Mozilla Firefox (recommended)
- Google Chrome
- Microsoft Internet Explorer

Chapter 2

Getting started

What Is in This Chapter?

This chapter contains the following topics:

Topic	Page
Ethernet connection	15
Description of the User Interface	16

Ethernet connection

DANGER

HAZARD OF ELECTRIC SHOCK, EXPLOSION, OR ARC FLASH

Wear adapted personal protection equipment (PPE) and follow the security procedures.

Failure to follow these instructions will result in death or serious injury.

There are two ways to connect the computer to the charging station and access the commissioning tool:

- If the charging station is not connected to an Ethernet network:
 - Open the charging station and use a free Ethernet port.
- If the charging station is already connected to an Ethernet network:
 - Connect to this network.

NOTE: You are strongly advised to enable only the wired network interface on the PC that will be connected to the commissioning tool and thus disable the WiFi on the PC.

Computer configuration

Step	Action
1	Check that your computer is physically connected to the charging station and that it is powered on.
2	Open the local network properties menu of your computer.
3	Open Internet Protocol TCP/IP v4 properties.
4	Set the static IP address properties as follows: <ul style="list-style-type: none">• IP address: 192.168.0.x (where x is a number between 241 and 249)• Subnet mask: 255.255.255.0• No default gateway• No DNS server• No proxy

Logging on to the Commissioning tool

Step	Action
1	Open a web browser and type <code>https://192.168.0.102</code> in the URL field. NOTE: If your browser shows a message that the connection is not private, choose to proceed to the connection (for example through the advanced settings of your browser).
2	On the Login page, choose the language, and complete the User name and Password fields. The factory settings appear below.
3	Click Login : if the user name and the password are correct, the commissioning home page appears. Otherwise, an access refusal message appears. ⁽¹⁾ NOTE: Change your password after logging in for the first time.

(1) If you have lost your user password, contact your administrator for assistance. In case of a lost **Admin** password, restore the charging station factory settings (call your Schneider Electric Customer Care for the procedure to follow).

Disconnecting the Commissioning tool

⚠️ ⚠️ DANGER

HAZARD OF ELECTRIC SHOCK, EXPLOSION, OR ARC FLASH

Wear adapted personal protection equipment (PPE) and follow the security procedures.

Failure to follow these instructions will result in death or serious injury.

Step	Action
1	Click the Logout link in the top menu. Then, close the web browser.
2	Disconnect the computer from the Ethernet port.
3	Reset the computer to its initial network settings.

Factory settings

User:

- Username: user
- Password: USER

Admin:

- Username: admin
- Password: ADMIN

NOTE: The password is case sensitive.

Description of the User Interface

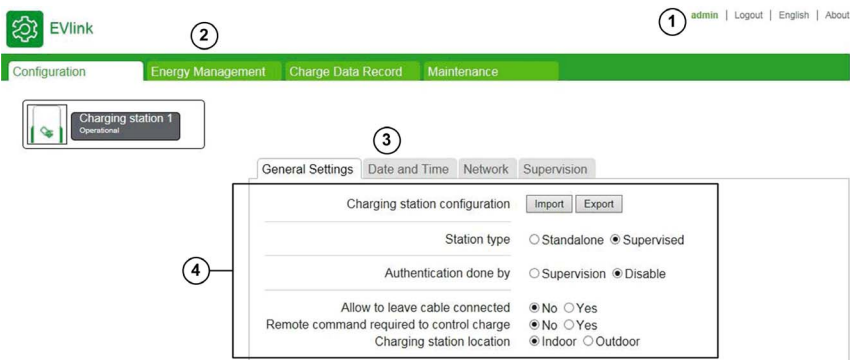

Legend	Zone	Description
1	Connection/Disconnection	<ul style="list-style-type: none"> • User identification area • Logout • Language • About
2	Tabs	<ul style="list-style-type: none"> • Configuration: to modify the charging station parameters. • Energy management: to define the energy management strategy. • Authentication: to manage RFID badges. • Charge Data Record: publication, CDR. • Maintenance: to obtain the version number and upgrade the firmware, to export the maintenance report, to restore the factory settings or to restart the charging station, to modify passwords.
3	Sub-tabs Action buttons Help Button	Sub-tabs corresponding to the page tab selected. Area indicating when the charging station parameters must be Save or Save and reboot . Button to open the online Help.
4	Display area	Display of the parameters corresponding to the tab and sub-tab selected.

During a save and reboot, wait until the status light of the charging station turns off and then on again to be sure that the restart with the new configuration is successfully completed.

NOTE: In the event of a Smart Wallbox charging station with a key lock, make sure that the station is unlocked, otherwise the status light remains off and it is not possible to check that the restart is completed.

Access rights to tabs

According to your configuration, some tabs or sub-tabs can be hidden.

Tab	Sub-tab	Administrator	User
Configuration	General	X	X
	Network	X	–
	Wi-Fi	X	X
	Supervision	X	–
	Time	X	X
Energy management	Advanced Settings	X	–
	Socket Outlets	X	–
	Meter	X	–
Authentication	–	X	X
Charge Data Record	Charge Data Record	X	X
	Publication Settings	X	X
Maintenance	Status	X	X
	Report	X	X
	Control	X	X
	Passwords	X	X
	Firmware update	X	–

Parameter tables

The parameters given in the various tabs and sub-tabs are described in tables with the following format:

Parameter	Access rights		Setting range	Factory setting	Description
	Admin	User			
–	–	–	–	–	–

- **Parameter:** the parameter name
- **Access rights: Admin or User**
 - **N:** parameter not displayed
 - **R:** read-only access
 - **R/W:** read and write access
- **Setting range:** the permitted values for the parameter
- **Factory setting:** the factory setting for the parameter
- **Description:** provides information about the parameter and restrictions that apply

Chapter 3

Configuration

Purpose of the Configuration tab

- Configure the charging station.
- Configure the access to the Ethernet local area network.
- Configure the Wi-Fi card where applicable (as accessory in Smart Wallbox stations only).
- Specify if the charging station is supervised or not and configure the supervision access.
- Specify the time settings of the charging station.

What Is in This Chapter?

This chapter contains the following topics:

Topic	Page
General settings sub-tab	19
Date and Time settings sub-tab	22
Network sub-tab	23
Supervision sub-tab	28

General settings sub-tab

The screenshot displays the EVlink web interface. At the top, there is a navigation bar with tabs for Configuration, Energy Management, Authentication, Charge Data Record, and Maintenance. Below this, a status card shows 'FG 16302 07 002 003' as 'Operational'. The main content area is titled 'General Settings' and includes sub-tabs for 'Date and Time' and 'Network'. The 'General Settings' sub-tab is active, showing configuration options for the charging station. These options include: 'Charging station configuration' with 'Import' and 'Export' buttons; 'Charging station name' set to 'FG 16302 07 002 003'; 'Station type' with radio buttons for 'Standalone' (selected) and 'Supervised'; 'Authentication done by Authentication Strategy' with radio buttons for 'Charging Station' (selected), 'Disable', 'Remote', 'Reject unknown badges', and 'Allow all badges'; 'Allow to leave cable connected' with radio buttons for 'No' (selected) and 'Yes'; and 'Charging station location' with radio buttons for 'Indoor' (selected) and 'Outdoor'.

Parameter list

Setting	Access rights		Setting range	Factory setting	Description
	Admin	User			
Import or Export your Station configuration from/to file RFID badge list not included	R/W	N	Export	–	Saves the actual configuration in a .cfg file.
			Import	–	Replaces the actual configuration with that saved in a .cfg file.
Charging station name	R/W	N	Up to 30 characters	Serial number	Name of the charging station, useful in cluster operations. Accepted characters are A to Z, 0 to 9, space, and +.
Station Type	R/W	R	Standalone	–	Charging station is not connected to a Network or to an OCPP Supervision.
			Supervised	–	Charging station is connected to a LAN (Local Area Network) and/or to an OCPP Supervision (Open Charge Point Protocol).
Remote command required to control charge (charging stations without RFID reader)	R/W	R/W	No	X	No remote command.
			Yes	–	External authorization is required to start the charge, for example, when the station is used in Pay As You Go application. Authorization is sent to the charging station by the supervision further to the user authentication by the application provider via a method independent of the charging station. This parameter does not exist for charging stations with RFID reader that are always compatible with a PAYG application.
Authentication location (without Supervision via OCPP)	R/W	R/W	Charging station	X ⁽¹⁾	The authentication function is enabled; it uses the RFID reader integrated in the charging station. User badges are locally recorded with an Admin badge. For more information about Authentication (see page 41).
			Disable	X	The authentication function is disabled; the charging station is in free access mode.
			Remote	–	Charging authorization is given by a remote system that must not be confused with a supervision via OCPP. The built-in RFID reader, if any, is not used.
Authentication location (with supervision via OCPP)	R/W	R/W	Supervision	X	Charging authorization comes from supervision via OCPP.
			Charging station	–	The authentication function is enabled; it uses the RFID reader integrated in the charging station. User badges are locally recorded with an Admin badge.
			Disable	–	The authentication function is disabled; the charging station is in free access mode.
Authentication strategy ⁽²⁾ (without supervision via OCPP)	R/W	R/W	Reject unknown badges	–	Reject badges that are not recorded in the charging station.
			Allow all badges	X	All RFID badges read by the reader start a charge.
<p>(1) If the charging station is equipped with an RFID reader. (2) This parameter appears only if the Authentication location is set to Charging station. (3) Default value for Smart Wallbox stations with a key. (4) Default value for Smart Wallbox stations with RFID reader.</p>					

Setting	Access rights		Setting range	Factory setting	Description
	Admin	User			
Authentication strategy in the event of loss of communication (with supervision via OCPP)	R/W	R/W	Reject all badges	–	In the event that communication is lost with supervision, access to the charging station is impossible, except for the badges that have been previously authenticated and recorded in the cache memory of the charging station.
			Allow all badges	X	In the event that communication is lost with supervision, the charging station is in open access mode.
			Disable	–	In the event that communication is lost with supervision, the charging station is in open access mode. The RFID reader is deactivated, if present.
Authentication timeout (with supervision via OCPP)	R/W	R	0...999 sec	10 sec	In the event that communication is lost or lazy, the charging station will wait for xx seconds the answer of the supervision to reject the authentication request. During this time, the user can proceed with the connection and begin a load.
Front panel push button activated (Smart Wallbox stations)	R/W	R	Yes	X ⁽³⁾	The button can be used to stop then restart the charging. See the user guide for the charging station to become familiar with the other functions.
			No	X ⁽⁴⁾	The button cannot be used to stop and restart the charging. See the user guide for the charging station to become familiar with the other functions.
Station location	R/W	R	Indoor	X	See next paragraph (<i>see page 21</i>)
			Outdoor	–	
Allow to leave cable connected (Parking charging stations)	R/W	R/W	on	–	See next paragraph (<i>see page 21</i>)
			off	X	
(1) If the charging station is equipped with an RFID reader. (2) This parameter appears only if the Authentication location is set to Charging station . (3) Default value for Smart Wallbox stations with a key. (4) Default value for Smart Wallbox stations with RFID reader.					

Station location parameter

Some types of electric vehicles emit toxic gases during the charge and require building ventilation when they are inside.

The **Station location** parameter defines the charging environment of the electric vehicle:

- Set the **Station location** parameter to **Indoor** (factory setting) if the charging station is installed in a building and is not connected to the building ventilation system. In this configuration, the charging station will stop the charge underway and will generate a notification if the vehicle requires building ventilation.
- Set the **Station location** parameter to **Outdoor** if the charging station is installed outdoors or if it is inside a building and is connected to the building ventilation system.

Allow to leave cable connected parameter

This parameter is only modifiable for Parking charging stations. Setting the **Allow to leave cable connected** to **on** allows the cable to remain connected to the charging station after disconnection of the vehicle without notification.

In the City charging stations, the parameter is not displayed and the factory setting is **off**.

In the Smart Wallbox charging stations, the parameter is not displayed and the factory setting is **on**.

NOTE: Allow to leave the cable connected is only useful to avoid the notification from the charging station. This does not mean that the cable remains locked by the charging station once the vehicle is disconnected. In these conditions, the charging cable is exposed to a risk of theft.

Date and Time settings sub-tab

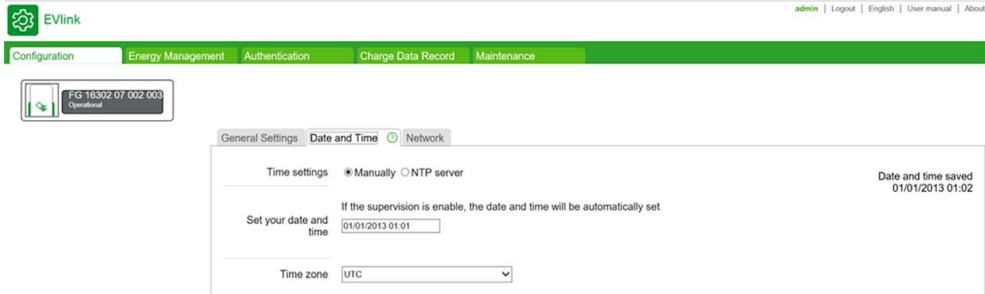

It is important to set the time and date of the charging station to obtain charge logs with a correct timestamp.

Parameter list

Setting	Access rights		Setting range	Factory setting	Description
	Admin	User			
Time settings	R/W	R/W	Manually	X	Manual entry of date and time.
			NTP server	–	The date and time are automatically set by the charging station itself (Internet connection required).

Manual setting

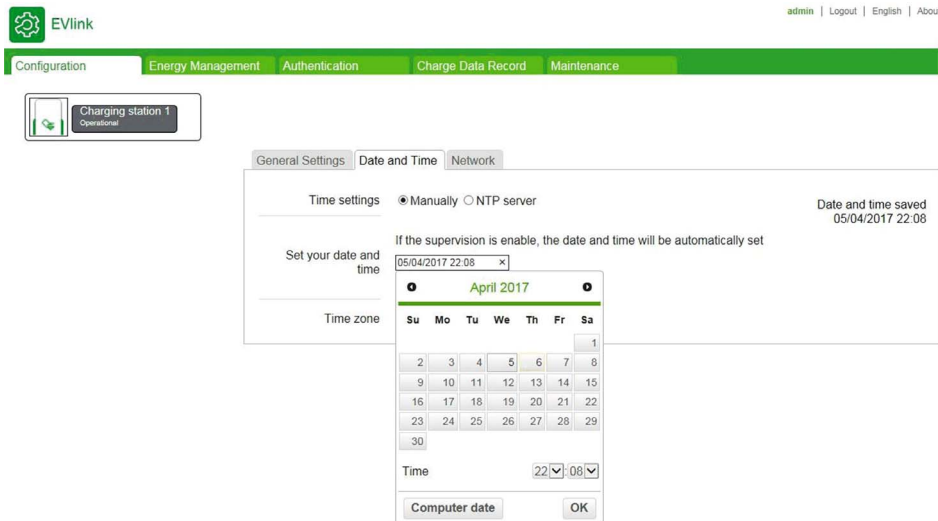

To start, click in the **Set your date and time** entry field. A calendar appears in which you must select date and time. Click **OK** to save the time and date settings.

Time server (NTP) parameter

Setting	Access rights		Setting range	Factory setting	Description
	Admin	User			
Time server (NTP) address	R/W	R/W	up to 200 characters	pool.ntp.org	See next paragraph
Time zone	R/W	R/W	–	–	Select the time zone

The Network Time Protocol (NTP) is used to synchronize the local clock on computers with a reference time. An NTP server is a Web server to which the charging station connects automatically via Internet to synchronize its internal clock with that of the server. There are NTP servers in most countries. Enter the NTP server address in this parameter and make sure that you can ping your NTP server from the charging station in the network. In particular, check that the network settings, the firewall, the DNS are correctly configured.

Network sub-tab

The purpose of this sub-tab is to set the network parameters for the charging station.

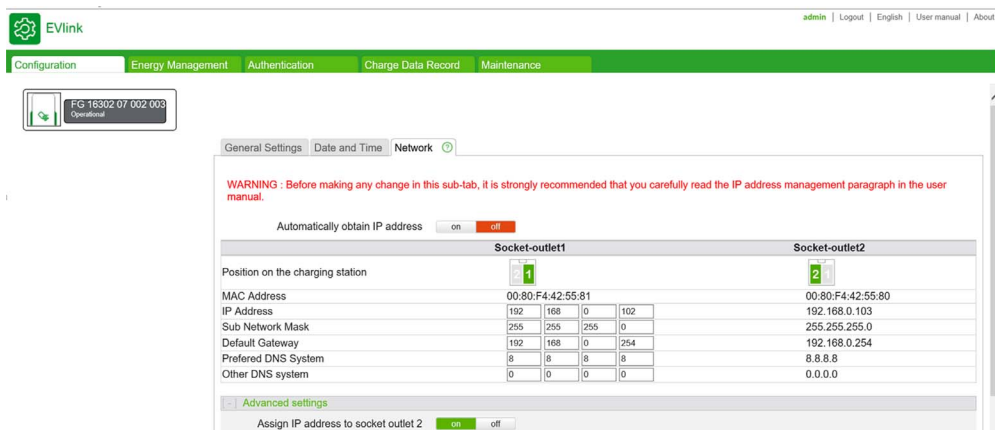

NOTE: Before making any change in this sub-tab, it is strongly recommended that you carefully read the **IP address management** paragraph below.

IP address management

The IP addresses of the charging station, as well as that of the modem as accessory and the Wi-Fi card as accessory in the Smart Wallbox stations, are set at the factory as described below. It should be noted that these addresses follow specific rules that must be followed in the event of modification.

The IP address of the charging station is either static or dynamic. The charging stations delivered with firmware version 3.2 installed are configured to get an IP address automatically from a DHCP server on your network. If your charging station has been updated from version 3.1 or earlier, it will keep its static address.

Dynamic IP management

When this option is activated, the charging station looks for a DHCP server on the network to get an IP address. This feature can be deactivated or activated using the **Automatically obtain IP address** button in the **Network** tab.

It is recommended that you configure your DHCP server to set the longest leasing period possible (for more information, contact your network manager).

Static IP management

The charging station has a static IP address. This IP address was either set by a commissioner/installer or remains at the default value.

	Factory-set IP address(es)	Addressing rules
Charging station with a single charge point	192.168.0.102	X.Y.Z.A
Charging station with two charge points and firmware updated to version 3.2 or higher	192.168.0.102	X.Y.Z.A
	192.168.0.103	X.Y.Z.[A+1]
Charging station with one or two charge points and delivered with firmware version 3.2 or higher	Given by DHCP server or 192.168.0.102 if no DHCP server	X.Y.Z.A
EVlink Wi-Fi card (Smart Wallbox stations)	192.168.0.101	X.Y.Z.[A-1]
EVlink modem	192.168.0.254	–
Commissioning PC	192.168.0.241...249	X.Y.Z.B

Charge points IP addresses

If the charging station is delivered with firmware version 3.2, the 2nd charge point IP address is hidden. If you need this address to be visible, change the **Assign IP address to socket outlet 2 to on** in the commissioning tool (using **Configuration** → **Network** → **Advanced settings**).

Station Name

The default charging station name is based on the serial number (written on the label of the charging station). It is possible to change the name of a charging station under **Configuration** → **General Settings**. This makes it more convenient to identify the charging station from Windows (see next paragraph for more information) (*see page 24*).

Access to the commissioning tool

The PC and the charging station must be in the same sub-network. In the case of static address management, the address of the PC must be fixed and composed of the same first three bytes as those of the address of the charging station. If the IP address of the charging station is the factory setting, it is recommended that you change the PC address as specified in the table of settings (*see page 25*).

In the case of dynamic IP management or if the charging station IP has been changed, you may not know the charging station IP address. To have access to the station, you can use your computer to detect the charging station on the network. On Windows, open the browser and click the network icon (scroll down on the left menu). After a short loading time, the different charging stations present on the network are displayed, named according to their serial number or a custom name (see **Station name** paragraph (*see page 24*)). You can double-click a charging station to open its commissioning tool.

NOTE: On the PC that will be connected to the commissioning tool, you are strongly advised to activate only the wired network interface on the PC and disable the Wi-Fi.

The change in the IP address or addresses of the charging station and that of the Wi-Fi card where applicable is mandatory in the following cases:

- At least two charging stations are on the same local network or share the same modem via an Ethernet connection, all with the same factory-set IP addresses.
- The IP address or one of the IP addresses of the charging station, or the address of the Wi-Fi card, is already used by another device connected to the local network.
- The gateway between the Wi-Fi network and the Internet is not in the same sub-network as the Wi-Fi card of the charging station (the first three bytes of the IP addresses are not identical).

It should be noted that in the event of a change in IP address, you must ensure that all the IP addresses of the charging station and the Wi-Fi card if it is present comply with the addressing rules described in the table above.

In the same way, after a change in IP address of the charging station you must modify the IP address of the commissioning PC so that the charging station and the PC are always in the same sub-network: the first three bytes of the IP addresses must be identical.

A change to a charging station IP address is performed in the **Network** sub-tab. If the charging station is equipped with a Wi-Fi card, you must change the IP address of the card in the **Wi-Fi** sub-tab before changing the IP address of the charging station.

A change to an IP address must take place as follows:

- Make this change off line from the local network and from any other charging station by unplugging the Ethernet cables. If the charging station is equipped with a Wi-Fi card, the Ethernet connection between the two must be maintained.
- Ensure that the new IP addresses are available in the local network.
- For a Smart Wallbox charging station equipped with a key lock, you must ensure that the key is in the unlocked position.

Network architecture

The EVlink modem as accessory acts like a router, it can be shared by more than one charging station sequenced together and connected to the modem in wired Ethernet mode. For more details, refer to EVlink modem documents (*see page 12*).

The Wi-Fi card, available as an accessory in the Smart Wallbox stations only, acts as a bridge: a single station can be connected to the card to access the wireless local area network.

Parameter list

Setting	Access rights		Setting range	Factory setting	Description
	Admin	User			
MAC Address	R/W	R	–	–	–
IP Address	R/W	R	–	192.168.0.102	1st charge point.
		R	–	192.168.0.103	2nd charge point.
Sub Network Mask	R/W	R	–	255.255.255.0	–
Default Gateway	R/W	R	–	0.0.0.0	See the paragraph below.
Preferred DNS System	R/W	R	–	0.0.0.0	–
Other DNS System	R/W	R	–	0.0.0.0	–

Change the charging station IP address

Reminder: If the charging station is equipped with a Wi-Fi card as an accessory, any change in the IP address of the charging station means that the IP address of the Wi-Fi card must be changed as well. This must be done before changing the IP address of the charging station and in accordance with the addressing rules described above.

Be sure to carefully note the new IP address of the charging station so as to be able to enter it later in the browser of the PC used to connect to the commissioning tool. Be careful, if the new IP address is forgotten, the charging station must be reset to the factory settings. Contact Schneider Electric Customer Care for information on this procedure.

Link for mySchneider App download



Default gateway parameter

If the charging station is connected to the EVlink modem as accessory, the default gateway IP address is that of the modem: 192.168.0.254. The IP address of the modem must be changed if the sub-network of the charging station is no longer 192.168.0.X.

If the charging station is equipped with a Wi-Fi card, the IP address of the default gateway is that of the Wi-Fi access point.

Saving modifications and software reboot

Any modification in the **Network** sub-tab implies a software reboot of the charging station to be taken into account: click **Save and Reboot**.



Before the restart the indicator light on the charging station turns off. Then it turns on in green about 30 seconds later when the restart is finished. You must wait for the end of the restart then simply refresh the page on the PC if the IP address of the charging station has not been modified. Otherwise, enter the new IP address of the charging station in the address bar of the PC browser and start browsing. If the charging station has been placed in another sub-network, you must first modify the IP address of the PC to put it in the same sub-network, then enter the new IP address of the charging station in the address bar of the browser and start browsing.

If there is no Wi-Fi card in the charging station, or if no change was made to the configuration of the Wi-Fi card, a simple software reboot is sufficient.

Hide/show second charge point on the network

The 2nd charge point IP address is visible or not, depending on the configuration.

Factory version of the charging station	Default configuration of 2nd charging station visibility
v3.2	Not visible
Others	Visible

You can hide or show the 2nd charge point IP address by using the **Assign IP address to socket outlet 2** in the commissioning tool.

IMPORTANT: If you have decided to hide the 2nd charge point IP address or activate the DHCP feature, the Ethernet cable between the 2 electronic boards must be on the 2nd Ethernet port from the left, on both boards. The commissioning tool generates a notification and refuses to apply this setting without this pre-defined Ethernet cabling.

It is recommended that you hide the 2nd charge point unless you have specific reasons for making it visible (for example, TCP power meter configuration, Modbus energy management, or any action where a Modbus communication is needed on both cards). Hiding the 2nd charge point reduces the chance of having IP address conflicts on the network if you have no DHCP, and reduces the number of IP addresses taken if you have a DHCP.

Hardware reboot (charging station with Wi-Fi card)

Any modification in the **Network** sub-tab implies a software reboot of the charging station to be taken into account (refer to the section **Saving modifications and software reboot**).

If the charging station is equipped with a Wi-Fi card and if the Wi-Fi card configuration was modified, you must:

Step	Action
1	Disconnect your Ethernet cable from the PC.
2	Switch off the power supply of the charging station.
3	Wait five seconds before switching on the power supply.
4	Wait for the indicator light to turn on in green about 30 seconds later.
5	Connect your PC to the Wi-Fi network and enter in your PC browser the new IP address for the charging station in the address bar of the PC browser and start browsing.

NOTE: In the case of a Smart Wallbox charging station with a key lock, ensure that the charging station is not locked before restarting because then the off/on sequence of the indicator light on the front face will not be visible.

Troubleshooting

Symptom	Solutions
Charging station IP address lost	You can use the Windows network browsing feature to access the charging station commissioning tool if you do not know its IP address. The IP address is displayed in the commissioning tool and in the web browser navigation bar.
The commissioning tool rejects DHCP activation or refuses to hide 2nd charging point IP address	<ul style="list-style-type: none"> ● Check that the Ethernet cable between the 2 electronic cards of the charging station is plugged into the Ethernet port in the middle, on each card. ● If not, shut down the charging station. ● Plug the Ethernet cable into the 2nd Ethernet port from the left. ● Power on the charging station. ● Change the DHCP server configuration with the commissioning tool.
DHCP activated or 2nd charge point IP address hidden but communication lost	<ul style="list-style-type: none"> ● Check that the Ethernet cable between the 2 electronic cards of the charging station is plugged into the Ethernet port in the middle, on each card. ● If not, shut down the charging station. ● Plug the Ethernet cable into the 2nd Ethernet port from the left. ● Power on the charging station. ● Check the communication with the commissioning tool. ● If the communication still does not work, use the manual reset to factory setting on both sides of the charging station. Refer to document reference DOCA0117 for more details about the manual reset to factory setting.
Communication lost between Wi-Fi cards	Use the manual reset to factory setting on both sides of the charging station. Refer to document reference DOCA0117 for more details about the manual reset to factory setting.

Supervision sub-tab

This sub-tab is used to configure the charging station so that it can be supervised with OCPP (OCPP stands for Open Charge Point Protocol).

Visit the OCA website for more information about the protocols <https://www.openchargealliance.org/>

The screenshot shows the EVlink configuration interface. At the top, there is a navigation bar with tabs for Configuration, Energy Management, Authentication, Charge Data Record, and Maintenance. The Configuration tab is active. Below the navigation bar, there is a status indicator for 'Smart WB Fabien' which is 'Operational'. A prominent yellow warning box at the top right of the configuration area contains a warning icon and the text 'Please save your configuration and reboot to apply changes when done', with buttons for 'Save', 'Save and reboot', and 'Cancel'. The main configuration area is divided into three sections: 'Main Configuration', 'Modem Configuration', and 'Advanced Configuration'. The 'Main Configuration' section includes fields for 'OCPP Version' (set to 1.5), 'Supervision URL' (http://), and 'Charging station ID' (UNDEFINED). The 'Modem Configuration' section includes a toggle for 'Modem Schneider Electric presents' (set to off), and text input fields for 'Charging station Local Port' (8080), 'Charging station Public IP' (8080), 'Charging station Public Port' (8080), and 'Charging station ReplyTo address' (http://www.w3.org/2005/). The 'Advanced Configuration' section includes text input fields for 'Default User ID Tag' (UNDEFINED), 'Meter Value Sample Interval' (900 sec), 'OCPP Clock Aligned Data Interval' (0 sec), and 'Supervision Connection Timeout' (60 sec), along with two toggle switches for 'Authentication Cache List Enabled' and 'Enable Socket Identifier', both set to off.

Parameter list

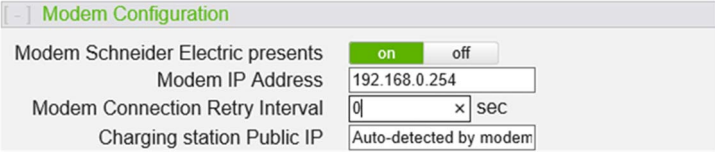
Setting	Description
OCPP Version	OCPP 1.5 SOAP (http) and JSON (ws or wss), or OCPP 1.6 only in JSON (ws, wss, websocket).
Supervision URL	Address of the supervision. It must begin with http://, ws:// or wss:// NOTE: http:// not supported by OCPP 1.6.
Charging station ID	Box identity of the charging station provided by supervision administrator.
Modem Schneider Electric presents	<ul style="list-style-type: none"> If you use an EVP1MM modem (Sierra) or EVP2MM modem (Multitech): <ul style="list-style-type: none"> Select on. Do not modify the Modem IP Address and Charging Station Public IP fields. You can change the Modem Connection Retry Interval value (1...999 sec).  <ul style="list-style-type: none"> If you do not use a Schneider Electric modem or use another type of gateway: <ul style="list-style-type: none"> Select off. Modify the Charging station Public IP field (see parameter described below).
Charging station Local Port	Do not modify this field.
Charging station Public IP	<ul style="list-style-type: none"> If you do not use a Schneider Electric modem or use another type of gateway: <ul style="list-style-type: none"> Select off. Use a SIM card with a static IP address and enter the SIM card IP address in this field.
Charging station Public Port	Port used by supervision administrator to contact the charging station through the modem or router.
Charging station ReplyTo address	Do not modify this field.
Default User ID Tag	If authentication is disabled, this tag is used as customer ID for each session. Empty value is not authorized..
Meter Value Sample Interval	Interval of communication between 2 consumption messages.
OCPP Clock Aligned Data Interval	Update this value only if a Power meter is selected in Energy management tab.
Supervision Connection Timeout	For each message sent, deadline for supervision feedback.
Authentication Cache List Enabled	The last 500 user IDs are memorized and authorized until expiration date (in case of connection loss or lazy communication between charging station and supervision).
Enable Socket Identifier	Do not modify this field, value is off .

Chapter 4

Energy management and input configuration

Purpose of the Energy management tab

This tab allows you to configure:

- **The energy management strategy for distributing the power available for the charging station between the two charge points.**
- The power delivered by the charging station.
- The function inputs: Circuit breaker status, conditional start, Current limitation.
- The power meters.

What Is in This Chapter?

This chapter contains the following topics:

Topic	Page
Advanced settings sub-tab	31
Socket-outlets sub-tab	32
Meters sub-tab	36

Advanced settings sub-tab

The screenshot shows the EVlink web interface. At the top, there is a navigation bar with tabs: Configuration, Energy Management (selected), Authentication, Charge Data Record, and Maintenance. Below the navigation bar, there is a status box for 'FG 16302 07 002 003' with a 'Operational' indicator. To the right, there are sub-tab buttons: Advanced settings (selected), Socket-outlets, and Meters. The Advanced settings sub-tab is expanded, showing two settings: 'Load balancing' with radio buttons for 'Disabled' (selected) and 'Enabled', and 'Controlled by external system' with radio buttons for 'No' (selected) and 'Yes'.

Parameter list

Setting	Access rights		Setting range	Factory setting	Description
	Admin	User			
Load Balancing (City and Parking charging stations)	R/W	N	Disable	-	Power delivered by each charge point is set independently.
			Enable	X	The charging station itself does the power split between the two charge points to avoid tripping.
Load Shedding Priority	R/W	N	Charge duration	X	When the power available for the charging station becomes insufficient for the two on-going charging operations, the one that has started first will be shed first.
			Energy delivered	-	When the power available for the charging station becomes insufficient for the two on-going charging operations, the one that has delivered the most energy will be shed first.
Controlled by external system	R/W	N	NO	X	The charging station cannot be controlled by an external system ⁽¹⁾ .
			Yes	-	An external system ⁽¹⁾ can dynamically set the maximum current of a charging station.

(1) An external system can be either an OCPP supervision or a Building Management System over Modbus.

Socket-outlets sub-tab

Parameter list

DANGER
RISK OF OVERHEATING, EXPLOSION, OR ARC FLASH

Be sure that the supply cable for each charge point of the charging station is properly protected by the upstream circuit breaker, depending on its length and the cross-section of conductors and in compliance with the electrical installation standards in effect, irrespective of the maximum charging current setting.

Failure to follow these instructions will result in death or serious injury.

For each charging point, the following parameters are displayed and can be adjusted.

Setting	Access rights		Setting range	Factory setting	Description
	Admin	User			
Charging station maximum current	R	N	0...64 A	64 A	The charging station itself does the power split between the 2 charge points to avoid tripping. Keep the Rated charging current setting of each socket-outlet at 32 A and put the total available power for the charging station in this field.
Position on the charging station (City and Parking charging stations)	R	N	1 or 2	–	Position of each socket-outlet. <ul style="list-style-type: none"> ● 1 is right ● 2 is left
Socket-outlet type	R	N	T2	–	For each charge point, socket-outlet type or connector type at the end of the attached cable. T2 socket-outlet or attached cable with T2 connector
			T3	–	T3 socket-outlet
			TE	–	Type E domestic socket-outlet
			T2 - TE	–	Unique charge point equipped with one T2 socket-outlet and one type E domestic socket-outlet
			T1	–	Attached cable with T1 connector
Rated charging current	R	N	32 A	32 A	Maximum current the charging station is able to deliver at each charge point.
Derated charging current (City and Parking charging stations)	R/W	N	From 0 A to the value of the Rated charging current	32 A	Maximum current the charging station is authorized to deliver at each charge point further to the derating. If Load Balancing is enabled: <ul style="list-style-type: none"> ● From 0 to 7 A for single-phase charge, the operating value is 0 A. ● From 0 to 13 A tri-phase charge, the operating value is 0 A (To be compliant with EV/ZE Ready.) NOTE: if a single phase EV or cable is connected to a Tri-phase charging station the charge is considered as a single phase charge.

⁽¹⁾ This setting value does not exist for the City charging stations that are provided with an additional input for the circuit-breaker monitoring whatever the use of Function In-1.

Setting	Access rights		Setting range	Factory setting	Description
	Admin	User			
Derated charging current (Smart Wallbox stations)	R/W	N	From 0 A to the value of the Rated charging current	32 A	Maximum current the charging station is authorized to deliver further to the derating. From 0 to 7 A for single-phase charge, the operating value is 0 A. From 0 to 13 A tri-phase charge, the operating value is 0 A (To be compliant with EV/ZE Ready). NOTE: If a single phasis EV or cable is connected to a Tri-phase charging station the charge is considered as a single phasis charge.
Function In-1 (City and Parking charging stations)	R/W	N	Not used	X	No function is associated.
			Protection devices State connected to the board⁽¹⁾	–	The wired Input 1 is connected to the remote contact of the devices protection (circuit breaker and Residual Current Device) in order to monitor their states.
			Load-shedding input	–	The wired Input 1 is used to control the temporary load-shedding of the charge point. To set the load-shedding input, please refer below to the parameter "Load Shedding Set Point"
Function In-2 (City and Parking charging stations)	R/W	N	Not used	X	No function is associated with the input number 2.
			Conditional_Outgoing line	–	The wired Input 2 is used as a condition to start or stop charging.
Normally open (Function In-1/Function In-2) (City and Parking charging stations)	R/W	N	Checked	X	–
			Unchecked	–	
Delayed charging start (Smart Wallbox charging stations)	R/W	N	Normally open	X	The charging start is delayed (or the charging is interrupted when started beforehand) if the contact wired to the corresponding input is closed (voltage = 24 V). Set the parameter to this value if the input for delayed start is not used and not connected.
			Normally closed	–	The charging start is delayed (or the charging is interrupted when started beforehand) if the contact wired to the corresponding input is open (voltage = 0 V).

⁽¹⁾ This setting value does not exist for the City charging stations that are provided with an additional input for the circuit-breaker monitoring whatever the use of Function In-1.

Setting	Access rights		Setting range	Factory setting	Description
	Admin	User			
Local control of temporary charging current limitation (Smart Wallbox stations)	R/W	N	Normally open	X	The charging current is limited if the contact wired to the corresponding input is closed (voltage = 24 V). Set the parameter to this value if the input for temporary current limitation is not used and not connected.
			Normally closed	–	The charging current is limited if the contact wired to the corresponding input is open (voltage = 0 V).
Load Shedding Set Point (City and Parking charging stations)	R/W	N	0 to the value of the maximum charging current possibly derated	0 A	Temporary charging current limitation when the control input is enabled. If Load Balancing is enabled: <ul style="list-style-type: none"> From 0 to 7 A for single-phase charge, the operating value is 0 A. From 0 to 13 A tri-phase charge, the operating value is 0 A (To be compliant with EV/ZE Ready). NOTE: if a single phasis EV or cable is connected to a tri-phase charging station the charge is considered as a single phasis charge.
Setting of local temporary charging current limitation (Smart Wallbox stations)	R/W	N	0 to the value of the maximum charging current possibly derated	0 A	Temporary charging current limitation when the control input is enabled. From 0 to 7 A for single-phase charge, the operating value is 0 A. From 0 to 13 A tri-phase charge, the operating value is 0 A (To be compliant with EV/ZE Ready). NOTE: if a single phasis EV or cable is connected to a tri-phase charging station the charge is considered as a single phasis charge.
(1) This setting value does not exist for the City charging stations that are provided with an additional input for the circuit-breaker monitoring whatever the use of Function In-1.					

Meters sub-tab

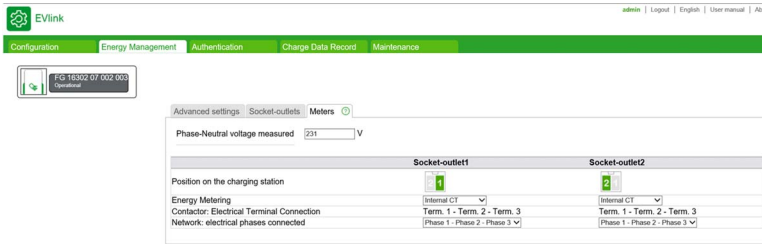

Energy metering is achieved per charge point for the charging stations with two charge points. This can be done without adding meters when it is based on the measurement of the charging current using current transformers inside the charging station, and on the value of the measured phase neutral voltage that has been entered in the **Phase-Neutral Voltage measured**.

NOTE: Internal energy metering is based on the measurement of the apparent power, in other words, it does not take into account the power factor (cos Φ).

To obtain more accurate measuring a meter (one per charge point) must be installed and connected inside or outside of the charging station depending on the version.

Setting	Access rights		Setting range	Factory setting	Description
	Admin	User			
Phase-Neutral Voltage Measured	R/W	N	175 V...276 V	230 V	The value of the phase neutral voltage that has been measured by installer. This value is used only when energy metering is done using current transformers (Internal CT) and also in case of communication lost with power meter. When energy metering is done by power meter, all values V, I, E are read from power meter.

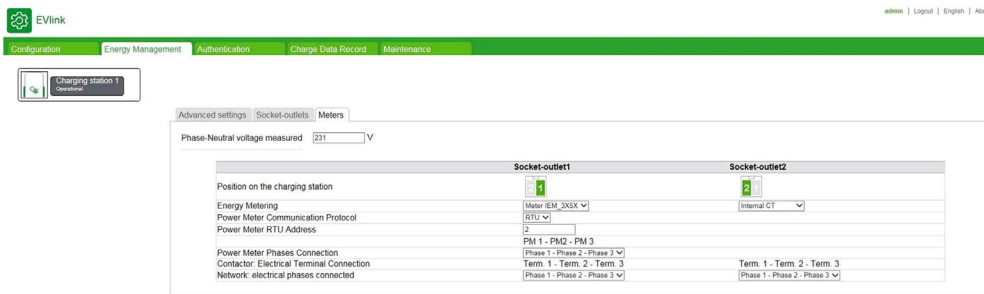

List of Power Meter (for each charge point)

Setting	Access rights		Setting range	Factory setting	Description
	Admin	User			
Energy metering	R/W	R	IEM_3x5x ⁽¹⁾ IEM2155 (1, 2)	–	Use of the additional energy meter for a metering accuracy of less than 1%.
			Internal CT	X	There is no additional energy meter. The current measurement is performed by current transformers inside the charging station. The energy is calculated according to the value of the presumably constant neutral phase voltage, and taking into account the duration of the charge.
			Generic energy meter	–	Use of an external energy meter.

(1) For the meter IEM_3x5x and IEM2155, the parameter values to be entered are as follows:

- **Power meter communication protocol:** select **Modbus RTU** or **Modbus TCP** in the list. The default protocol is **Modbus RTU**.
- **Power meter RTU address:** when **Modbus RTU** is selected, enter a value between 2 and 255. The default value is **2**.
- **Power meter gateway address:** when **Modbus TCP** is selected, enter a value between 130 and 162. The default value is **130**.

(2) The meter IEM_2155 is used for single phase charger only.

Procedure for modifying the parameters of the IEM3155 meter

For power meter configuration, refer to the Quick Start Guide S1B46602:

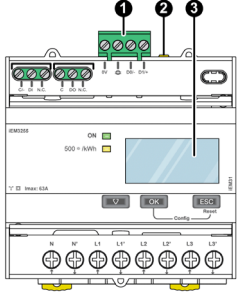
Step	Action	Action																																																																											
1	<p>The parameters to be modified in the meter:</p> <ul style="list-style-type: none"> ● Wiring\Type: 3PH4W (3 phases + Neutral - 4 wires) ● Communication: <ul style="list-style-type: none"> ○ Modbus address: 2 ○ Parity: None ○ Speed: 19,200 bauds ● COM.Protection: COM.Protection: Disable 	–																																																																											
2	<p>Check that the Modbus communication runs properly.</p> <ul style="list-style-type: none"> ● Check that the measurement light blinks after starting a charge with a simulator or the vehicle. ● If the measurement light does not blink, export then open the maintenance report of the charging station (see the Maintenance tab). Refer to the ErrorStatus section Bit 11: DI PowerMeter Comm KO indicates incorrect connection or incorrect configuration. 	 <table border="1"> <thead> <tr> <th>Error Status</th> <th>Plug #102</th> <th>Plug #103</th> </tr> </thead> <tbody> <tr><td>Err #1 - Rfid Reader</td><td>OK</td><td>OK</td></tr> <tr><td>Err #2 - Internal Communication</td><td>OK</td><td>OK</td></tr> <tr><td>Err #4 - Outlet Lock</td><td>OK</td><td>OK</td></tr> <tr><td>Err #5 - Contactor State</td><td>OK</td><td>OK</td></tr> <tr><td>Err #6 - Surge Arrestor</td><td>OK</td><td>OK</td></tr> <tr><td>Err #7 - Anti-intrusion</td><td>OK</td><td>OK</td></tr> <tr><td>Err #8 - Hardware Configuration</td><td>OK</td><td>OK</td></tr> <tr><td>Err #9 - Software Configuration</td><td>OK</td><td>OK</td></tr> <tr><td>Err #10 - Flap Sensor</td><td>OK</td><td>OK</td></tr> <tr><td>Err #11 - Upstream Protection Devices</td><td>OK</td><td>OK</td></tr> <tr><td>Err #12 - Power Meter Communication</td><td>OK</td><td>KO</td></tr> <tr><td>Err #13 - Remote Authentication Communication</td><td>OK</td><td>OK</td></tr> <tr><td>Err #14 - [Un]Plug Process</td><td>OK</td><td>OK</td></tr> <tr><td>Err #15 - Load tri-phase compliance</td><td>OK</td><td>OK</td></tr> <tr><td>Err #16 - Pfc Communication</td><td>OK</td><td>OK</td></tr> <tr><td>Err #17 - Control Pilot (CP) Signal conformity</td><td>OK</td><td>OK</td></tr> <tr><td>Err #18 - Plug Presence (PP) conformity</td><td>OK</td><td>OK</td></tr> <tr><td>Err #19 - Charge Alarm EV Disconnected</td><td>OK</td><td>OK</td></tr> <tr><td>Err #20 - Charge Alarm ShortCut</td><td>OK</td><td>OK</td></tr> <tr><td>Err #21 - Charge Alarm OverLoad</td><td>OK</td><td>OK</td></tr> <tr><td>Err #22 - Charge Alarm Ventilation Not Allowed</td><td>OK</td><td>OK</td></tr> <tr><td>Err #24 - Modem Communication</td><td>OK</td><td>OK</td></tr> <tr><td>Err #30 - Supervision Communication</td><td>OK</td><td>OK</td></tr> <tr><td>Err #31 - NTP Server Communication</td><td>OK</td><td>OK</td></tr> </tbody> </table> <p>1 Communication port 2 Yellow measurement light blinking for active communication 3 Measurement and Configuration Display</p>	Error Status	Plug #102	Plug #103	Err #1 - Rfid Reader	OK	OK	Err #2 - Internal Communication	OK	OK	Err #4 - Outlet Lock	OK	OK	Err #5 - Contactor State	OK	OK	Err #6 - Surge Arrestor	OK	OK	Err #7 - Anti-intrusion	OK	OK	Err #8 - Hardware Configuration	OK	OK	Err #9 - Software Configuration	OK	OK	Err #10 - Flap Sensor	OK	OK	Err #11 - Upstream Protection Devices	OK	OK	Err #12 - Power Meter Communication	OK	KO	Err #13 - Remote Authentication Communication	OK	OK	Err #14 - [Un]Plug Process	OK	OK	Err #15 - Load tri-phase compliance	OK	OK	Err #16 - Pfc Communication	OK	OK	Err #17 - Control Pilot (CP) Signal conformity	OK	OK	Err #18 - Plug Presence (PP) conformity	OK	OK	Err #19 - Charge Alarm EV Disconnected	OK	OK	Err #20 - Charge Alarm ShortCut	OK	OK	Err #21 - Charge Alarm OverLoad	OK	OK	Err #22 - Charge Alarm Ventilation Not Allowed	OK	OK	Err #24 - Modem Communication	OK	OK	Err #30 - Supervision Communication	OK	OK	Err #31 - NTP Server Communication	OK	OK
Error Status	Plug #102	Plug #103																																																																											
Err #1 - Rfid Reader	OK	OK																																																																											
Err #2 - Internal Communication	OK	OK																																																																											
Err #4 - Outlet Lock	OK	OK																																																																											
Err #5 - Contactor State	OK	OK																																																																											
Err #6 - Surge Arrestor	OK	OK																																																																											
Err #7 - Anti-intrusion	OK	OK																																																																											
Err #8 - Hardware Configuration	OK	OK																																																																											
Err #9 - Software Configuration	OK	OK																																																																											
Err #10 - Flap Sensor	OK	OK																																																																											
Err #11 - Upstream Protection Devices	OK	OK																																																																											
Err #12 - Power Meter Communication	OK	KO																																																																											
Err #13 - Remote Authentication Communication	OK	OK																																																																											
Err #14 - [Un]Plug Process	OK	OK																																																																											
Err #15 - Load tri-phase compliance	OK	OK																																																																											
Err #16 - Pfc Communication	OK	OK																																																																											
Err #17 - Control Pilot (CP) Signal conformity	OK	OK																																																																											
Err #18 - Plug Presence (PP) conformity	OK	OK																																																																											
Err #19 - Charge Alarm EV Disconnected	OK	OK																																																																											
Err #20 - Charge Alarm ShortCut	OK	OK																																																																											
Err #21 - Charge Alarm OverLoad	OK	OK																																																																											
Err #22 - Charge Alarm Ventilation Not Allowed	OK	OK																																																																											
Err #24 - Modem Communication	OK	OK																																																																											
Err #30 - Supervision Communication	OK	OK																																																																											
Err #31 - NTP Server Communication	OK	OK																																																																											

Procedure for modifying the parameters of the IEM2155 meter

For power meter configuration, refer to the IEM2100 instruction sheet IIST148-1 and/or user manual 7EN02-0361-00:

Step	Action	Action																																																																											
1	The parameters to be modified in the meter: ● Communication: ○ Modbus address: 2 ○ Parity: None ○ Speed: 19,200 bauds	–																																																																											
2	Check that the Modbus communication runs properly. For this purpose, export or open the maintenance report of the charging station (see the Maintenance tab). Refer to the ErrorStatus section Bit 11: DI PowerMeter Comm KO indicates incorrect connection or incorrect configuration.	<div style="border: 1px solid black; padding: 5px;"> <p>Error Status</p> <table border="1"> <thead> <tr> <th>bit description</th> <th>Plug #102</th> <th>Plug #103</th> </tr> </thead> <tbody> <tr><td>Err #1 - Rfid Reader</td><td>OK</td><td>OK</td></tr> <tr><td>Err #3 - Internal Communication</td><td>OK</td><td>OK</td></tr> <tr><td>Err #4 - Outlet Lock</td><td>OK</td><td>OK</td></tr> <tr><td>Err #5 - Contactor State</td><td>OK</td><td>OK</td></tr> <tr><td>Err #6 - Surge Arrestor</td><td>OK</td><td>OK</td></tr> <tr><td>Err #7 - Anti-intrusion</td><td>OK</td><td>OK</td></tr> <tr><td>Err #8 - Hardware Configuration</td><td>OK</td><td>OK</td></tr> <tr><td>Err #9 - Software Configuration</td><td>OK</td><td>OK</td></tr> <tr><td>Err #10 - Flap Sensor</td><td>OK</td><td>OK</td></tr> <tr><td>Err #11 - Upstream Protection Devices</td><td>OK</td><td>OK</td></tr> <tr style="background-color: yellow;"><td>Err #12 - Power Meter Communication</td><td>OK</td><td>KO</td></tr> <tr><td>Err #13 - Remote Authentication Communication</td><td>OK</td><td>OK</td></tr> <tr><td>Err #14 - [Un]Plug Process</td><td>OK</td><td>OK</td></tr> <tr><td>Err #15 - Load tri-phasis compliancy</td><td>OK</td><td>OK</td></tr> <tr><td>Err #16 - Plc Communication</td><td>OK</td><td>OK</td></tr> <tr><td>Err #17 - Control Pilot (CP) Signal conformity</td><td>OK</td><td>OK</td></tr> <tr><td>Err #18 - Plug Presence (PP) conformity</td><td>OK</td><td>OK</td></tr> <tr><td>Err #19 - Charge Alarm EV Disconnected</td><td>OK</td><td>OK</td></tr> <tr><td>Err #20 - Charge Alarm ShortCut</td><td>OK</td><td>OK</td></tr> <tr><td>Err #21 - Charge Alarm OverLoad</td><td>OK</td><td>OK</td></tr> <tr><td>Err #22 - Charge Alarm Ventilation Not Allowed</td><td>OK</td><td>OK</td></tr> <tr><td>Err #24 - Modem Communication</td><td>OK</td><td>OK</td></tr> <tr><td>Err #30 - Supervision Communication</td><td>OK</td><td>OK</td></tr> <tr><td>Err #31 - NTP Server Communication</td><td>OK</td><td>OK</td></tr> </tbody> </table> <p>1 Communication is not established when KO is present on the line Power Meter Communication.</p> </div>	bit description	Plug #102	Plug #103	Err #1 - Rfid Reader	OK	OK	Err #3 - Internal Communication	OK	OK	Err #4 - Outlet Lock	OK	OK	Err #5 - Contactor State	OK	OK	Err #6 - Surge Arrestor	OK	OK	Err #7 - Anti-intrusion	OK	OK	Err #8 - Hardware Configuration	OK	OK	Err #9 - Software Configuration	OK	OK	Err #10 - Flap Sensor	OK	OK	Err #11 - Upstream Protection Devices	OK	OK	Err #12 - Power Meter Communication	OK	KO	Err #13 - Remote Authentication Communication	OK	OK	Err #14 - [Un]Plug Process	OK	OK	Err #15 - Load tri-phasis compliancy	OK	OK	Err #16 - Plc Communication	OK	OK	Err #17 - Control Pilot (CP) Signal conformity	OK	OK	Err #18 - Plug Presence (PP) conformity	OK	OK	Err #19 - Charge Alarm EV Disconnected	OK	OK	Err #20 - Charge Alarm ShortCut	OK	OK	Err #21 - Charge Alarm OverLoad	OK	OK	Err #22 - Charge Alarm Ventilation Not Allowed	OK	OK	Err #24 - Modem Communication	OK	OK	Err #30 - Supervision Communication	OK	OK	Err #31 - NTP Server Communication	OK	OK
bit description	Plug #102	Plug #103																																																																											
Err #1 - Rfid Reader	OK	OK																																																																											
Err #3 - Internal Communication	OK	OK																																																																											
Err #4 - Outlet Lock	OK	OK																																																																											
Err #5 - Contactor State	OK	OK																																																																											
Err #6 - Surge Arrestor	OK	OK																																																																											
Err #7 - Anti-intrusion	OK	OK																																																																											
Err #8 - Hardware Configuration	OK	OK																																																																											
Err #9 - Software Configuration	OK	OK																																																																											
Err #10 - Flap Sensor	OK	OK																																																																											
Err #11 - Upstream Protection Devices	OK	OK																																																																											
Err #12 - Power Meter Communication	OK	KO																																																																											
Err #13 - Remote Authentication Communication	OK	OK																																																																											
Err #14 - [Un]Plug Process	OK	OK																																																																											
Err #15 - Load tri-phasis compliancy	OK	OK																																																																											
Err #16 - Plc Communication	OK	OK																																																																											
Err #17 - Control Pilot (CP) Signal conformity	OK	OK																																																																											
Err #18 - Plug Presence (PP) conformity	OK	OK																																																																											
Err #19 - Charge Alarm EV Disconnected	OK	OK																																																																											
Err #20 - Charge Alarm ShortCut	OK	OK																																																																											
Err #21 - Charge Alarm OverLoad	OK	OK																																																																											
Err #22 - Charge Alarm Ventilation Not Allowed	OK	OK																																																																											
Err #24 - Modem Communication	OK	OK																																																																											
Err #30 - Supervision Communication	OK	OK																																																																											
Err #31 - NTP Server Communication	OK	OK																																																																											

Parameters for the wiring of phases to the power terminal block and to the energy meter IEM 3155

These parameters are used to describe how the phases are balanced (or not).

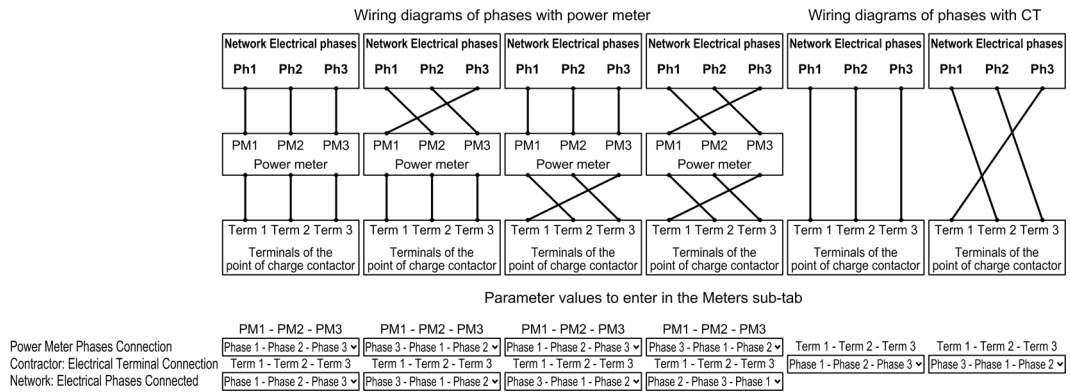

Parameters for the wiring of phases to the power terminal block and to the energy meter IEM2155

Connect the power meter on the phase 1.

Procedure for modifying the parameters of Generic Energy Meters

Refer to your energy meter documentation for details to enter for the parameters.

Single phase parameters:

EVlink Admin | Logout | English | User manual

Configuration | Energy Management | Authentication | Charge Data Record | Maintenance

F_D4_213750_00_000

Advanced settings | Socket-outlets | Meters

Phase-Neutral voltage measured	231 V	
	Socket-outlet1	Socket-outlet2
Position on the charging station	1	2
Energy Metering	Meter generic mono	Meter generic mono
Power Meter Communication Protocol	RTU	RTU
Power Meter RTU Address	4	3
	PM1 - PM2 - PM3	PM1 - PM2 - PM3
Power Meter Phases Connection	Phase1...	Phase1...
Contactor Electrical Terminal Connection	Term 1 - Term 2 - Term 3	Term 1 - Term 2 - Term 3
Network electrical phases connected	Phase1...	Phase1...
Power meter intensity register address (in A)	19013	0
Power meter intensity register size (in 16 bits words)	2	2
Power meter energy register address (in Wh)	19061	19061
Power meter energy register size (in 16 bits words)	2	2
Power meter voltage register address (in V)	19001	19001
Power meter voltage register size (in 16 bits words)	2	2
Power meter power register address (in kW)	19027	19027
Power meter power register size (in 16 bits words)	2	2

Three phase parameters:

EVlink Admin | Logout | English | User manual

Configuration | Energy Management | Authentication | Charge Data Record | Maintenance

F_D4_213750_00_000

Advanced settings | Socket-outlets | Meters

Phase-Neutral voltage measured	231 V	
	Socket-outlet1	Socket-outlet2
Position on the charging station	1	2
Energy Metering	Meter generic tri	Meter generic tri
Power Meter Communication Protocol	RTU	RTU
Power Meter RTU Address	4	3
	PM1 - PM2 - PM3	PM1 - PM2 - PM3
Power Meter Phases Connection	Phase1...	Phase1...
Contactor Electrical Terminal Connection	Term 1 - Term 2 - Term 3	Term 1 - Term 2 - Term 3
Network electrical phases connected	Phase1...	Phase1...
Power meter intensity register phase 1 address (in A)	19013	19013
Power meter intensity register phase 2 address (in A)	19015	19015
Power meter intensity register phase 3 address (in A)	19017	19017
Power meter intensity register size (in 16 bits words)	2	2
Power meter energy register phase 1 address (in Wh)	19066	19066
Power meter energy register phase 2 address (in Wh)	19067	19067
Power meter energy register phase 3 address (in Wh)	19059	19059
Power meter energy register total address (in Wh)	19061	19061
Power meter energy register size (in 16 bits words)	2	2
Power meter voltage register phases 1-2 address (in V)	19007	19007
Power meter voltage register phases 2-3 address (in V)	19009	19009
Power meter voltage register phases 3-1 address (in V)	19011	19011
Power meter voltage register phase 1 - N address (in V)	19001	19001
Power meter voltage register phase 2 - N address (in V)	19003	19003
Power meter voltage register phase 3 - N address (in V)	19005	19005
Power meter voltage register size (in 16 bits words)	2	2
Power meter power register phase 1 address (in kW)	19021	19021
Power meter power register phase 2 address (in kW)	19023	19023
Power meter power register phase 3 address (in kW)	19036	19036
Power meter power register total address (in kW)	19027	19027
Power meter power register size (in 16 bits words)	2	2

Chapter 5

Authentication

Purpose of the Authentication tab

- Display and manage the local list of authorized RFID badges in case of a charging station that is not provided with a supervision via OCPP.

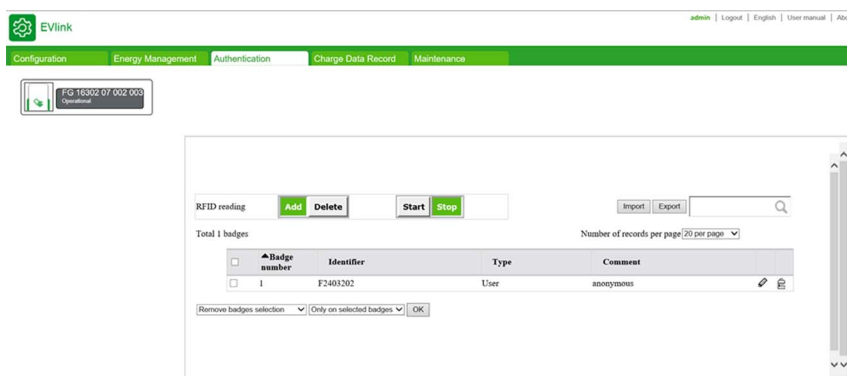

List of badge properties

Properties	Access rights		Setting range	Factory setting	Description
	Admin	User			
Badge number	R	R	–	–	Badge number
Identifier	R	R	–	–	Unique identifier of the badge
Type	R/W	R/W	User	X	Defining the rights associated with the badge
			VIP		
			Admin		
Comment	R/W	R/W	0...50 characters	–	Additional information associated with the badge identifier. This comment will be displayed in the Charge Data Record .

Rights associated with the type of badge

The badge Type (**User**, **VIP**, **Admin**) defines the rights associated with the badge. This Type must not be confused with the account profile (**Admin**, **User**) of the person connected to the commissioning tool.

- **User**: Badge used to charge the electric vehicle in standard mode.
- **VIP⁽¹⁾**: Badge used to charge the electric vehicle in priority mode. When the charging station operates in a **cluster with Energy management**, the station charging a vehicle identified by a VIP badge does not apply reduction or only partially.
- **Admin**: Badge used to manually add or remove **User** badges (refer to the document HRB60015). It can also be used to stop a charge underway started with another badge.
NOTE: An **Admin** badge cannot be used to charge an electric vehicle.

⁽¹⁾ This type of badge is only available for charging stations operating in cluster mode.

Action buttons description

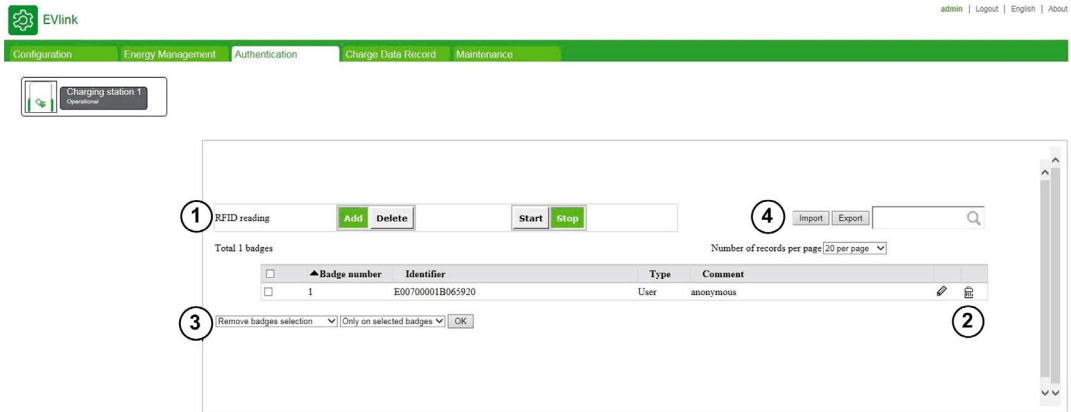

Legend	Action Category	Button Description
1	Manual creation/removal of badges: <ul style="list-style-type: none"> Add badges Remove badges 	<ul style="list-style-type: none"> Add/Delete button: select whether to add or remove badges. Start/Stop button: start or stop the addition or removal.
2	Individual badge management: <ul style="list-style-type: none"> Modify properties Remove badge Save changes Cancel modifications 	<ul style="list-style-type: none"> : allows modification of the badge properties : removes a badge : saves the new badge properties : cancels modifications made to the badge properties that have not yet been saved <p>NOTE: During the modification of the badge properties:</p> <ul style="list-style-type: none"> the button replaces the button the button replaces the button
3	Multiple badge management: <ul style="list-style-type: none"> Remove selected badges Remove all badges Change badge type 	<ul style="list-style-type: none"> Remove badges selection and Remove all badges: refer to the above instructions for removing badges. Change badge type to User, VIP or Admin to modify the associated rights.
4	Management of a whole set of badges: <ul style="list-style-type: none"> Export all badges Import all badges 	<ul style="list-style-type: none"> Export: exports all badges with their properties in a <i>.csv</i> file to create a backup of the list of badges or to copy this list to another charging station.. Import: creates a set of badges with their properties from a <i>.csv</i> file. This function removes all the badges that existed previously.



Adding one or more badges

Step	Action
1	Toggle the Add/Delete button to the Add position.
2	Toggle the Start/Stop button to the Start position.
3	To add several badges, pass them in front of the RFID reader, one after the other. The charging station beeps each time a badge is added.
4	Wait 30 seconds or toggle the Start/Stop button to the Stop position to finish adding badges.

Modifying a badge

The following two badge properties can be modified:

- **Comment**
- **Type**

Step	Action
1	Click the  button.
2	Modify the Comment or Type badge properties.
3	Click the  button to save the changes.

Removing badges

There are three ways to remove badges.

To remove several badges with the RFID reader, proceed as follows:

Step	Action
1	Toggle the Add/Delete button to the Delete position.
2	Toggle the Start/Stop button to the Start position.
3	To remove several badges, pass them in front of the RFID reader, one after the other. The charging station emits a beep each time a badge is removed.
4	Wait 30 seconds or toggle the Start/Stop button to the Stop position to finish removing badges.

To remove several badges with the multiple selection, proceed as follows:

Step	Action
1	Select the badges to be removed by checking the boxes. NOTE: Check the upper left box to select all badges of the current page.
2	Select the Remove badges selection option in the drop-down list.
3	Click OK .

To remove all badges, proceed as follows:

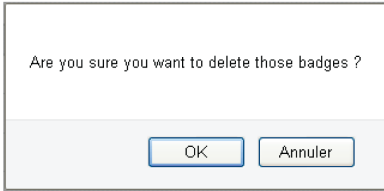
Step	Action
1	Select the Remove all badges option in the drop-down list.
2	Click OK .
3	A dialog box appears.  Click OK to confirm the removal of badges.

Exporting badges

The **Export** function is used to create a backup of the list of badges in a **.csv** file or to copy this list to another charging station.

Step	Action
1	Click Export .
2	Select Save File and click OK . The file is saved in the web browser downloads folder.

Import badges

The **Import** function is used to restore the list of badges or to copy this list from another charging station.

Step	Action
1	Click Import .
2	Click Browse , select the desired <code>.csv</code> file, and click Open .
3	Click the Import button. NOTE: The import operation erases the existing list of authorized badges.

NOTE: It is not possible to export the list of badges, to modify this list and then import it in the same charging station or another charging station.

Chapter 6

Charge Data Record

Purpose of the Reporting tab

- Display or export information relating to the last charging sessions.
- Configure the frequency and the transmission mode of the charging sessions.

What Is in This Chapter?

This chapter contains the following topics:

Topic	Page
Charge Data Record	45
Publication settings sub-tab	46

Charge Data Record

Charge number	Charging station	Socket ID	Transaction ID	UID	Type of charge	Start time	End time	Energy (kWh)	Socket Type	Duration	Comment
10	3N152820234A1S1B7551700014	1	607901	E00700001F8AC3FB	AC_SINGLE_PHASE	2017-04-05 13:40	2017-04-05 13:42	0,000	TYPE2	00:02:20	
9	3N152820234A1S1B7551700014	1	607801	E00700001F8AC3FB	AC_SINGLE_PHASE	2017-04-05 13:22	2017-04-05 13:31	0,000	TYPE2	00:09:06	
8	3N152820234A1S1B7551700014	1	72394		AC_SINGLE_PHASE	2017-04-03 15:22	2017-04-03 15:23	0,000	TYPE2	00:01:24	
7	3N152820234A1S1B7551700014	1	72393	E2EB1C02	AC_SINGLE_PHASE	2017-04-03 15:14	2017-04-03 15:15	0,000	TYPE2	00:00:48	
6	3N152820234A1S1B7551700014	1	1204600930	E2EB1C02	AC_SINGLE_PHASE	2017-03-24 16:14	2017-03-24 16:15	0,000	TYPE2	00:00:54	
5	3N152820234A1S1B7551700014	1	966046093	E2EB1C02	AC_SINGLE_PHASE	2017-03-24 15:51	2017-03-24 15:54	0,000	TYPE2	00:03:34	
4	3N152820234A1S1B7551700014	1	0	E2EB1C02	AC_SINGLE_PHASE	2017-03-24 15:50	2017-03-24 15:50	0,000	TYPE2	00:00:00	
3	3N152820234A1S1B7551700014	1	0	E2EB1C02	AC_SINGLE_PHASE	2017-03-24 15:50	2017-03-24 15:50	0,000	TYPE2	00:00:00	
2	3N152820234A1S1B7551700014	2	635916612	3F420F	AC_SINGLE_PHASE	2017-03-23 10:17	2017-03-23 10:20	0,000	TYPE2	00:02:54	
1	3N152820234A1S1B7551700014	1	420351002	3F420F	AC_SINGLE_PHASE	2017-03-23 10:12	2017-03-23 10:17	0,000	TYPE2	00:05:14	

Export button

The **Export** button inside the sub-tab is used to export all the charging sessions saved in the charging station in a .csv file (up to 3000 charging sessions).

CDR description

CDR (Charging Details Record) refers to the charge log. This sub-tab displays the last thirty charge logs of the charging station with the following data for each charge log:

- Charge number
- Charging station
- Socket ID
- Transaction ID (Transaction identifier from OCPP Supervision)
- Authentication user ID (UID)
- Type of charge detected by the charging station
- Start time of session
- End time of session
- Energy in kWh
- Type of socket-outlet or connector (attached cable)
- Charge duration
- Comment

Publication settings sub-tab

This tab is used to configure how the charging session data is sent.

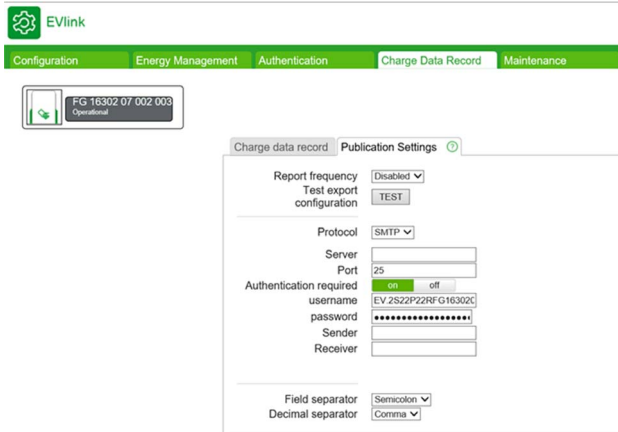

Test button

The **TEST** button is used to test the actual configuration of the charge details reports.

Set up the parameters needed to the protocol you want to use and click the **Save** button. Once the page is reloaded, press the **TEST** button and check if you have received a file. If you have not received the file, there is a problem with the configuration or the connection. In particular, check that the charging station has the required connections, the cables are correctly plugged, the IP or network gateway is correctly configured.

Parameter list

Setting	Access rights		Setting range	Factory setting	Description
	Admin	User			
Report frequency ⁽¹⁾	R/W	R/W	Disabled	X	Daily: Everyday at 0:01 Weekly: Every Monday at 0:01 Monthly: Every 1st of the month at 0:01
			Daily	–	
			Weekly	–	
			Monthly	–	
Protocol	R/W	R/W	SMTP	X	Information given by your network manager.
			FTP	–	
			HTTP	–	
Field separator	R/W	R/W	Semicolon	X	–
			Comma	–	
			Tab	–	
Decimal separator	R/W	R/W	Comma	X	–
			Dot	–	

⁽¹⁾ All data already sent will not be sent again.

SMTP parameters (All these parameters are mandatory and given by your administrator)

Setting	Access rights		Setting range	Factory setting	Description
	Admin	User			
Server	R/W	R/W	–	–	Enter the URL or the IP address of the server.
Port	R/W	R/W	25...587	25	Enter the Port of the Server.
Authentication required	R/W	R/W	On	–	Indicate whether or not authentication is required by the SMTP server.
			Off	X	
Username	R/W	R/W	–	–	Displayed if Authentication required is set to on .
Password	R/W	R/W	–	–	Displayed if Authentication required is set to on .
Sender	R/W	R/W	–	–	The sender address should contain less than 255 characters.
Receiver	R/W	R/W	–	–	Several receiver addresses can be entered and must be separated by a semi-colon (no space before or after). The entry should contain less than 255 characters.

Email queue behavior

An email is created and sent according to the **Report frequency** parameter. If the email does not send, the system tries to send the email once an hour for 7 days (168 retries). After this time, the email is deleted from the system.

The **TEST** button can be used to force a retry.

Example of correct SMTP set-up with a Gmail account:

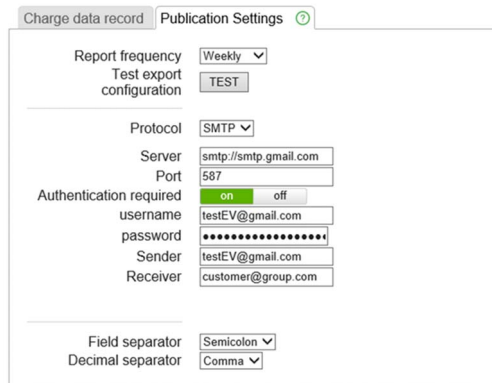

NOTE: Do not forget to activate the SMTP feature of your mail account.

FTP parameters (All these parameters are mandatory and given by your administrator)

Setting	Access rights		Setting range	Factory setting	Description
	Admin	User			
Server	R/W	R/W	–	–	Enter the URL or the IP address of the server.
Authentication required	R/W	R/W	On	–	Indicate whether or not authentication is required by the FTP server.
			Off	X	
Username	R/W	R/W	–	–	Displayed if Authentication required is set to on .
Password	R/W	R/W	–	–	Displayed if Authentication required is set to on .
FTP Port	R/W	R/W	1...9999	21	–
Passive mode	R/W	R/W	on	–	–
			off	X	

HTTP parameters (All these parameters are mandatory and given by your administrator)

Setting	Access rights		Setting range	Factory setting	Description
	Admin	User			
Server	R/W	R/W	–	–	Enter the URL or the IP address of the server.
Authentication required	R/W	R/W	On	–	Indicate whether or not authentication is required by the HTTP server.
			Off	X	
Username	R/W	R/W	–	–	Displayed if Authentication required is set to on .
Password	R/W	R/W	–	–	Displayed if Authentication required is set to on .
HTTP Port	R/W	R/W	1...9999	80	–
Path	R/W	R/W	–	–	Path to copy the files. Should contain less than 100 characters.
Field name	R/W	R/W	–	–	Should contain less than 50 characters.

Chapter 7

Maintenance

Purpose of the Maintenance tab

- Display the live status of the charging station
- Display and export the maintenance report
- Restore the factory settings of the charging station configuration (accessible to the administrator only)
- Restart the charging station
- Modifying the password of the selected account
- Display the software version of the electronic board and the commissioning tool of each charge point
- Display the version of the RFID reader software when applicable
- Upgrade the software

What Is in This Chapter?

This chapter contains the following topics:

Topic	Page
Status sub-tab	49
Report sub-tab	52
Control sub-tab	53
Password sub-tab	54
Firmware Update sub-tab	55

Status sub-tab

This sub-tab displays the live status (refreshed every 5 s) of the charging station, and contains

- Errors
- Status

The screenshot displays the EVlink web interface for the Maintenance tab, specifically the Status sub-tab. The page title is 'EVlink' and the user is logged in as 'admin'. The navigation menu includes Configuration, Energy Management, Authentication, Charge Data Record, and Maintenance. A status indicator shows 'Charging station 1 Operational'. The main content area has tabs for Status, Report, Control, Passwords, and Firmware update. The 'Status' tab is active, showing a 'Live Status' section with a 'Stop automatic Refresh' button. The status is divided into three sections: Error Status, Evse Status, and State of Input/Output. The Error Status section shows an error for Plug #12: 'Power_Meter_Communication'. The Evse Status section shows details for Plug #15 and Plug #16, including CPW state, Cable state, EV state, Last charge status, Evse Status, Outlet Status, and Outlet Status Last Error. The State of Input/Output section shows the status of the 'I_1 Push button: Start' for both plugs, which is 'False'.

Error Status		
	Plug #15	Plug #16
Err #12 - Power_Meter_Communication	KO	OK

Evs Status		
	Plug #15	Plug #16
CPW state	EVSE_Available_StateA	EVSE_Available_StateA
Cable state	Not_Plugged	Not_Plugged
EV state	A_Not_Present_12V	A_Not_Present_12V
Last charge status	Not_Initialized	Not_Initialized
Evse Status	Normal Mode 3 Single-Phase	Normal Mode 3 Single-Phase
Outlet Status	OK_ChargeAuthorisationStarted	OK_ChargeAuthorisationStarted
Outlet Status Last Error	Not_Initialized	Not_Initialized

State of Input/Output		
	Plug #15	Plug #16
I_1 Push button: Start	False	False

Stop automatic refresh

This button allows the automatic refresh to be stopped in order to freeze the status.

Force Refresh

This button is displayed only when the automatic refresh has been stopped. This button allows the status to be refreshed once.

Start automatic refresh

This button is displayed only when the automatic refresh has been stopped. This button allows the automatic refresh to restart.

A message is displayed as follows when an unexpected event has happened:

The screenshot shows the EVlink web interface with the 'Maintenance' tab selected. A 'Stop automatic Refresh' button is visible. The 'Live Status' section is active, showing an event: 'Evt #7 - Anti-intrusion' with a status of 'KO' for both Plug #102 and Plug #103. Below this, the 'Evse Status' table provides detailed information for each plug.

	Plug #102	Plug #103
CPW state	EVSE_Available_StateA	EV_Connected_StateB
Cable state	Not_Plugged	32A
EV state	A_Not_Present_12V	B_Present_9V
Last charge status	Not_Initialized	Not_Initialized
Evse Status	Normal Mode 3 Single-Phase	Normal Mode 3 Single-Phase

A message is displayed as follows when there is no unexpected event:

The screenshot shows the EVlink web interface with the 'Maintenance' tab selected. A 'Stop automatic Refresh' button is visible. The 'Live Status' section is active, showing 'No event found on the charging station' under the 'Event Status' section. The 'Evse Status' table provides detailed information for each plug, including the 'Outlet Status'.

	Plug #102	Plug #103
CPW state	EVSE_Available_StateA	EV_Connected_StateB
Cable state	Not_Plugged	32A
EV state	A_Not_Present_12V	B_Present_9V
Last charge status	Not_Initialized	Not_Initialized
Evse Status	Normal Mode 3 Single-Phase	Normal Mode 3 Single-Phase
Outlet Status	OK_ChargeAuthorisationStarted	OK_ChargeAuthorisationStarted

Cable State is the current capability of the cable connected to the charging point (maximum ampere value).

The following table describes all possible values:

Value
Not_Plugged
13 A
20 A
32 A
63 A_OR_70 A

EV State refers to the communication state between the charging point and the electrical vehicle according to IEC 61851 standard.

The following table describes all possible values:

Value	Vehicle connected	Switch S2	Charge possible	V _a ⁽¹⁾		
A_Not_Present_12V	No	Open	No	12 V ⁽⁴⁾	V _b = 0 V	
B_Present_9V	Yes	Open	No	9 V ⁽²⁾	–	
B_Present_Asked_9V_M12V					Modulation 12 V	
C_Ready_6V	Yes	Closed	Vehicle ready	6 V ⁽³⁾	–	
C_Ready_6V_M12V					Modulation 12 V	
D_Ready_VR_3V					3 V ⁽³⁾	R3 = 270 Ω ±3 % Charging area ventilation not required
D_Ready_VR_3V_M12V					–	
E_ShortCut	Yes	Open	No	0 V	V _b = 0: EVSE, utility power not available, pilot short to earth	
F_NotAvailable	Yes	Open	No	-12 V	EVSE not available	

⁽¹⁾ All voltages are measured after stabilization period, tolerance ±1 V.

⁽²⁾ The EVSE generator may apply a steady state DC voltage or a ±12 V square wave during this period. The duty cycle indicates the available current.

⁽³⁾ The voltage measured is a function of the value of R3.

⁽⁴⁾ 12 V static voltage.

EVSE Status describes the state of the EVSE module.

The following table describes all possible values:

Value	Description
Simplified_Mode_3 or Normal_Mode_3	–
Ventilation required	The EV requires an external ventilation to extract gas or reduce temperature
Cluster_Mode	The Charging station is part of cluster
Single-Phase or Three-Phase	–
Domestic cable detected	–
VIP badge mode	–
Unavailable_OCPC_Cmd_Received	The charging station is unavailable due to an OCCP command.
not_Enough_Energy_To_Start_Charge	The energy available is not enough to start the charge.
Charge_Postpone	The charging session is postponed by a Modbus command
Maintenance_PlC_Cmd_Received	The maintenance mode has been enabled by a Modbus command
Booked_PlC_Cmd_Received	The reservation has been enabled by a Modbus command
Suspend_PlC_Cmd_Received	The charging session is suspended by a Modbus command
Unavailable_PlC_Cmd_Received	The charging station is unavailable due to a Modbus command.

Outlet Status is dedicated to Schneider Electric Experts.

The following table describes all possible values:

Value
OK_ChargeAuthorisationStarted
OK_ChargeAuthorisationDone
OK_ChargeContractStarted
OK_ChargeContractDone
OK_PlugProcedureStarted
OK_PlugProcedureDone
OK_ChargeLoopStarted
OK_ChargeLoopEnded
OK_UnplugProcedureStarted
OK_UnplugProcedureDone
OK_MaintenanceCity
OK_InitDone
OK_Unavailable
Not_Initialized

OutletStatusLastError provides information about the last unexpected event related to socket-outlet.

Value	Description
ChargeAuthorisation error	
KO_BadgeUnknown	RFID badge not authorized (local or supervised)
KO_BadgelsNotTheBooker	RFID badge not authorized according to current reservation
Plug error	
KO_PlugOrShutterAbnormallyLocked	Lock mechanism is in an abnormal final state
KO_ShutterNotOpened	Link with Outlet Status state OK_PlugProcedureStarted: Shutter not opened
KO_PlugNotDetected	Link with Outlet Status state OK_PlugProcedureStarted: Cable not detected
KO_EvNotDetected	Link with Outlet Status state OK_PlugProcedureStarted: Car not detected
KO_PlugOrShutterAbnormallyNotLocked	Link with Outlet Status state OK_PlugProcedureStarted: Unlock Mechanism not working
KO_PlugProcedureError	Link with Outlet Status state OK_PlugProcedureStarted: Other events
Charge error	
KO_BadgelsNotTheCurrentUser	Current badge is not the one which has opened the session
KO_UnlockPlugInCharge	Plug unlocked during charge
KO_OnStreetOpenShutterInCharge	City only: Shutter is opened during the charge
Unplug error	
KO_ShutterNotClosed	Shutter is not closed at the end of charging session
KO_PlugStillDetected	Cable is not removed at the end of charging session
KO_EVStillDetected	Electric vehicle is still detected after end of charge request
KO_UnplugProcedureError	Other events

Report sub-tab

This sub-tab displays the maintenance report which describes the status of the charging station. The user can export this report as an .html file (**Export** button).

In case of unexpected event, export the maintenance report as an .html file after it. It will help the customer care center to identify the root cause.

Maintenance Report

Product Number

	Plug #102	Plug #103
Commercial Ref	EV.2S22P22R	EV.2S22P22R
Factory Code	FG	FG
Production Date	16302	16302
Production Revision	07	07
Batch Number	002	002
Unique Identifier	003	003
Product Id	502159V	502159V
Serial Number Part 1	3N170941686A2	3N170941686A1
Serial Number Part 2	S1B7551700014	S1B7551700014

Evse Status

Control sub-tab

Restart

Restart the charging station

Configuration

Back to factory configuration

The **Restart** button restarts the charging station after a change to a parameter for example.

The **Restore** button restores the factory settings of the charging station parameters.

Only RFID badges are kept. All other data, as CDR, are lost.

The button is accessible to the administrator only.

NOTE: During a Back to factory settings the current software version is kept.

Password sub-tab

Purpose of the password tab

- Modifying the password of the selected account.

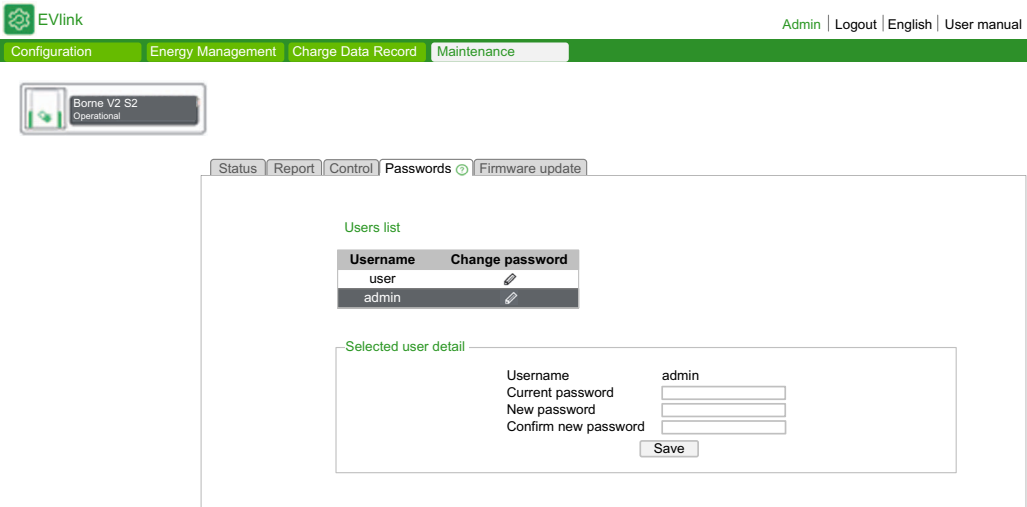

Action buttons in the list of users

Account	Button	Access rights		Action
		Admin	User	
User		R/W	N	Click the button to select the User account as the account to modify.
Admin		R/W	N	Click the button to select the Admin account as the account to modify.

Modifying the password of the selected account

Setting	Access rights		Description
	Admin	User	
Current password	R/W	R/W	Click in the field and enter the current password (hidden characters).
New password	R/W	R/W	Click in the field and enter the new password (hidden characters). The password must be minimum 12 characters, with at least 1 special character (@,\$,!,%,*,?,1), 1 uppercase, 1 lowercase, and 1 number.
Confirm new password	R/W	R/W	Click in the field and re-enter the new password to confirm it (hidden characters). Click Save to validate the password change.

Protecting access to charging station parameters and data

<i>NOTICE</i>
<p>Risk of incorrect parameter setting of the charging station and data violation</p> <ul style="list-style-type: none"> • When the charging station is commissioned, replace the default password with a password containing at least eight characters including upper-case, lower-case, numbers and special characters. • Ensure that only authorized personnel know the password. <p>Failure to follow these instructions can result in equipment damage or incorrect operation.</p>

In the event of loss of password

In the event that the password of the **User** account is lost, only the administrator can create a new one. If the password of the **Admin** account is lost, it is not possible to retrieve it or to create a new temporary password. The charging station must be restored to the factory settings using a manual procedure that does not require the use of the commissioning tool. Refer to document DOCA0117 or contact your Schneider Electric Customer Care to obtain this procedure for your charging station model.

NOTE: A restore to factory settings automatically erases all data contained in the charging station (Only RFID badges are kept).

Firmware Update sub-tab

Purpose of the Updates sub-tab

- Display the firmware version of the electronic board and the commissioning tool of each charge point. Each charge point is identified by the last byte in its IP address.
- Display the version of the RFID reader firmware when applicable.
- Upgrade the firmware.

Parameter list

Setting	Access rights		Description
	Admin	User	
Socket-outlet	R	N	Designation of the charge point. This is the last byte in the IP address of the electronic board of the charge point.
Electronic board	R	N	Firmware version of the electronic board of the charge point.
Commissioning tool	R	N	Firmware version of the commissioning tool of the charging station.
RFID reader	R	N	Software version of the RFID reader.

Downloading a software update

Updates are available for download from the Schneider Electric Web site with by searching “EVlink software”. They are in a compressed file in .zip format. The content and the update procedure are described in a release note added to the compressed file that should be read before proceeding with the update.



Appendix A Appendix

Maintenance report

Maintenance Report

Product Number

	Plug #102	Plug #103
Commercial Ref	EV.2S22P22R	EV.2S22P22R
Factory Code	FG	FG
Production Date	16302	16302
Production Revision	07	07
Batch Number	002	002
Unique Identifier	003	003
Product Id	502159V	502159V
Serial Number Part 1	3N170941686A2	3N170941686A1
Serial Number Part 2	S1B7551700014	S1B7551700014

Evse Status

	Plug #102	Plug #103
FW version	3300	3300
FW build number	4	4
Web version	3300	3300
Websserver build number	4	4
Boot Counter	17	17
CPW state	EVSE_Available_StateA	EV_Connected_StateB
Cable state	Not_Plugged	32A
EV state	A_Not_Present_12V	B_Present_9V
Last charge status	Not_Initialized	Not_Initialized
Evse Status	Normal Mode 3 Single-Phase	Normal Mode 3 Single-Phase
Outlet Status	OK_ChargeAuthorisationStarted	OK_ChargeAuthorisationStarted
Outlet Status Last Event	Not_Initialized	Not_Initialized

Event Status

bit description	Plug #102	Plug #103
Evt #1 - Rfid Reader	OK	OK
Evt #3 - Internal Communication	OK	OK
Evt #4 - Outlet Lock	OK	OK
Evt #5 - Contactor State	OK	OK
Evt #6 - Surge Arrestor	OK	OK
Evt #7 - Anti-intrusion	OK	OK
Evt #8 - Hardware Configuration	OK	OK
Evt #9 - Software Configuration	OK	OK
Evt #10 - Flap Sensor	OK	OK
Evt #11 - Upstream Protection Devices	OK	OK
Evt #12 - Power Meter Communication	OK	OK
Evt #13 - Remote Authentication Communication	OK	OK
Evt #14 - [Un]Plug Process	OK	OK
Evt #15 - Load tri-phasis compliancy	OK	OK
Evt #16 - Plc Communication	OK	OK

Evt #17 - Control Pilot (CP) Signal conformity	OK	OK
Evt #18 - Plug Presence (PP) conformity	OK	OK
Evt #19 - Charge Alarm EV Disconnected	OK	OK
Evt #20 - Charge Alarm ShortCut	OK	OK
Evt #21 - Charge Alarm OverLoad	OK	OK
Evt #22 - Charge Alarm Ventilation Not Allowed	OK	OK
Evt #24 - Modem Communication	OK	OK
Evt #29 - Remote EM Communication	OK	OK
Evt #30 - Supervision Communication	OK	OK
Evt #31 - NTP Server Communication	OK	OK

Latest events

Start Date	End Date	Plug	Event Code
Tue Jan 1 01:10:20 2013	Tue Jan 1 01:10:20 2013	2	10
Tue Jan 1 01:15:45 2013	Tue Jan 1 01:16:13 2013	2	3
Tue Jan 1 01:16:10 2013	Tue Jan 1 01:16:43 2013	1	7
Tue Jan 1 01:16:10 2013	Tue Jan 1 01:16:43 2013	2	7

Hardware Reference

	Plug #102	Plug #103
enveloppe	Monoblock	Monoblock
outletNumber	Socket-outlet 2	Socket-outlet 2
plugType	T2	T2
boardType	PBV2_1	PBV2_1
isAttachedCable	False	False
pushButton	Normal and stop	Normal and stop
lockType	Double lock	Double lock
lightIndicators	AVAILABILITY_AND_BOOKED_AND_OUT_OF_ORDER	AVAILABILITY_AND_BOOKED_AND_OUT_OF_ORDER
chargeIndicators	Load lamp only	Load lamp only
buzzer	KINGSTATE KPE-182	KINGSTATE KPE-182
modem	None	None
display	None	None
rfidReader	OSITRACK	OSITRACK

Io Model

	Plug #102	Plug #103
IoModel	Monoblock	Monoblock

Network

	Plug #102	Plug #103
Physical Address	00:80:F4:42:55:81	00:80:F4:42:55:80
Ip Address	192.168.0.102	192.168.0.103
Sub-Network Mask	255.255.255.0	255.255.255.0
Default Gateway	192.168.0.254	192.168.0.254
Prefered DNS Server	8.8.8.8	8.8.8.8
Other DNS Server	0.0.0.0	0.0.0.0
Modem Signal level	NC	NC

Message Logs

Plug #102		Plug #103	
Date	Message (Response code)	Date	Message (Response code)

Update Logs

Plug #102 :

Date	IPK	Status	Logs
Wed Jan 2 08:41:01 2013	r7_update_3.3.0.4_d2.epk	OK	1346 0 [INFO] Extracting /tmp/r7_update_3.3.0.4_d2.epk INFO /tmp/tmp.UGmTNR/
Mon Jan 7 15:42:07 2013	r6_update_3.2.0.12_d2.epk	OK	593 0 [INFO] Extracting /tmp/r6_update_3.2.0.12_d2.epk INFO /tmp/tmp.Gt6G1O/

Plug #103 :

Date	IPK	Status	Logs
Wed Jan 2 08:41:12 2013	r7_update_3.3.0.4_d2.epk	OK	1216 0 [INFO] Extracting /tmp/r7_update_3.3.0.4_d2.epk INFO /tmp/tmp.DkUWMe/
Mon Jan 7 15:42:17 2013	r6_update_3.2.0.12_d2.epk	OK	790 0 [INFO] Extracting /tmp/r6_update_3.2.0.12_d2.epk INFO /tmp/tmp.VTKAVh/

Configuration files

```
# Evse Conf

[FUNCTIONAL]
operatingMode-          2
clusterManagement-     0
simplifiedMode3-       true
ventilation-            false
localisation-           false
statePDelayPwmOff-     0
statePDelayPwmOn-      3
evChargeTimeout-       30
cpwRateStep-           0
isolatedInput1-        0
isolatedInput2-        0
diStatusExpected-     0x0060
diStatusEnable-       0x0268
autoTestEnable-       0x7FFFFFFF
SM3CurrentLowThreshold- 1
SM3MaxCurrent-         10
SM3StopDelay-          3600
postponeCharge-        false
allowPluggedCable-     false
enableEvDetection-     false
schukoWithNoDetectionEndOfCharge- 60
updateSetPointPeriodInSec- 15
remoteSetPointPeriodInSec- 5
stationNetworkType-    1
dhcp-                  0
strictDhcpMode-        0
slaveHasPublicIp-      1
stationName-           FG 16302 07 002 003
ssdp-                  1
dhcpMode-              0
loadSheddingSetPoint=0

[ENERGY]
voltageReference-      400
currentPH1-            32
nbPhase-               3
maxIntensitySocket-    32
maxIntensityStation-   64
maxTEValue-            14

HeadMeterType=5
HeadMeterProtocol=1
HeadMeterRTUAddress=1
HeadMeterGatewayAddress=130
HeadMeterPhase=1
StationMeterType=5
StationMeterProtocol=1
StationMeterRTUAddress=2
```

```

StationMeterPhase-2
AlternativeMeterType-5
AlternativeMeterProtocol-1
AlternativeMeterRTUAddress-3
AlternativeMeterGatewayAddress-130
AlternativeMeterPhase-3
MeteringPollingPeriod-1000
PowerMeterPhasesConnection-1
TerminalPhasesConnection-1
[HISTORY]
CurrentChargeLogPeriod-60

[HMI CONTROL]
EnableSuspendChargeByButton-false

[PROXY]
proxyEnabled- 0
proxyHost- UNDEFINED
proxyPort- 0
proxyAuthentication- 0
proxyUsername- UNDEFINED
proxyPassword- 2F94F0C34B68214E48D66C08D6893B2B
proxyUseHttps- 0
proxyUseHttpParam- 0

[TIME]
useAutoTimeManagement- false
timeServerName- pool.ntp.org
timezone- UTC

[EVLINK ENERGY]
pulseToEnergyFactor-1
degradedModeSetPointMono-8
degradedModeSetPointTri-14
monophasedLoadSheddingFloorValue-8
triphasedLoadSheddingFloorValue-14
EMsetting-1
upstreamProtHighTrshld-100
homeUpstreamProtection-32

[ENERGY SHARING]
staticMaxIntensityCluster-64
loadSheddingPriority-1
loadSheddingPeriod-900
phaseRotation-false

[ALTERNATIVE CHARGE]

[CURRENT MEASUREMENT]
currentAdjustementSlope- 722
currentAdjustementOffset- 0
lowOvercurrentTolerance- 10
mediumOvercurrentTolerance- 25
highOvercurrentTolerance- 70
lowOvercurrentDelay- 1010
mediumOvercurrentDelay- 5
highOvercurrentDelay- 1
iMaxStation- 64
overloadDelay- 90
overloadTolerance- 18

[AUTHENTICATION]
enableUnknownUser- true
authenticationManager- 0
rfidStatusTimeout- 10
masterkeyAvailability- false
authenticationMode- 1
supervisionSystem- 0
ControlChargeByRemoteCommand-false

# Ocpp Conf

[OCPP]
ocppVersion- 1.5
ocppCentralAddress-
ocppBoxLocalPort- 8080
ocppBoxPublicIp-
ocppBoxPublicPort- 8080
ocppBoxLocalSSL- 0
ocppBoxAddressReplyTo- http://www.w3.org/2005/08/addressing/anonymous
ocppModemIpAddress- 192.168.0.254
ocppModemPresence- 0
modemType-

```

```

boxIdentity-                UNDEFINED
defaultIdTag-              UNDEFINED
isMeterValueSimulated-    false
MeterValuesAlignedData-    Energy.Active.Import.Register
MeterValuesSampledData-    Energy.Active.Import.Register
meterValueSampleInterval-  900
clockAlignedDataInterval-  0
ocppConnectTimeOut-        60
WebSocketPingInterval-     120
MinimumStatusDuration-     0
TransactionMessageRetryInterval-60
TransactionMessageAttempts-500
truncateBootNotificationsSerialNumbers- false
serverCertificatePassword-UNDEFINED
clientHttpsOptions-        DEFAULT
cacheListEnabled-          false
enablePlugNumbering-       false
lastAcceptedOcppCentralAddress-
lastAcceptedBoxIdentity-
lastAcceptedHeartBeatInterval- 0
compressDiagnostic-        1
ocppEMDegradedModeEnabled- 0

# Report Conf

[REPORT GLOBAL]
GlobalLogReportPeriod-0
FieldSeparator-1
DecimalSeparator-1
PublicationProtocol-1
Language-en-gb

[REPORT CHARGE LOGS]
SmtplAuthentication-true
SmtplLogin-testEV@gmail.com
SmtplPassword-61F311D351BD56CBF3EAFD03147D31D16A2C67092F16CF51EDEBE1199AE342E0
SmtplSender-testEV@gmail.com
SmtplServer-smtp://smtp.gmail.com
SmtplPort-587
SmtplLogsReceiver-customer@group.com

[REPORT ALARM]
AlarmEnabled-true
AlarmAuthent-true
AlarmLogin-EV.2S22P22RFG1630207002003502159V
AlarmPassword-DEDDFDB60EBDD721BE599B83ABBADE91D2B8DED9F96B49824D61C20EA3B23462D1281C687456D8341CDD6389BAAB8AAC2
AlarmSender-service@wallboxmail.com
AlarmServer-
AlarmPort-587
AlarmReceiver-

[REPORT FTP]
FtpAuthent-false
FtpLogin-
FtpPassword-2F94F0C34B68214E48D66C08D6893B2B
FtpServer-
FtpPort-21
FtpPassif-0

[REPORT HTTP]
HttpAuthent-false
HttpLogin-
HttpPassword-2F94F0C34B68214E48D66C08D6893B2B
HttpServer-
HttpPort-80
HttpPath-/
HttpField-

[REPORT HTTPS]
HttpsAuthent-0
HttpsLogin-
HttpsPassword-2F94F0C34B68214E48D66C08D6893B2B
HttpsServer-
HttpsPort-80
HttpsPath-/
HttpsField-

[SMTP]
authentication-true
login-testEV@gmail.com
password-61F311D351BD56CBF3EAFD03147D31D16A2C67092F16CF51EDEBE1199AE342E0
sender-testEV@gmail.com
server-smtp://smtp.gmail.com
port-587
receiver-"customer@group.com"

[WIFI]

```

```
# Update Conf
[UPDATE GLOBAL]
GlobalFWUpdateProtocol-0
DefaultPackageName-evse

[UPDATE HTTP]
HttpLogin-
HttpPassword-2F94F0C34B68214E48D66C08D6893B2B
HttpServerAddr-192.168.0.101
HttpPort-80
HttpPath-

[UPDATE FTP]
FtpLogin-
FtpPassword-2F94F0C34B68214E48D66C08D6893B2B
FtpServerAddr-
FtpPort-21
FtpPath-

[UPDATE TFTP]
TftpServerAddr-
TftpPath-
```

Report created on : Tue Jan 2 07:45:10 2013

End of document.



DOCA0060EN-10

Schneider Electric Industries SAS

35, rue Joseph Monier
CS30323
F - 92506 Rueil Malmaison Cedex

<https://www.se.com>

As standards, specifications and designs change from time to time, please ask for confirmation of the information given in this publication.

03/2022