



Vehicle and Person Detection Sensor

ITS-AX4

User Manual

Please carefully read this manual before installation.



Content

Introduction	2
Features	3
Dimensions	4
Installation Instructions Barriers	5
Installation Instructions Doors, Gates	6
Mounting process	7
Cable interface definition	8
App Details and download	9
Configuration Instructions	10
Mode 1 - Anti collision	13
Mode 2 - Triggering	18
Live Sensor status	25
Advanced Settings	26
Remarks	27
Common problems	28

Introduction

The Vehicle and person detection sensor ITS-AX4 is designed for the entrance and exit management of parking lot or underground garage. It can be used as barrier arm anti-collision sensor or trigger sensor which can precisely control the open & close of the barrier arm by cooperating with the gate main control board, the sensor detection area can be configured by mobile App via bluetooth, compared with traditional loop detectors, it's much more convenient and smarter, meanwhile no need any saw cuts. which greatly improve customer experience with its excellent performance and competitive cost.

The sensor is millimeter wave technology radar sensor with the highly integrated RF chip SOC scheme, which has the characteristics of small size, low cost, all-weather working capability, high detection, sensitivity, high precision, easy debug&installation, very good stability and reliability. It is a new type detector which can be perfect alternative of loop detectors.

The sensor antenna is MIMO design that enables the sensor good angular resolution and high angle measuring accuracy. The signal processing and control unit apply DSP+ ARM dual core architecture. Through the combined optimization design of software and hard-ware, this product can accurately identify and judge the targets passing through the barrier arm area, and avoid the accident of "vehicle or person hurt " and "barrier not closed".



Features

LED indicators

Two LED indicators on the front of sensor.

Red LED is for power, it will stay on when power on.

Green LED is for signal, it will stay on when objects detected in the detect area and turns off when there is no objects.

Detection area configuration

anti collision mode sensor default detection length is 3m in front and 0.5m left & right side. trigger mode sensor default detection length is 1.9m in front and 0.5m left & right side. different detection areas can be configured via mobile APP or laptop debugging software.

Configuration parameters saving and reload

Configuration such as detection area can be automatically saved, and the latest configuration parameters will be loaded after sensor power off and restart.

Firmware upgrade

The firmware can be upgraded online through App or RS-485 no need to dismantle the sensor, and the new firmware will be effective just by restarting the sensor power.

Stable performance

millimeter wave technology is strong and work perfectly in harsh environments such as different light conditions, rain, fog, snow & dust.

Dimensions

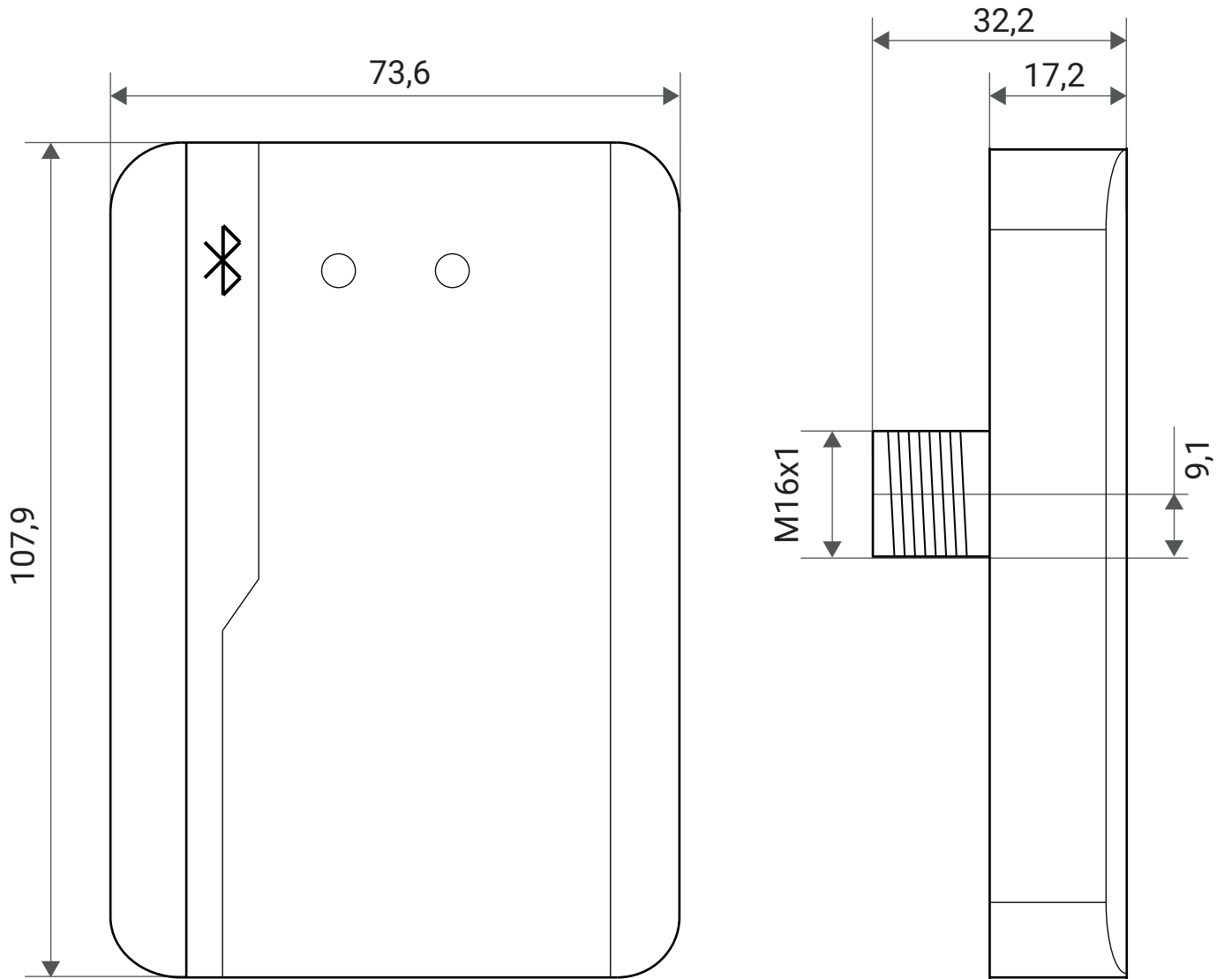

Installation Instructions for Barrier

Drill a 18mm hole on the barrier control box cover to install the sensor, follow the size before drilling



65 - 75 cm
Small cars and van trucks

75 - 80 cm
Chassis higher than 70cm like large Trucks

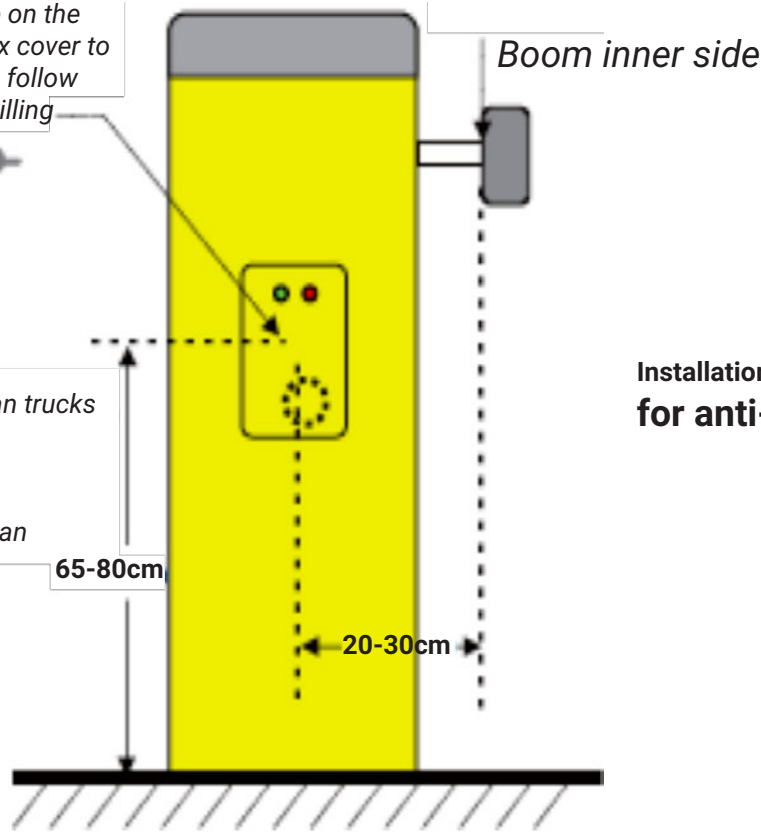

Installation position
for anti-fall use

Installation position
for trigger mode

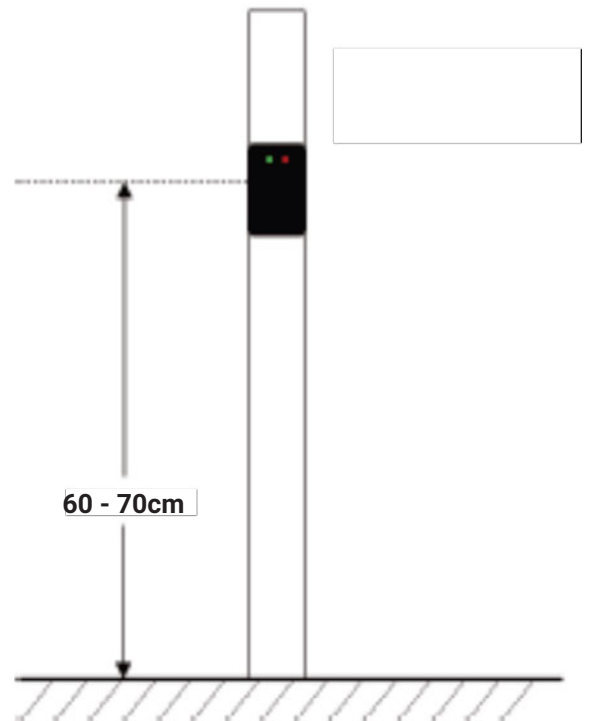

IMPORTANT

The detection field of the radar should be seen as an inflated balloon.

To ensure the correct functioning of the AX4 radar, the radar must be mounted

- in an open surface

- the radar sensor must be mounted at least 80 cm from every wall - fence - gate - ceiling etc...

Installation Instructions for Doors

For applications with doors and gates use the optional mounting set **ITS-Mount** for easy alignment of the sensor.

Additionally, 5m and 10m long connection cables are available.



ITS-Mount
Easy Mounting bracket

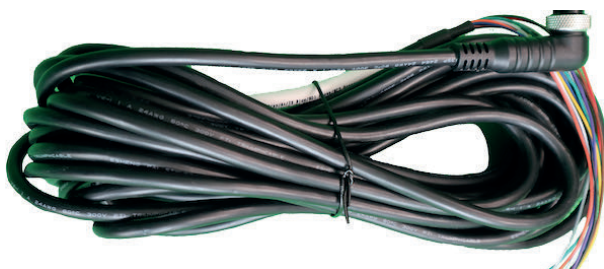

ITS-Cable5
Connection cable 5m

ITS-Cable10
Connection cable 10m

Mounting process

To guarantee the function, be sure to mount the sensor exactly as described. Please use the material supplied for this purpose.

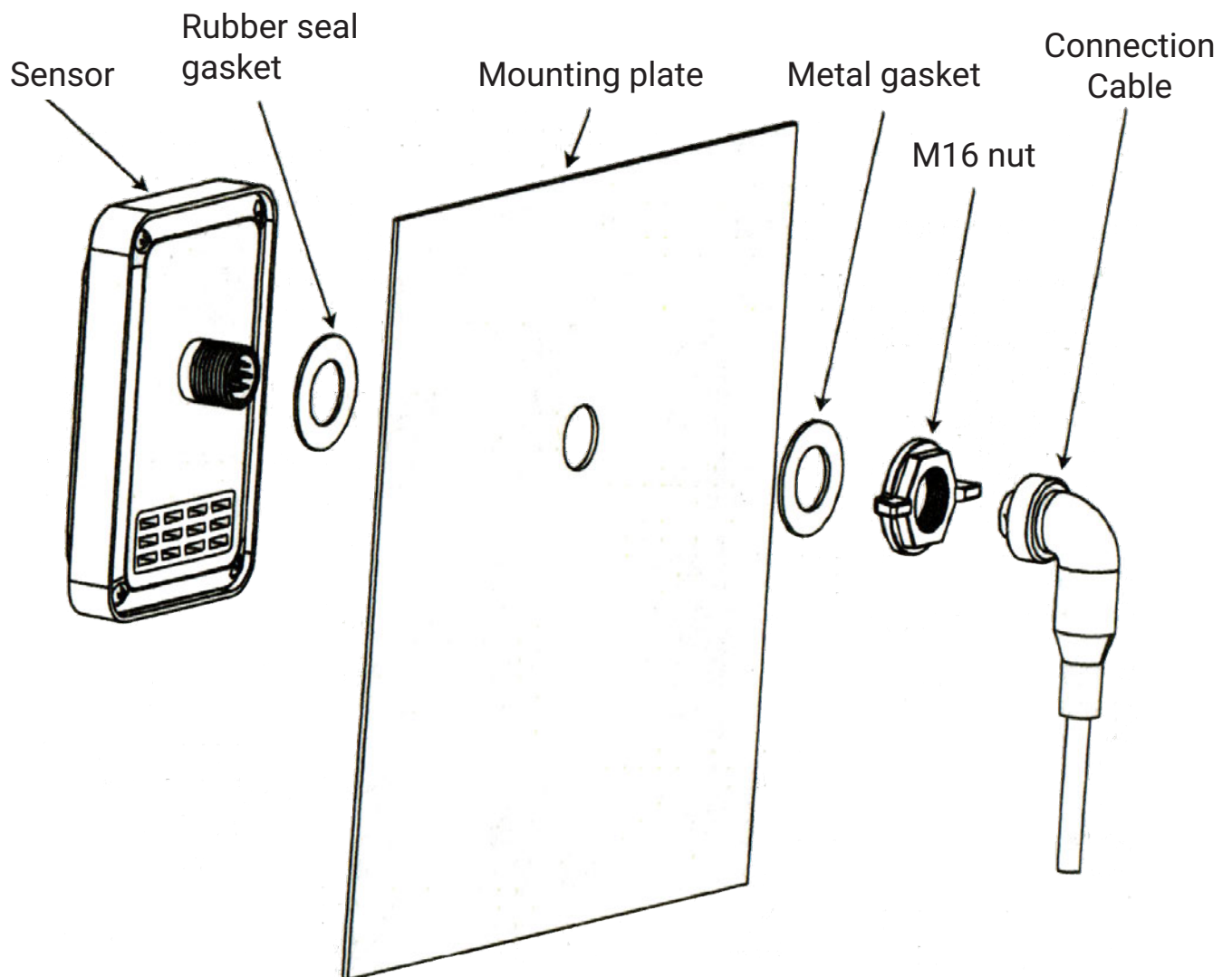

Cable Interface Definition

ID	Color	Description
9-24V	Red	+
GND	Black	-
B- / RX	White	RS485 B-
A+ / TX	Grey	RS485 A+
NO 1	Blue	NO 1
NO 1	Green	NO 1
NC 2	Brown	NC 2
NC 2	Purple	NC 2
INPUT	Orange	Spare
GND	Yellow	Spare

NO Output type

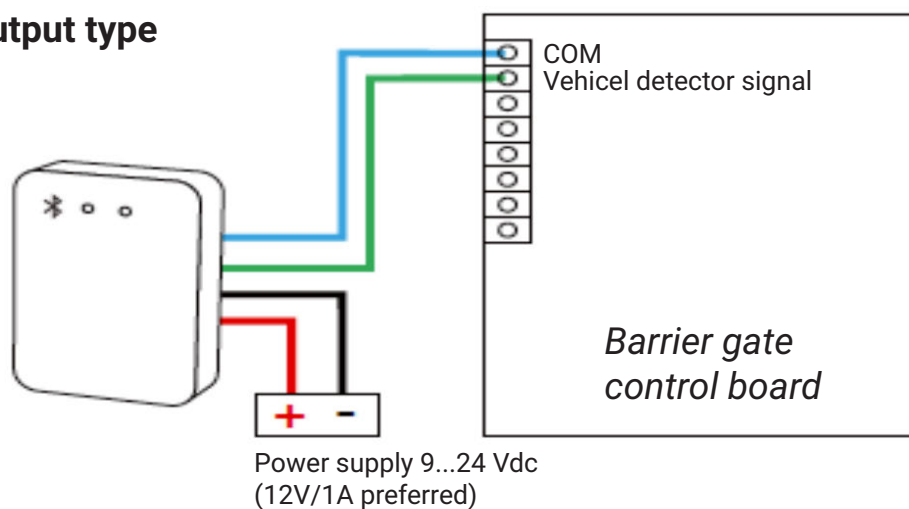

NC output type

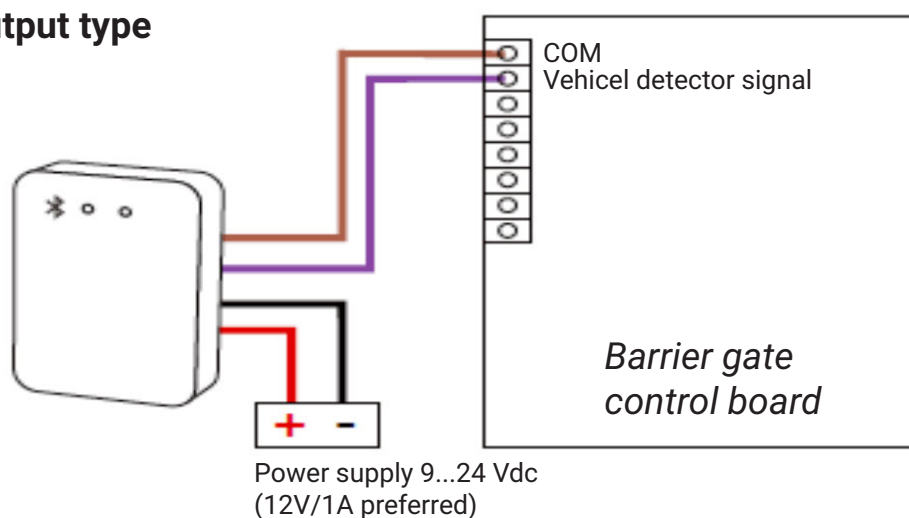

App Details and download

Download

The **ISensor** app can be downloaded free of charge from the Apple Store and the Google Play Store.



ISensor App

Password

User Password: 88888888 (*8 times an 8*)

Password can be changed with other 8 digits, only numbers can be used

Configuration Instructions

Mobile App configuration

1. Download the App to the mobile phone and open it. (Figure 2)
2. Click the „Connect device“ Button.
3. Select the right Radar Sensor (Figure 3)

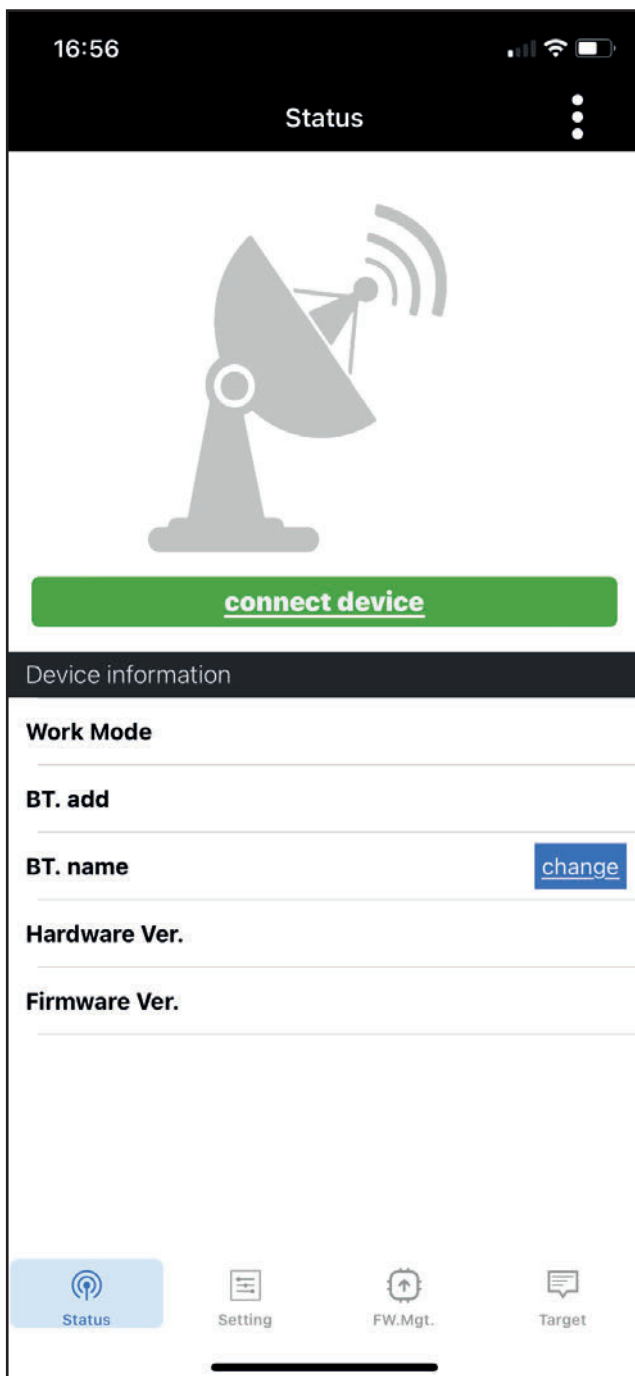

Figure 2

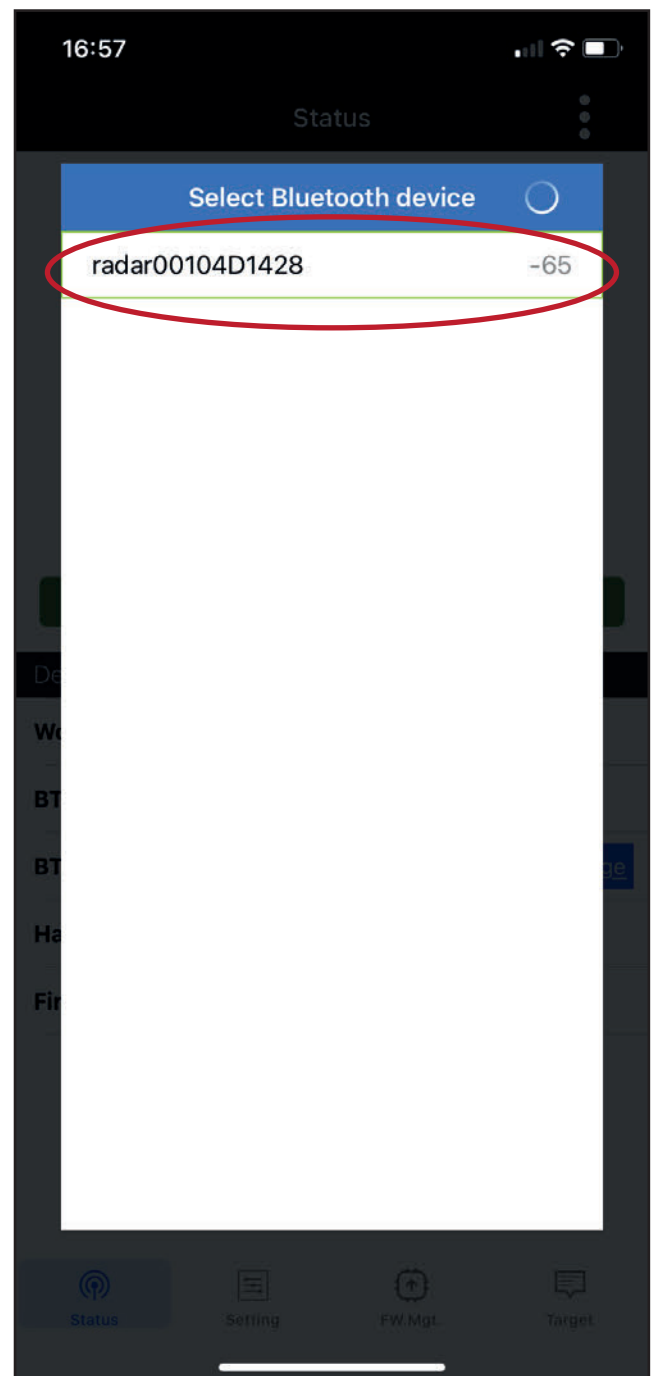

Figure 3

4. Enter the password (Figure 4)
Standard Password is 88888888 >>Please change standard password
5. Choose the mode you need for your application (Figure 5)

Anti-Collision = Anti Fall Protection for automatic barriers

Trigger Mode = as detector for opening or closing an automatic barrier or gate.

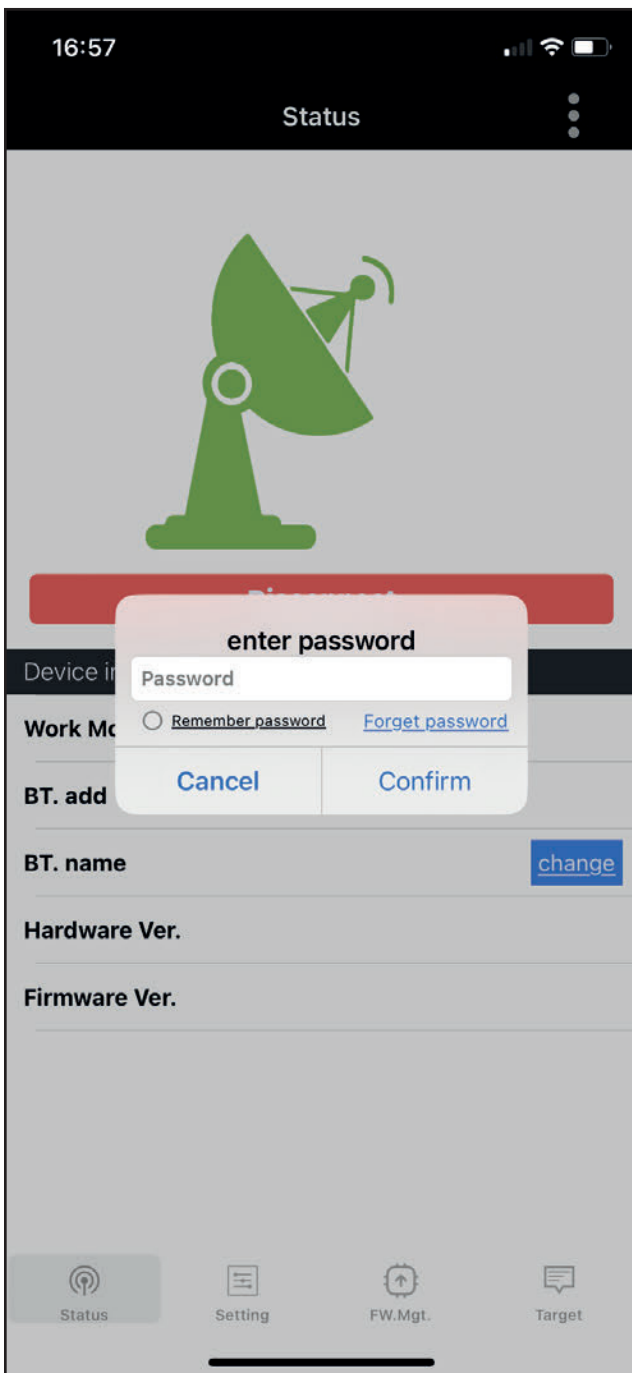

Figure 4

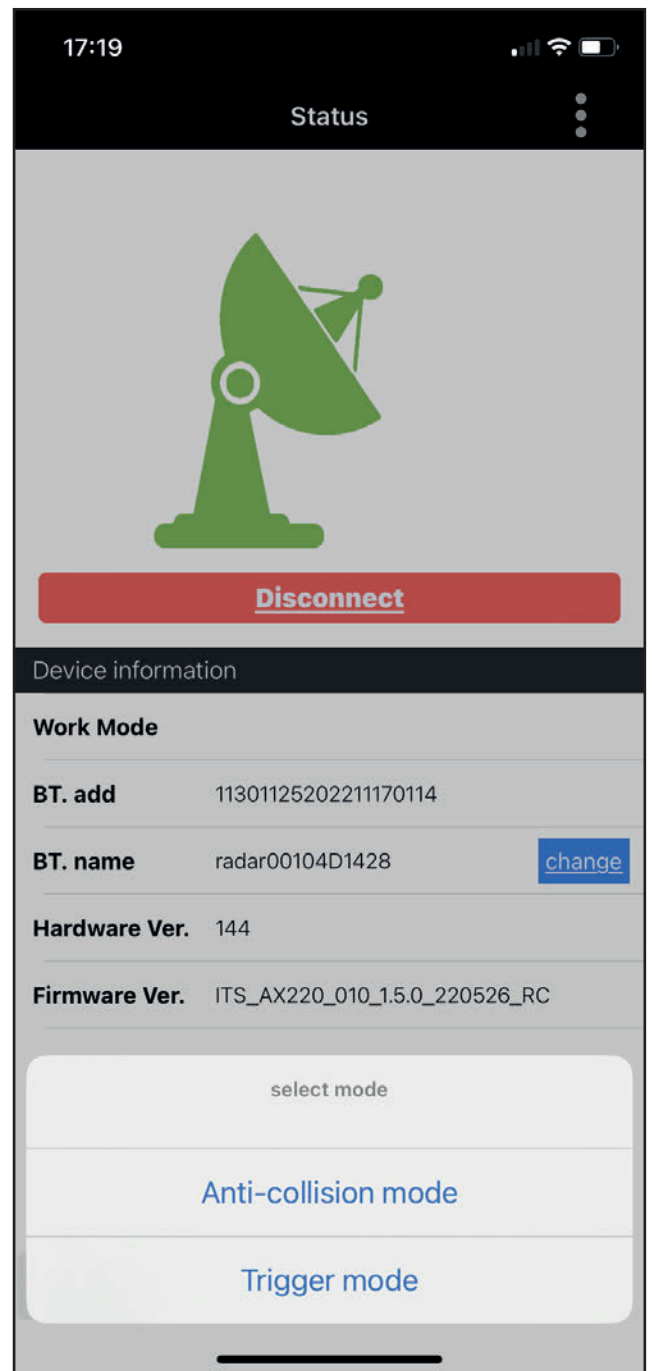

Figure 5

6. Now you are connected to the sensor. (Figure 6)

Here you also can change the name of the sensor by clicking on „change“
Use a clear and unique name for the sensor for a better identification.

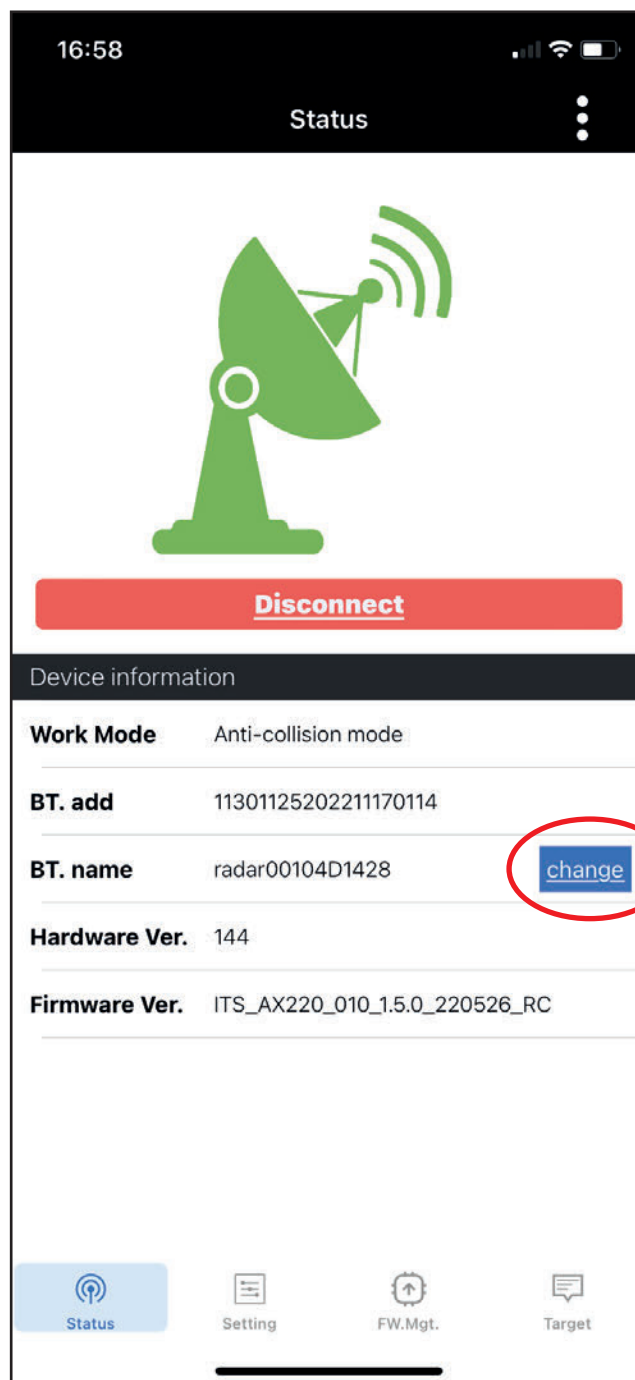
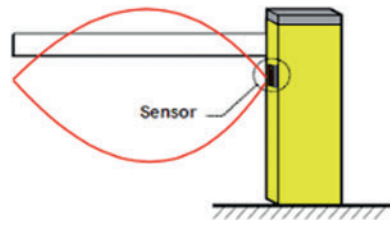

Figure 6

Mode 1 - Anti collision



Anti-collision = anti-fall = under protection by the automatic barrier to ensure that the barrier does not fall on a person or a vehicle/truck.

1. Press „Select“ and choose your preferred barrier type an „Confirm“ (Figure 7 & 8)

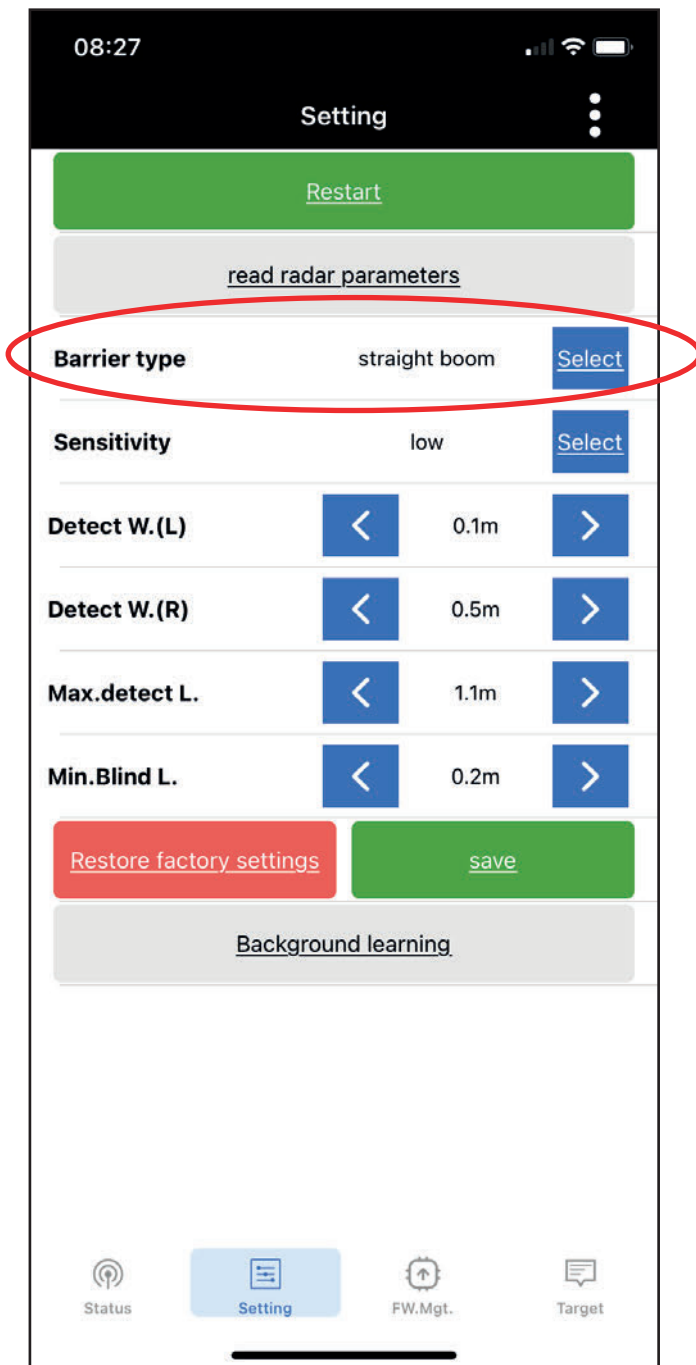

Figure 7

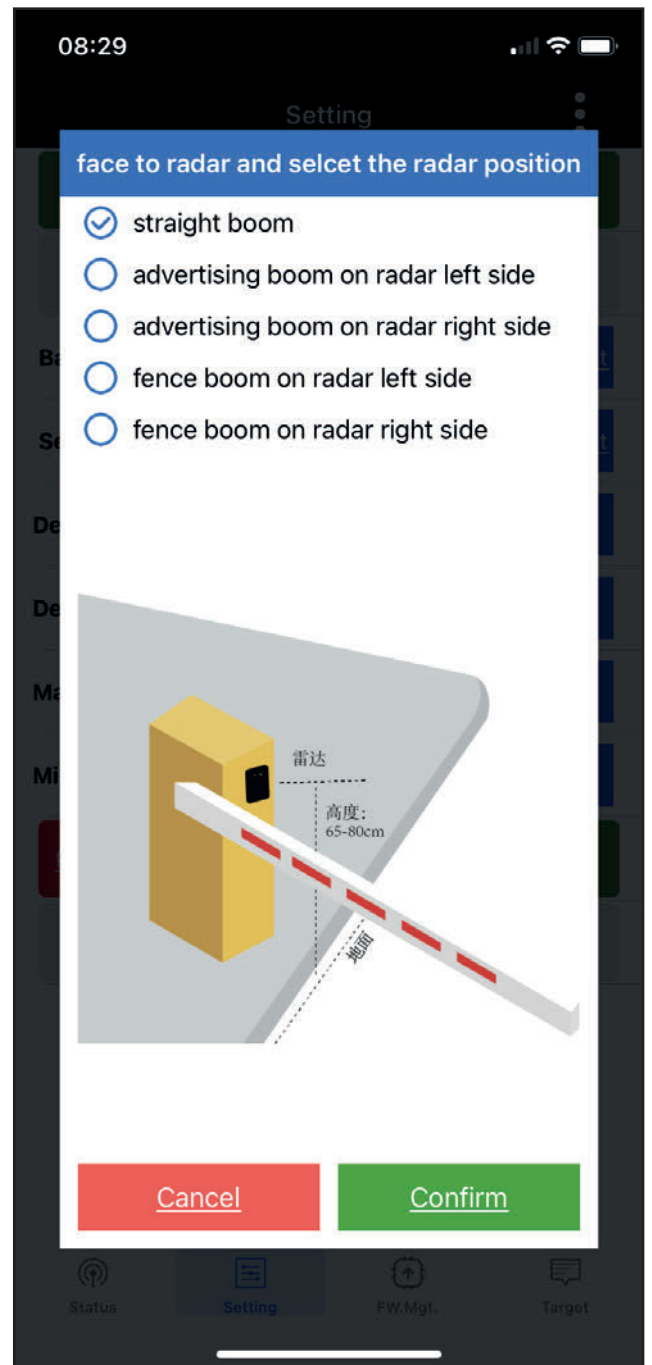

Figure 8

2. Decide what you want to detect, press „Select“ at Sensitivity and „Confirm“

High: Persons and vehicles
Low: Vehicles only

(Figure 9 & 10)

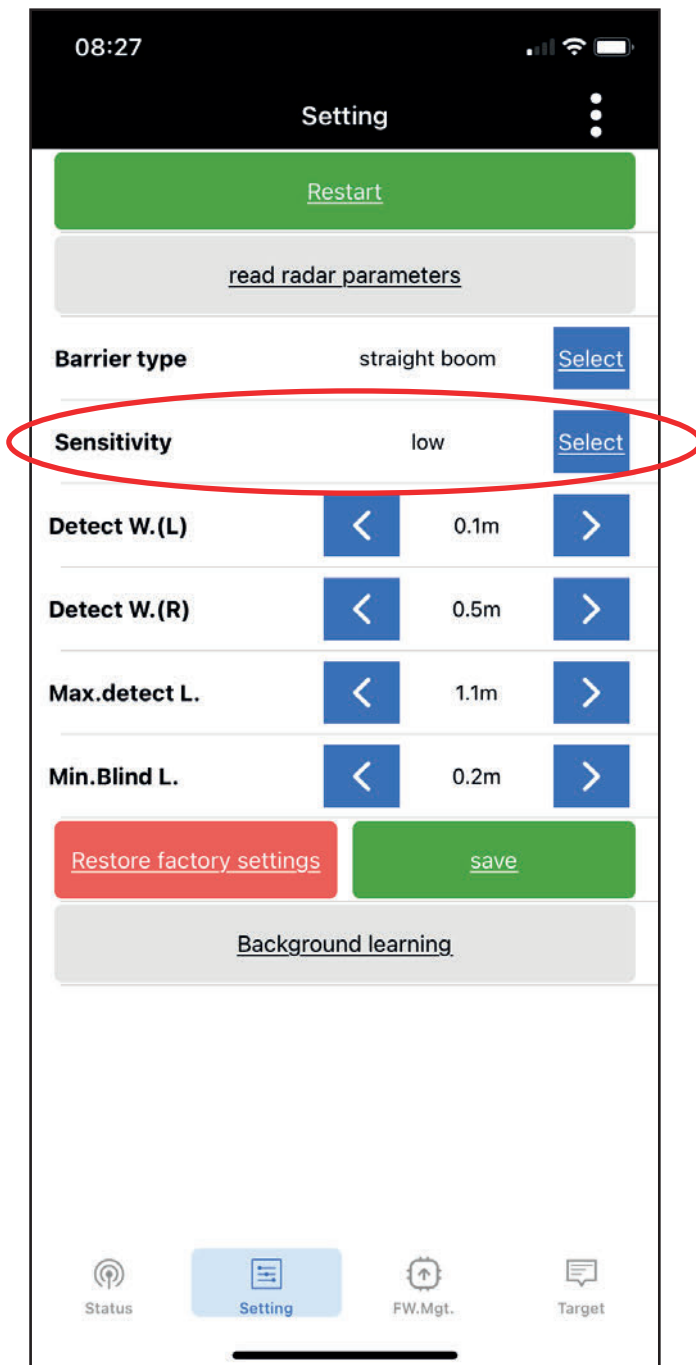

Figure 9

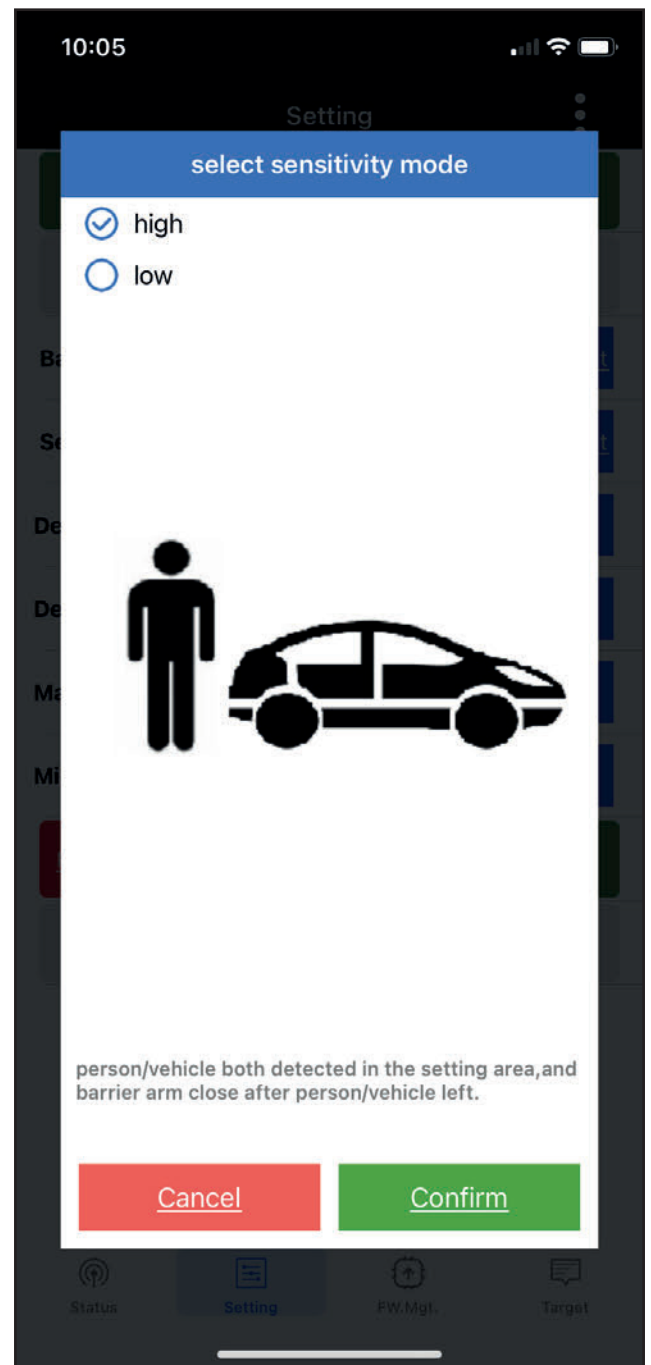

Figure 10

3. Choose the desired detection field and press „Save“
(Figure 11)

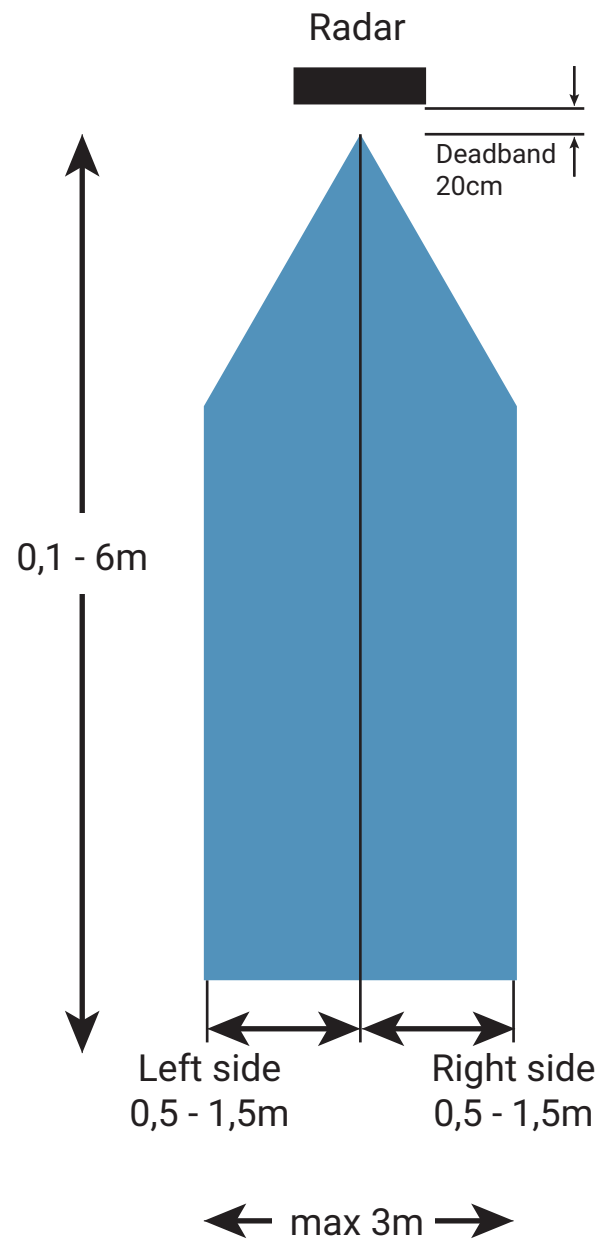
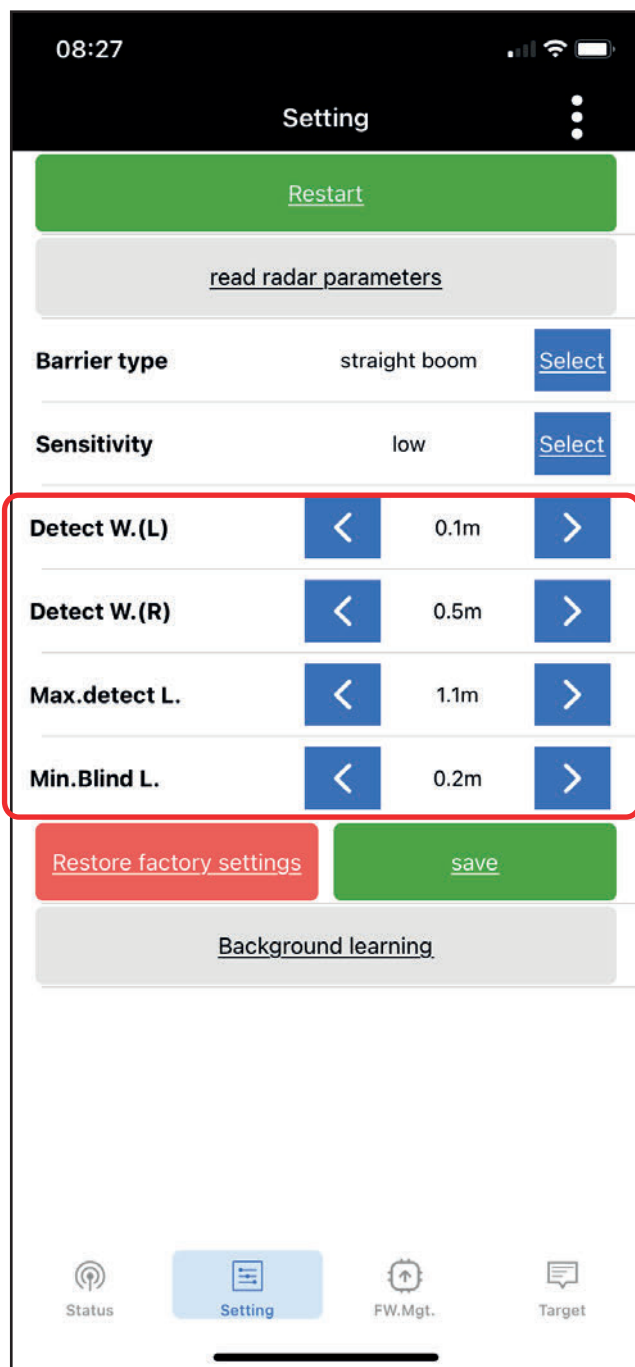

Figure 11

4. Now teach the background to the sensor by pressing „Background learning“

IMPORTANT

- Automatic barrier must be open - barrier up!
- No object may be present in the detection field

(Figure 12)

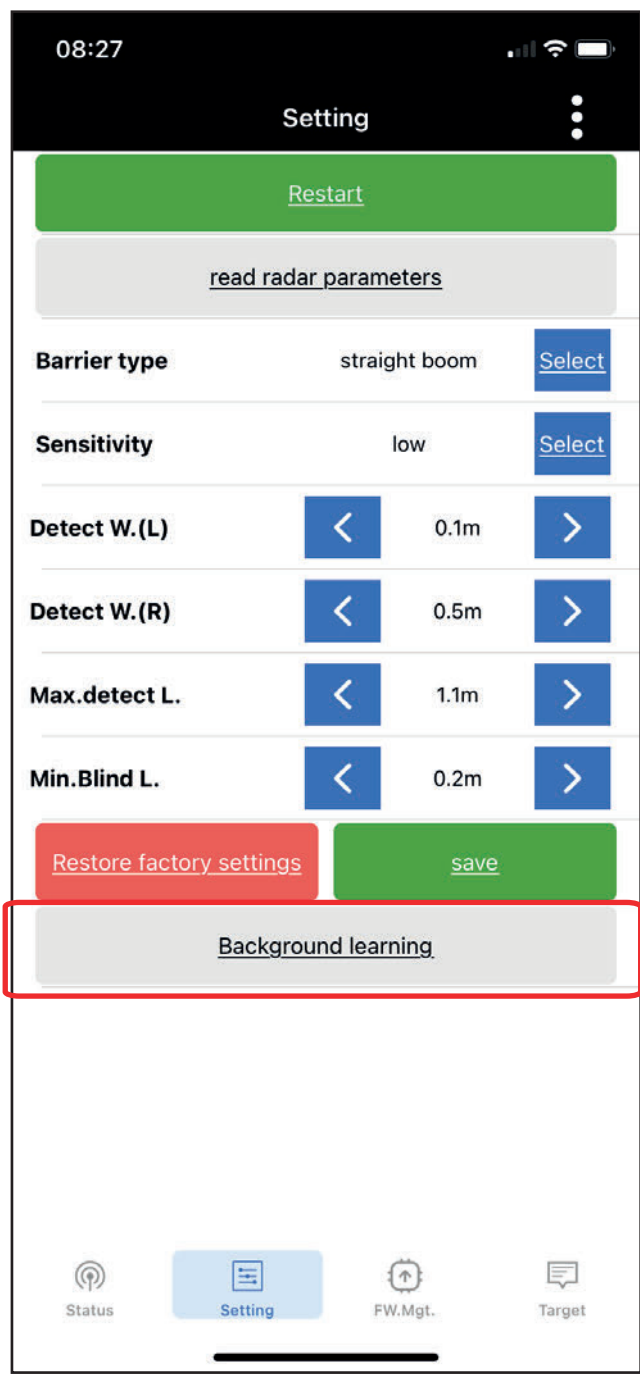
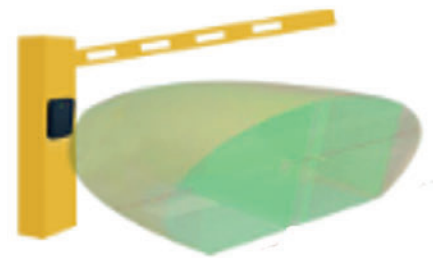

Figure 12

Please note the following information when fitting the AX4 radar:

The detection field of the radar should be seen as an inflated balloon.
To ensure the correct functioning of the AX4 radar, the radar must be mounted

- in an open surface
- the radar sensor must be mounted at least 80 cm from every wall - fence - gate - ceiling etc...



Mode 2 - Triggering

Triggering = as a detector without reflector for opening or closing of automatic barrier or industrial gates. Is also an alternative for inductive loops or infrared photocells. Present detection of trucks in dock stations.

1. Decide what you want to detect, press „Select“ at Sensitivity and „Confirm“

High: Persons and vehicles Low: Vehicles only

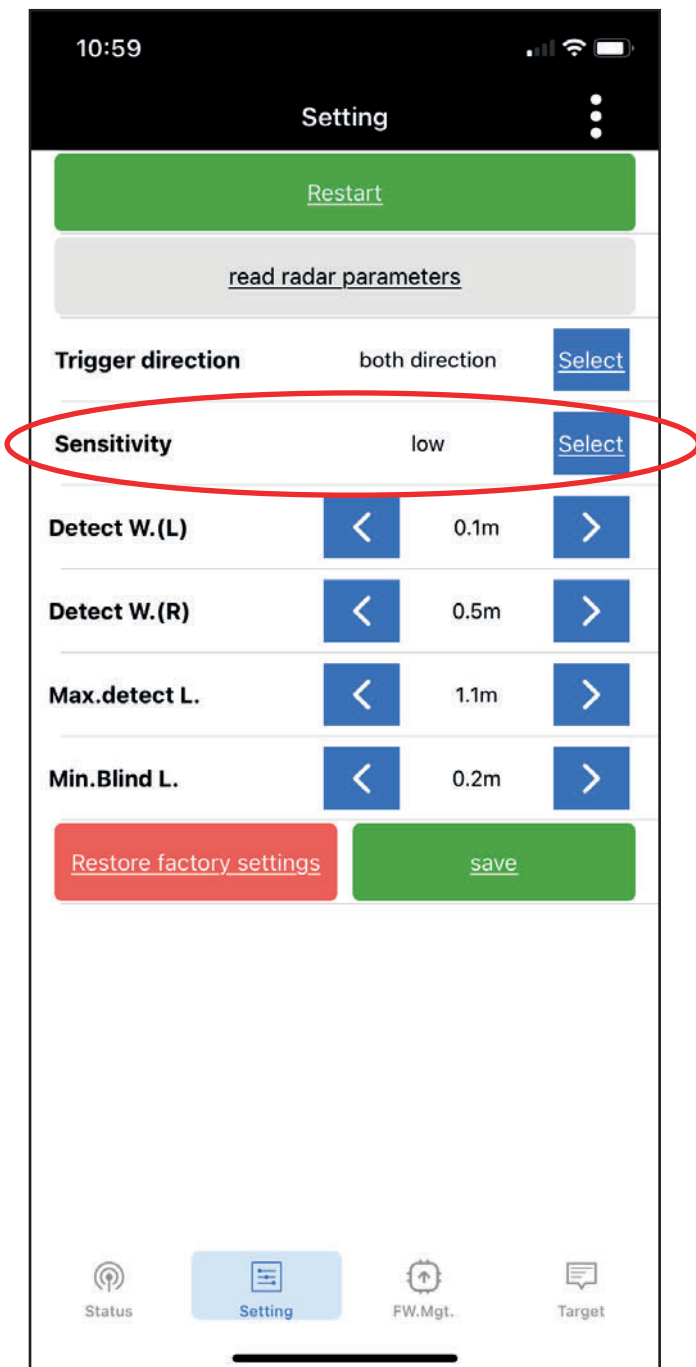

Figure 13

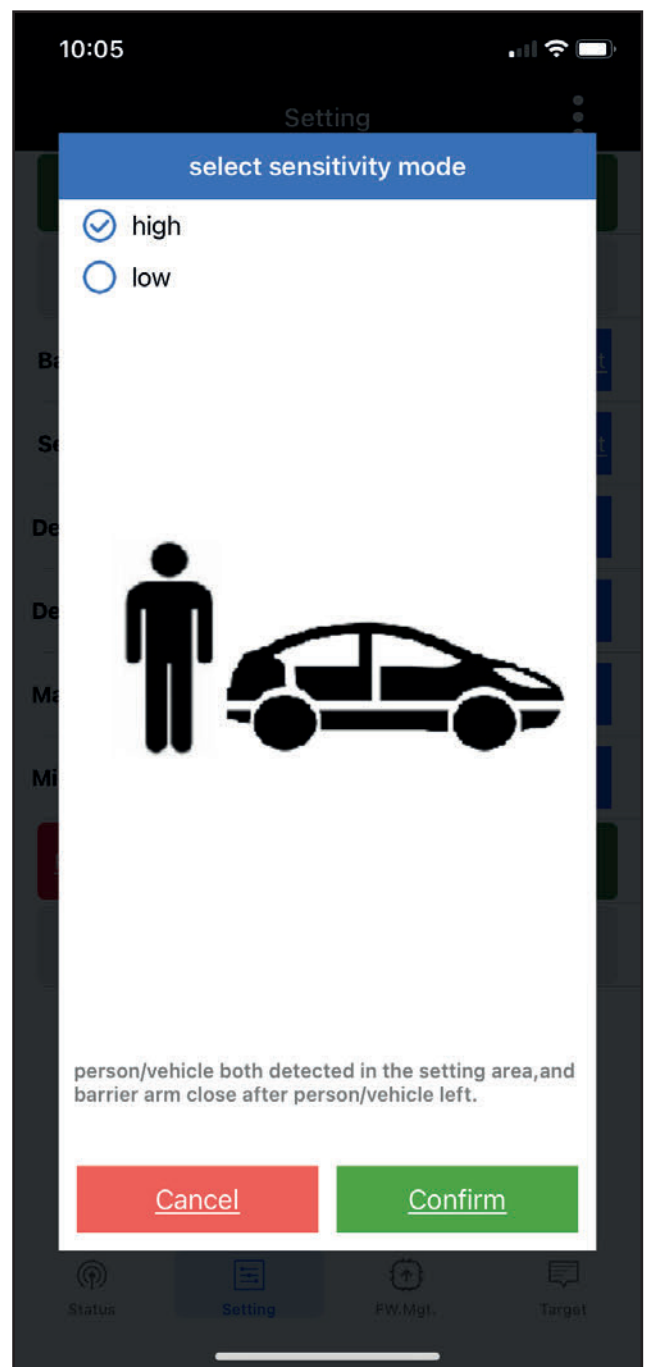

Figure 14

2. Make a selection regarding detection direction: Position you in the front of the radar AX4 and press „Select“ and make your choice:

- both(all) directions
- left to right
- from right to left

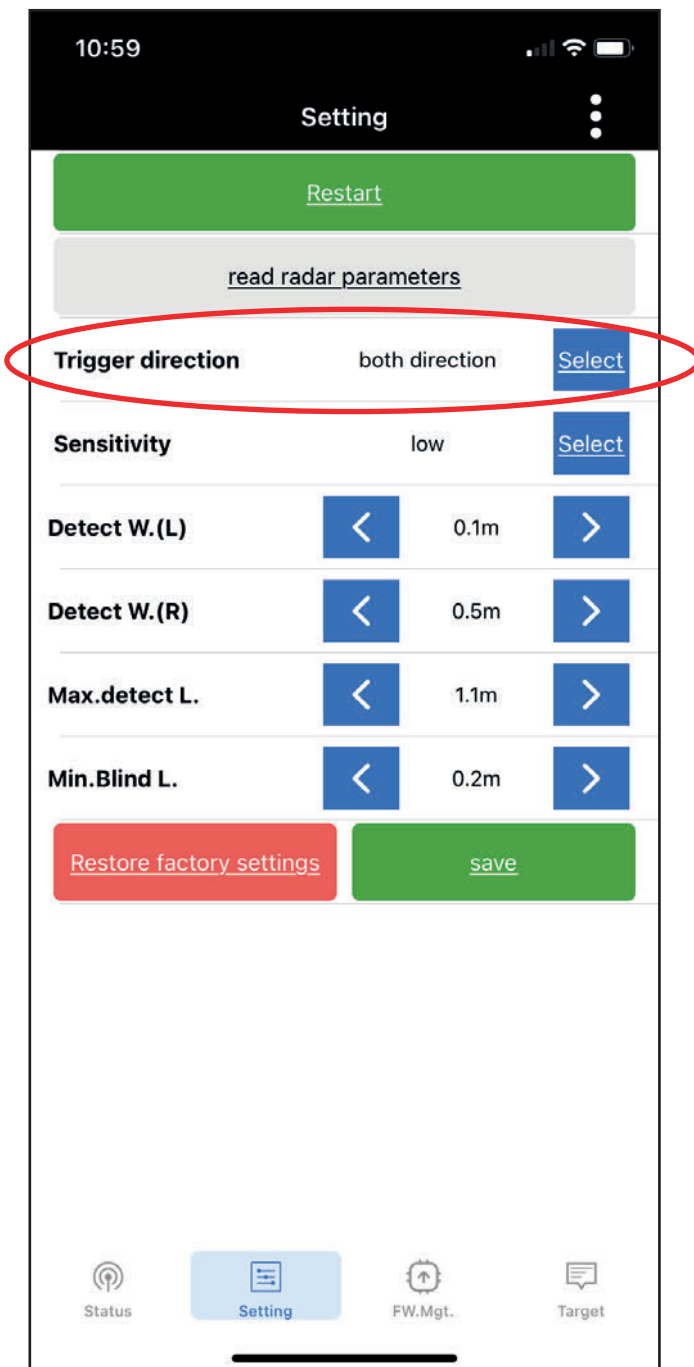

Figure 15

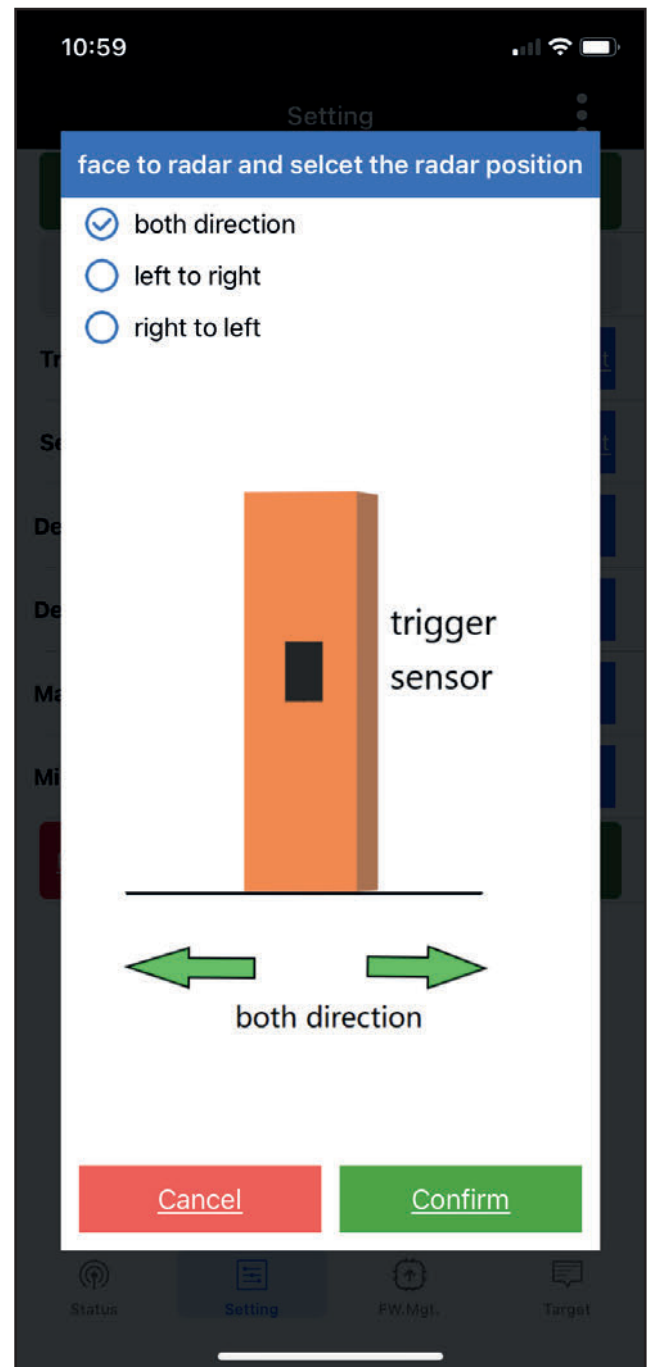

Figure 16

3. Choose the desired detection field and press „Save“
(Figure 11)

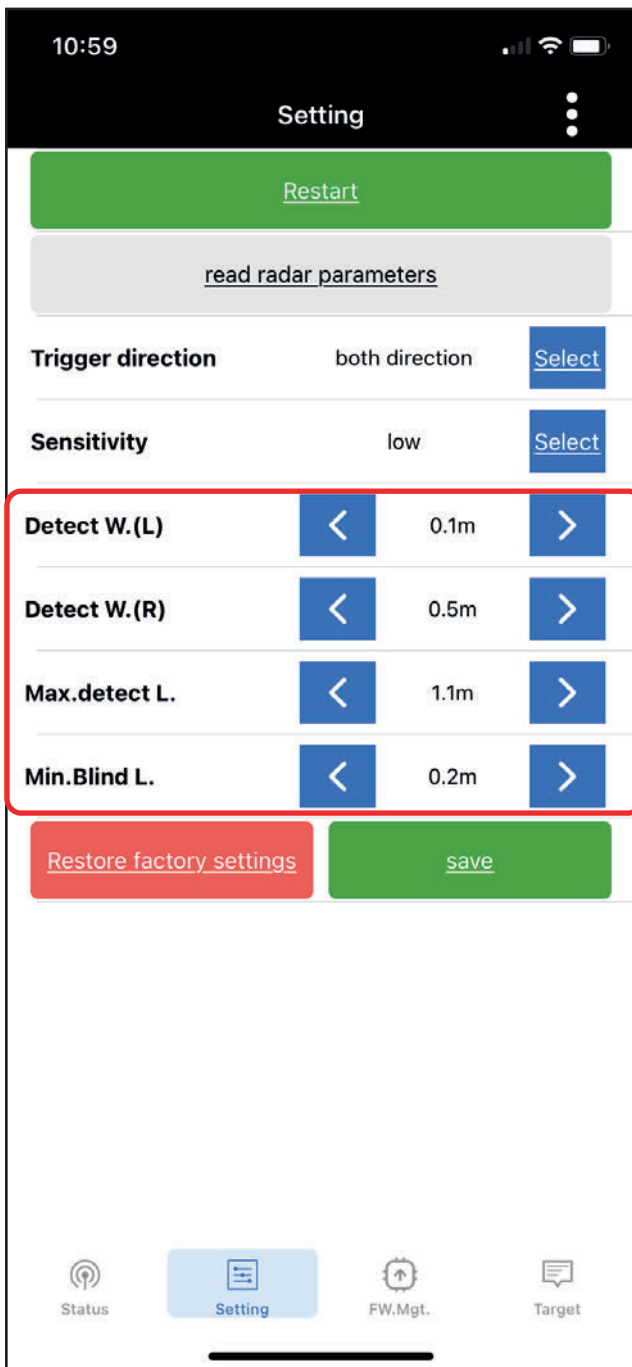
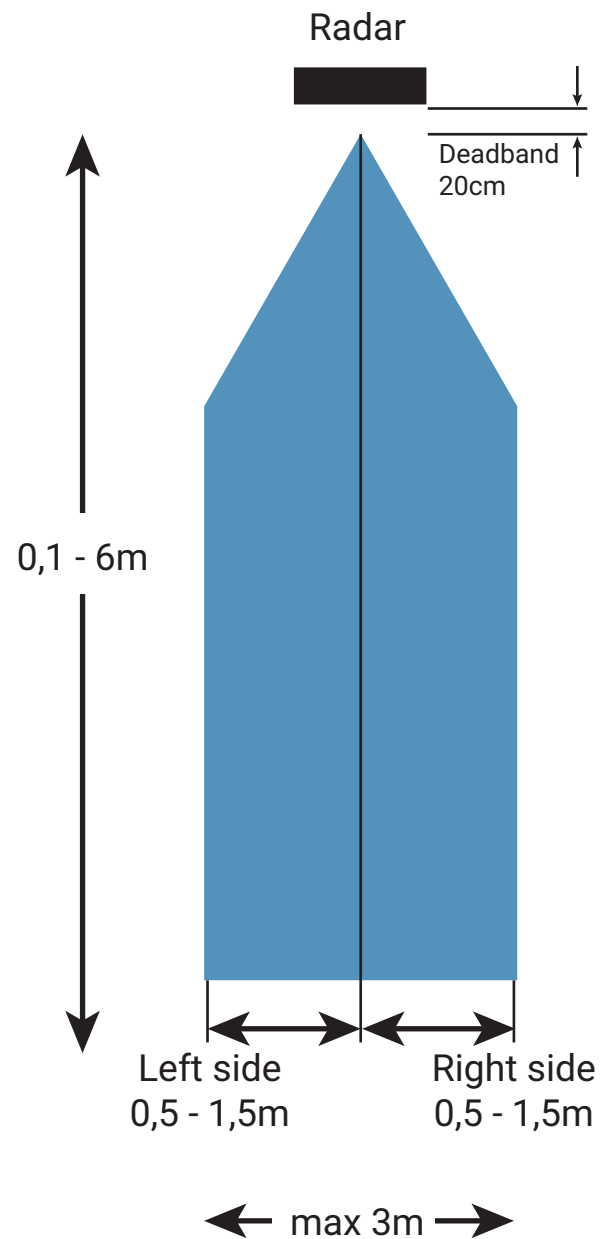

Figure 17



Please note the following information when fitting the AX4 radar:

The detection field of the radar should be seen as an inflated balloon.
To ensure the correct functioning of the AX4 radar, the radar must be mounted

- in an open surface
- the radar sensor must be mounted at least 80 cm from every wall - fence - gate - ceiling etc...

***For open and closing automatic barrier – replacing inductive loops**

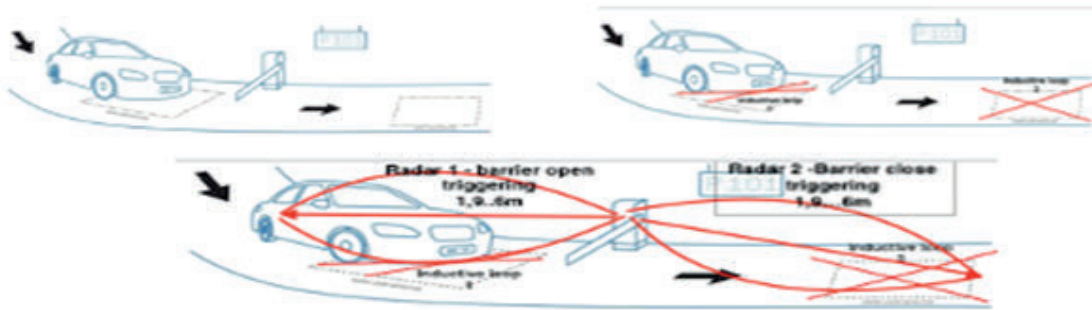

***For triggering a plate recognition camera's**



***For car counting in your parking:**

Effective Car Counting is one of the best ways to maximize revenue your parking

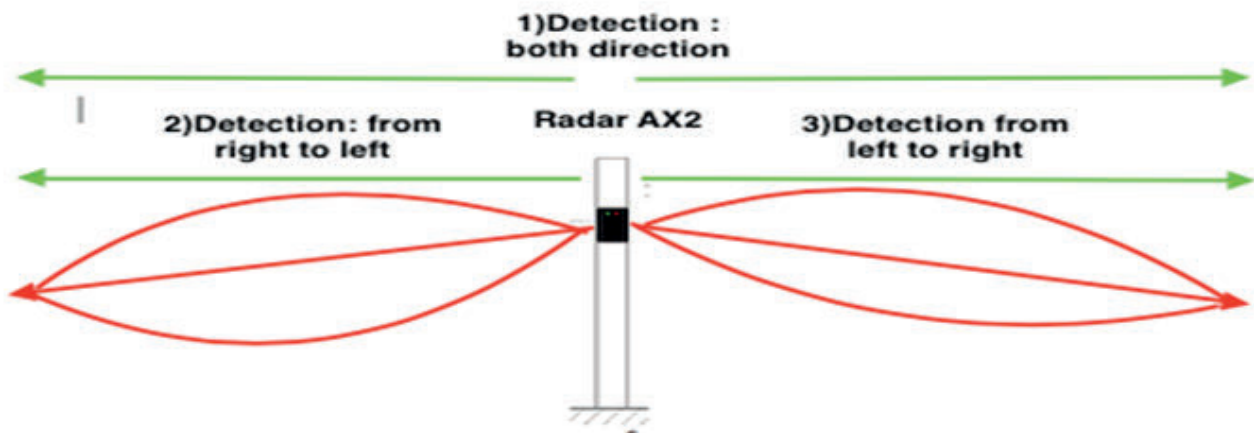

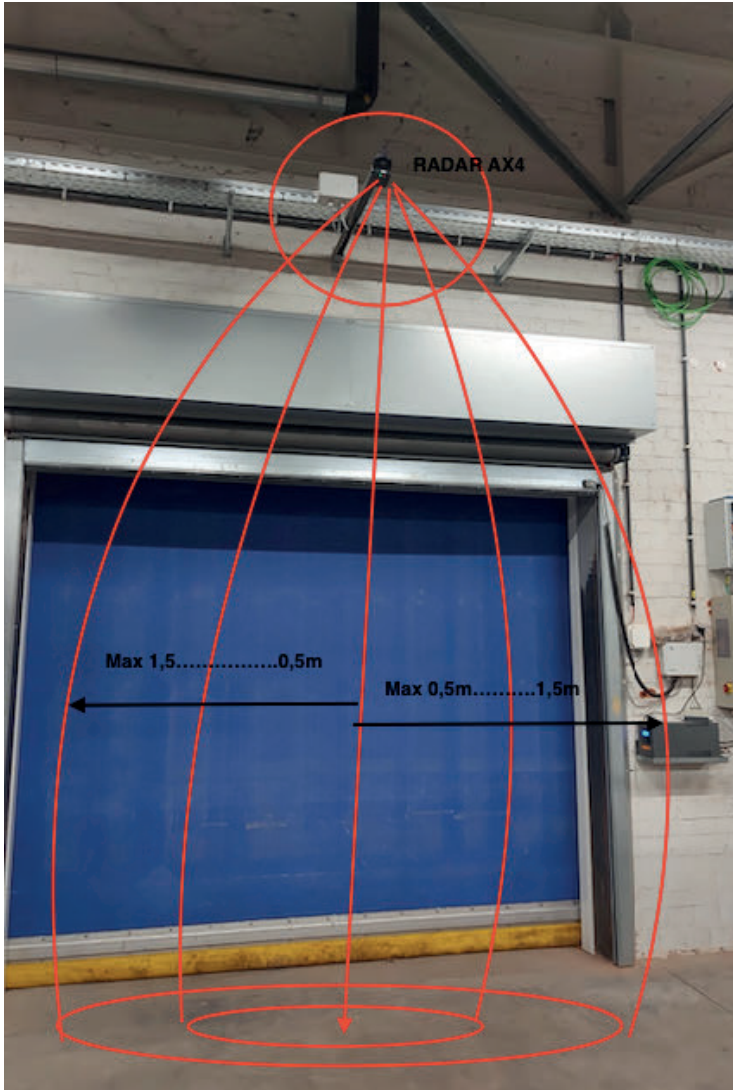

Alternative for inductive loops/photocells: contactless open-close detection

Example: Speed gates in very low t° - cool rooms – open and closing speed gates

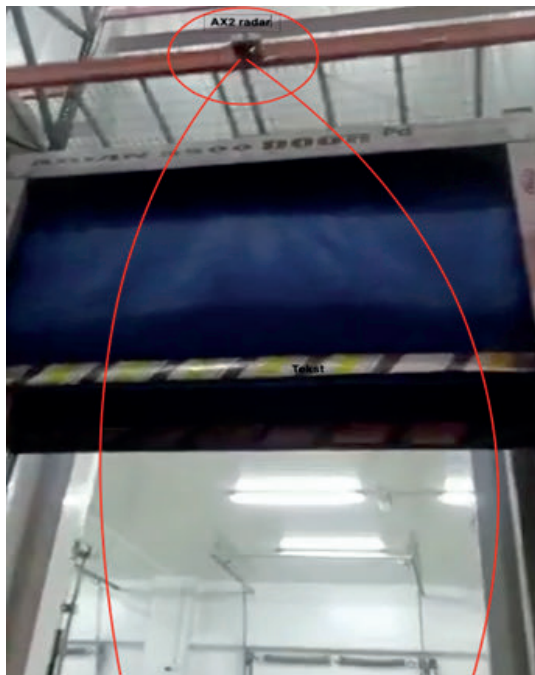



As an alternative to mechanical pull cords – replacing “Pull-string” door opening

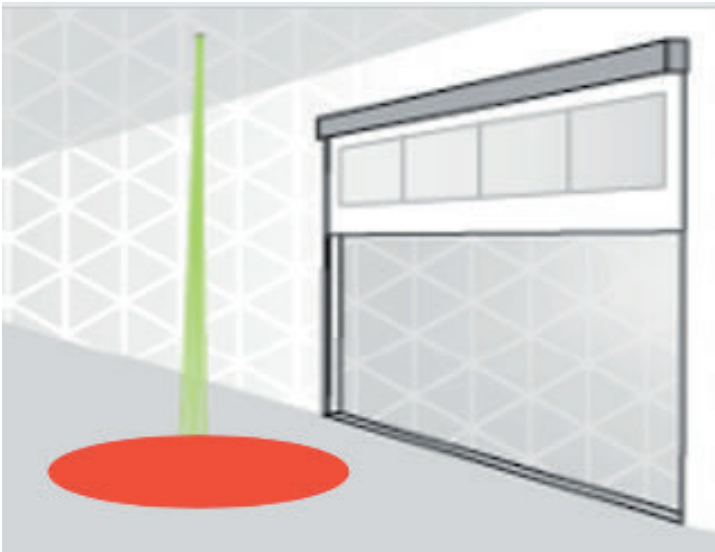



Monitoring arrival and departures of trucks at a loading outdoor dock station.



Electrical vehicle detection at charging stations.

Live Sensor Status

Use „Target“ for actual sensing details from the sensor. This mode helps enormously when setting up the sensor.

Be patient, it may take a moment until the signals are transmitted.

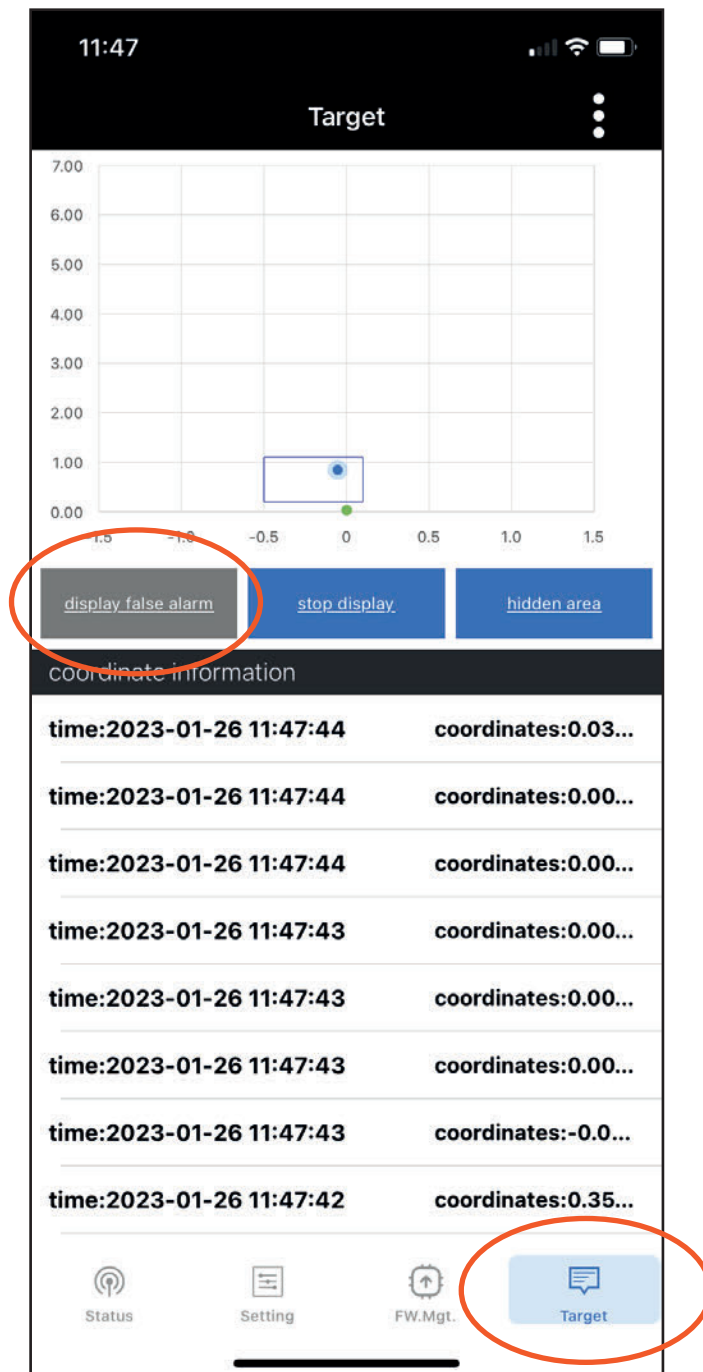

Figure 18

Advanced Settings

Other functions can be seen in up right corner, such as switching delays, password change, updates etc.



Figure 19

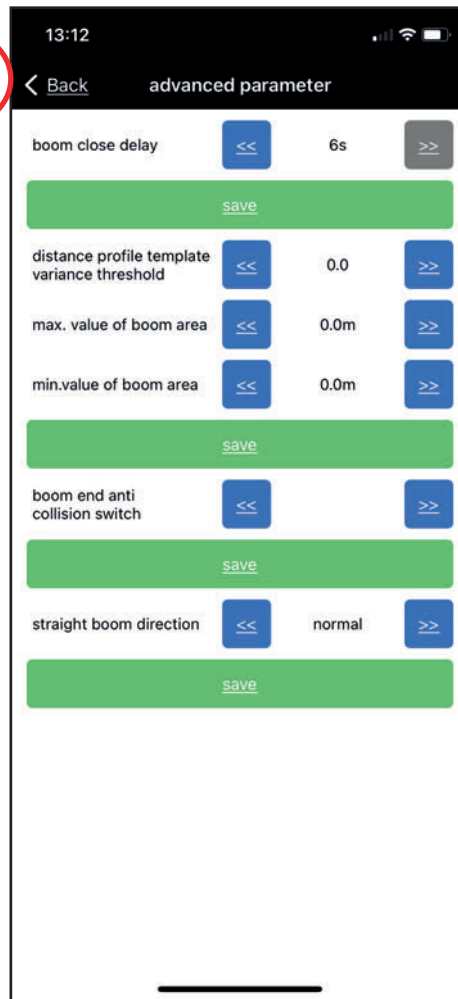

Figure 20

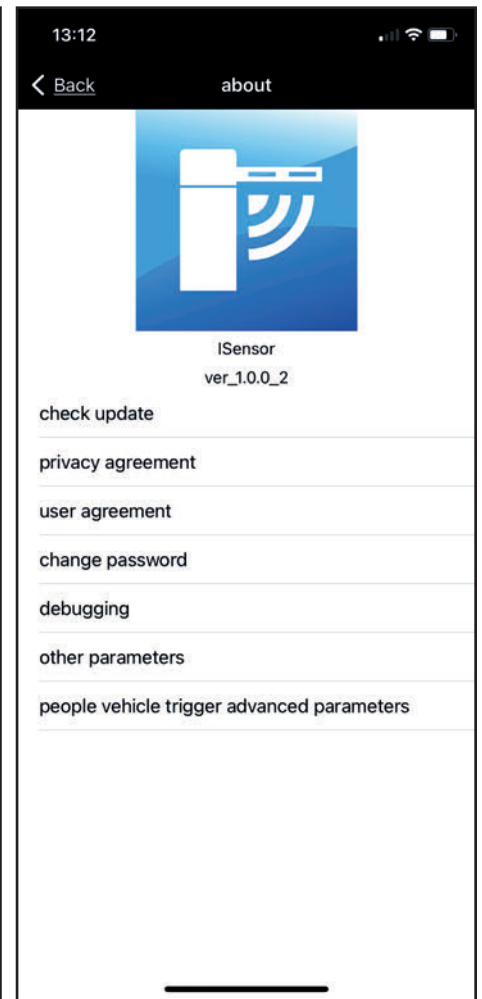

Figure 21

Remarks

Ensure stable power supply to avoid affecting the sensor performance, it is recommended to use 12V /1A power adapter separately for power supply.

Sensor antenna is integrated inside. if sensor surface covered with other things(such as water drops, snow, dust, etc.) which may affect the normal operation of the sensor, it shall be cleaned in time.

If environment changes (such as installing the guide column, ice cream cone, etc.) in the detection area, please learn to record the environment again.

There shall be no objects (such as metal fence, billboard, license plate recognition camera, wall, etc.) in the sensor detection field which will affect the normal operation.

It is not recommended to use sensor in a single lane where different types of barriers installed.

it is recommended to install 2 sensors or remote control barrier arm when for entry&exit of semi trailer, concrete mixer, and other vehicles which chassis higher than 1m.

It is not recommended to install sensor on muddy roads &extreme weather (rainstorm, heavy snow) which may affect the sensor operation stability.

Set the detection range based on the barrier arm length, normally this range is slightly less than or equal to the barrier arm length, so as to prevent people or objects from being detected by sensor when passing beyond the gate arm.

When environment record & learning, the fence / advertising type arm may shake when it falls to the ground. operation can be carried out after the arm falls completely.

Relearn the background if there is arm rebound caused by the sensor.

The installation height of the sensor should be 75-80cm in case of the metal strong scatterers like deceleration belt (for example iron plate are directly in front of the sensor.

Sensor applicable power supply : 9-24VDC. preferred 12V/1A power supply or connected to camera 12/24VDC power supply.

Common problems

Problem

The sensor green light always on after installation and the barrier arm doesn't fall.

Answer

New enhanced reflectors within the sensor detection area need to be removed from sensor field of view or background learning should be carried out again.

Problem

the person stand in front of the sensor, the green light is not on.

Answer

The sensor is activated pedestrian / vehicle classification function, when vehicles trigger the sensor and green light on, The sensor then can detect.

Problem

The sensor red light flashes.

Answer

It is recommended to connect an extra 12V-1A power adapter.



Gewerbepark Ruggölzli 2
5453 Busstlingen
Switzerland

www.digiparts.ch