

Amplifier Built-in Ultra-compact Type
Photoelectric Sensor

EX-20 Series

USER'S MANUAL

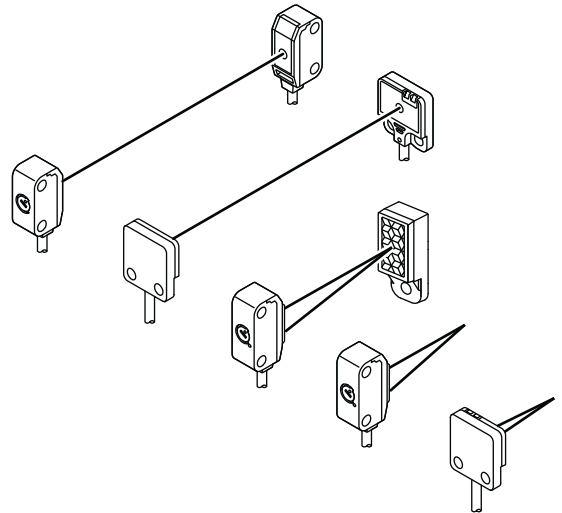

Contents

1. Cautions	3
2. Part Description	4
3. Mounting	6
3-1 Mounting the sensor	6
3-2 Mounting to sensor mounting bracket (Optional)	7
3-3 Mounting to mounting spacer (Optional) (Front sensing type)	8
3-4 Installation interval	9
3-5 Mounting when detecting materials having a gloss (Retroreflective type EX-29) ..	13
4. I/O Circuit Diagram	14
5. Adjustment	15
5-1 Beam alignment (Thru-beam type EX-21 / EX-23 , Retroreflective type EX-29) ..	15
5-2 Sensitivity adjustment (Diffuse reflective type EX-22 , Convergent reflective type EX-26 , Narrow-view reflective type EX-28)	16
6. Stability Indicator	18
7. Option	19
7-1 Slit mask (Thru-beam type EX-21 / EX-23)	19
7-2 Reflector / refractive tape (Retroreflective type EX-29)	20
8. Specifications	21
9. Dimensions	24

1. Cautions

WARNING

- Never use this product as a sensing device for personnel protection.
 - In case of using devices for personnel protection, use products which meet laws and standards, such as OSHA, ANSI or IEC etc., for personnel protection applicable in each region or country.
- This product has been developed / produced for industrial use only.
 - The thin cable (0.1mm²) is used for this product. Thus, take care that if the cable is pulled with excessive force, it may cause cable break.
 - Convergent reflective type **EX-24**□ are not incorporated with a sensitivity adjuster. If there is a reflective object (conveyor, etc.) in the background, since it may affect the sensing, use these models by keeping enough distance from the reflective object.
 - If a reflective object is present in the background, the sensing of narrow-view reflective type **EX-28**□ may be affected. When setting the sensor, make sure to confirm that the reflective object has no effect. In case the reflective object affects the sensing, take measures such as removing the reflective object or coloring it in black, etc.
 - If sensors are mounted close together and the ambient temperature is near the maximum rated value, provide for enough heat radiation / ventilation.
 - Make sure to carry out wiring in the power supply OFF condition.
 - Take care that wrong wiring will damage the sensor.
 - Verify that the supply voltage variation is within the rating.
 - If power is supplied from a commercial switching regulator, ensure that the frame ground (F.G.) terminal of the power supply is connected to an actual ground.
 - In case noise generating equipment (switching regulator, inverter motor, etc.) is used in the vicinity of this product, connect the frame ground (F.G.) terminal of the equipment to an actual ground.
 - Do not run the wires together with high-voltage lines or power lines or put them in the same raceway. This can cause malfunction due to induction.
 - Do not use during the initial transient time (50ms) after the power supply is switched ON.
 - Take care that the sensor is not directly exposed to fluorescent lamp from a rapid-starter lamp, a high frequency lighting device or sunlight etc., as it may affect the sensing performance.
 - Extension up to total 50m (each emitter and receiver of thru-beam type), or less, is possible with 0.3mm², or more of conductor area cable. However, the extension of a power supply line and the output line of less than 10m is acceptable in case using this product as conforming to S-mark.
 - This sensor is suitable for indoor use only.
 - Do not use this sensor in places having excessive vapor, dust, etc., or where it may come in contact with corrosive gas, etc.
 - Take care that the sensor does not come in contact with oil, grease, organic solvents such as thinner, etc., strong acid, or alkaline.
 - This sensor cannot be used in an environment containing inflammable or explosive gases.
 - Never disassemble or modify the sensor.

2. Part Description

Thru-beam type / Front sensing EX-21

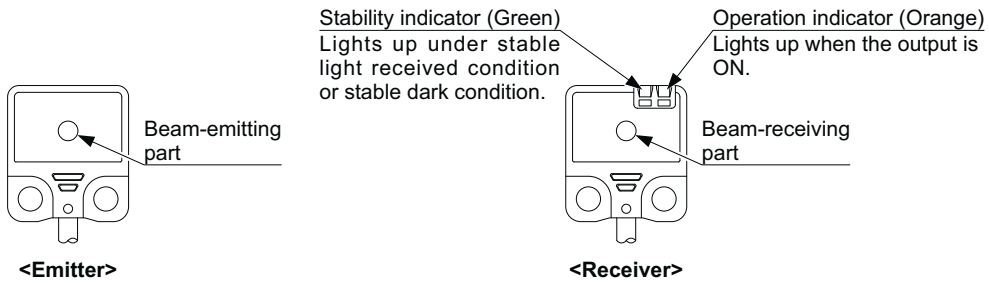

Thru-beam type / Side sensing EX-23

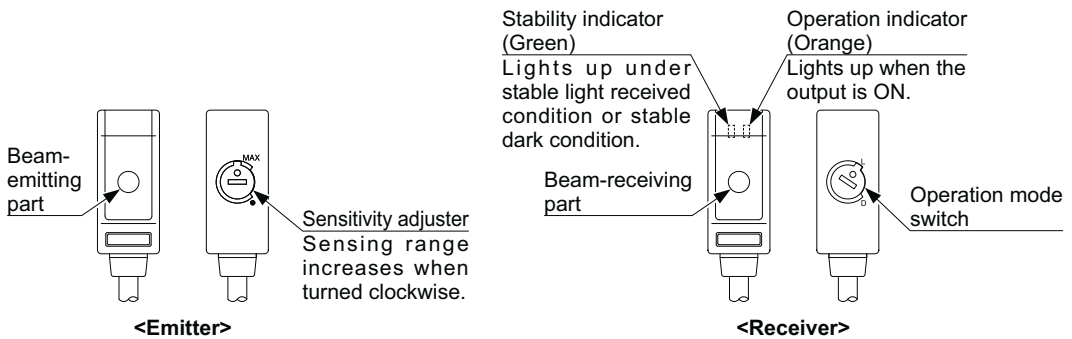

Operation mode switch	Operation	Description
	Light-ON	Light-ON mode is obtained when the operation mode switch is turned fully clockwise (L side).
	Dark-ON	Dark-ON mode is obtained when the operation mode switch is turned fully counterclockwise (D side).

Note: Use the accessory adjusting screwdriver to turn the operation mode switch slowly. Turning with excessive strength will cause damage to the adjuster.

Retroreflective type / Side sensing EX-29 □
Diffuse reflective type / Side sensing EX-22 □
Convergent reflective type / Side sensing EX-26 □
Narrow-view reflective type / Side sensing EX-28 □

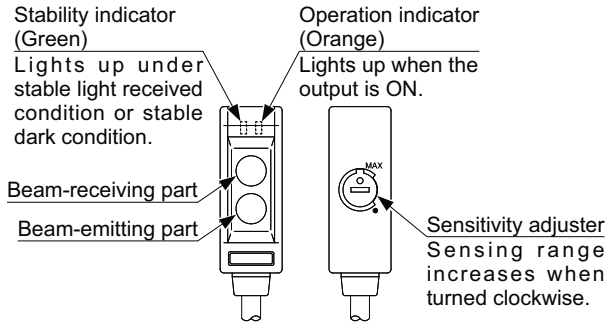

Convergent reflective type / Front sensing EX-24 □

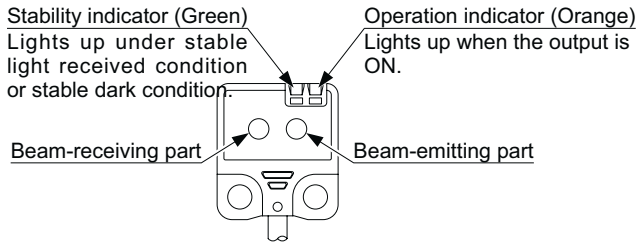

3. Mounting

3-1 Mounting the sensor

- Mount using M3 screws. The tightening torque should be 0.5N·m or less.

Front sensing type

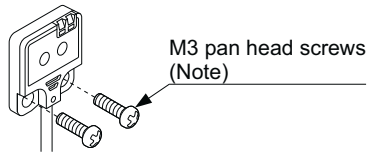

Side sensing type

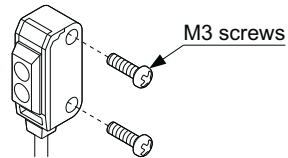

Note: When mounting the front sensing type sensor, use M3 pan head screws without washers, etc.

3-2 Mounting to sensor mounting bracket (Optional)

- Sensor mounting brackets (optional) are available. In case the sensor is mounted on a sensor mounting bracket the tightening torque should be 0.5N·m or less.

Sensor mounting bracket for front sensing type

- **MS-EX20-1**

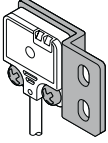

Material: Stainless steel (SUS304)
Two M3 (length 5mm) pan head screws [stainless steel (SUS304)] are attached.

- **MS-EX20-3**

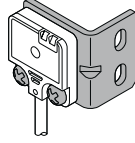

Material: Stainless steel (SUS304)
Two M3 (length 5mm) pan head screws [stainless steel (SUS304)] are attached.

Sensor mounting bracket for side sensing type

- **MS-EX20-2**

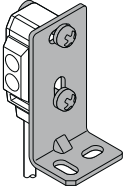

Material: Stainless steel (SUS304)
Two M3 (length 14mm) screws with washers [stainless steel (SUS304)] are attached.

- **MS-EX20-4**

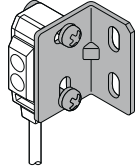

Material: Stainless steel (SUS304)
Two M3 (length 14mm) screws with washers [stainless steel (SUS304)] are attached.

- **MS-EX20-5 (For thru-beam type EX-23□)**

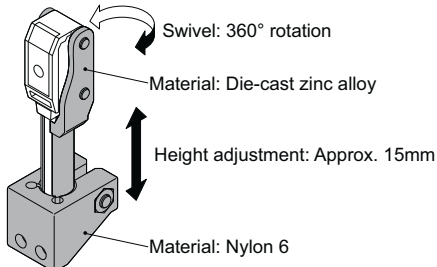

Two M3 (length 12mm) screws with washers [stainless steel (SUS304)], one M3 (length 10mm) hexagon-socket-head bolt [stainless steel (SUS304)], one M3 hexagon nut [stainless steel (SUS304)] are attached.

3-3 Mounting to mounting spacer (Optional) (Front sensing type)

- When mounting the front sensing type from the backside, fit the mounting spacer **MS-EX20-FS** and fix with screws.

Mounting method

1. Fit the mounting spacer on the sensor.
2. Align the mounting holes of the mounting spacer and the sensor and mount with M3 screws. The tightening torque should be 0.5N·m or less.

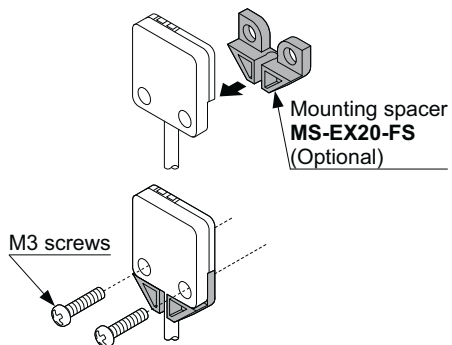

3-4 Installation interval

- This product does not incorporate auto interference prevention function. In case aligning 2 of this sensors closely, follow diagrams below. (typical)
- Find out the operating point ℓ on the parallel deviation diagram for the setting distance L. Separate sensors by $2 \times \ell$ or more.

Parallel deviation diagram (typical) of Thru-beam type EX-21□

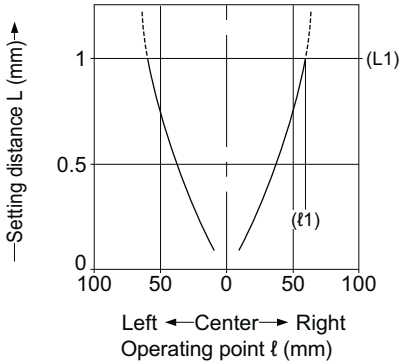

<Installation interval for EX-21□>

In case using at sensing distance (L1) 1m, the operation point (ℓ_1) is approx. 59.2mm according to left diagram.

The installation interval is

Approx. $59.2\text{mm} \times 2 =$ approx. 118.4mm

Thus, install **EX-21□** to approx. 118.4mm or more away.

Parallel deviation diagram (typical) of Thru-beam type EX-23□

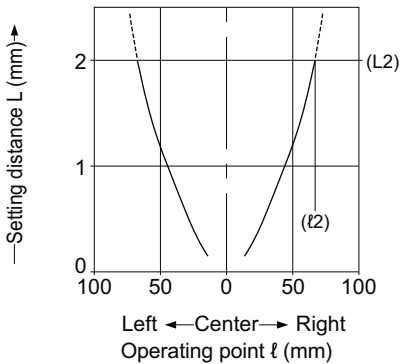

<Installation interval for EX-23□>

In case using at sensing distance (L2) 2m, the operation point (ℓ_2) is approx. 66.9mm according to left diagram.

The installation interval is

Approx. $66.9\text{mm} \times 2 =$ approx. 133.8mm

Thus, install **EX-23□** to approx. 133.8mm or more away.

Thru-beam type EX-21□ / EX-23□

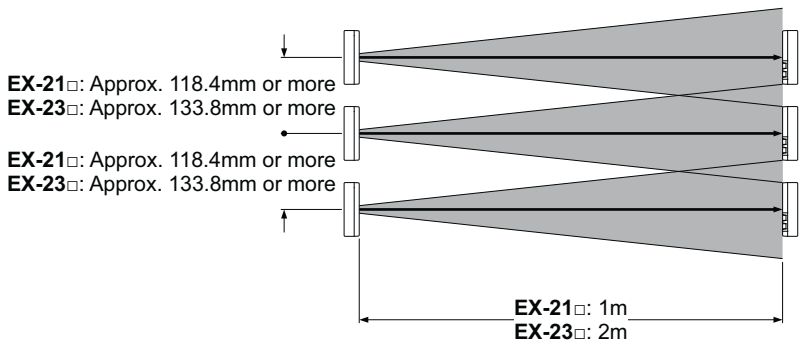

Parallel deviation diagram (typical) of Retroreflective type EX-29

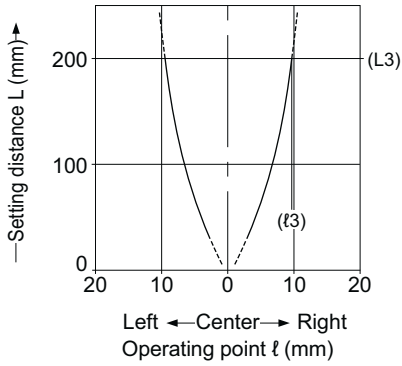

<Installation interval for EX-29>

In case using at sensing distance (L3) 200mm, the operation point ($l3$) is approx. 9.7mm according to left diagram.

The installation interval is

Approx. $9.7\text{mm} \times 2 = \text{approx. } 19.4\text{mm}$

Thus, install **EX-29** to approx. 19.4mm or more away.

Retroreflective type EX-29

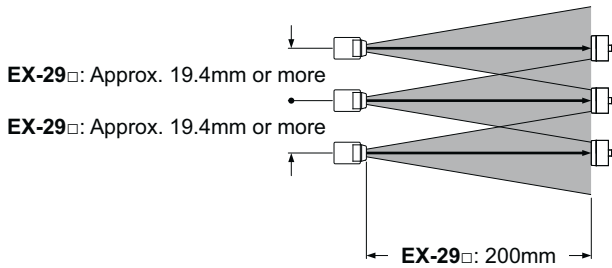

Sensing field diagram (typical) of Retroreflective type EX-22

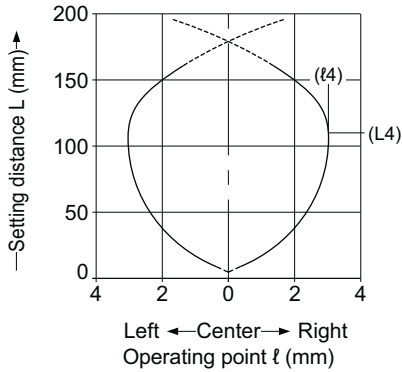

<Installation interval for EX-22>

In case using at sensing distance (L4) 120mm, the operation point (l4) is approx. 3.02mm according to left diagram.

The installation interval is

Approx. $3.02\text{mm} \times 2 = \text{approx. } 6.04\text{mm}$

Thus, install **EX-22** to approx. 6.04mm or more away.

Sensing field diagram / horizontal direction (typical) of Convergent reflective type EX-24

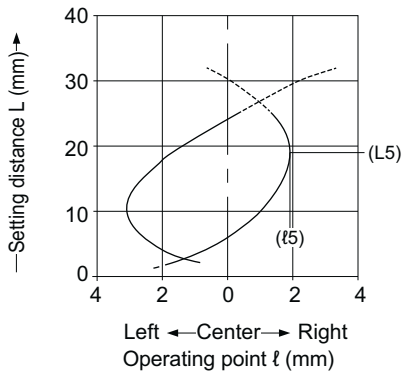

<Installation interval for EX-24>

In case using at sensing distance (L5) 19mm, the operation point (l5) is approx. 1.92mm according to left diagram.

The installation interval is

Approx. $1.92\text{mm} \times 2 = \text{approx. } 3.84\text{mm}$

Thus, install **EX-24** to approx. 3.84mm or more away.

Sensing field diagram / horizontal direction (typical) of Convergent reflective type EX-26

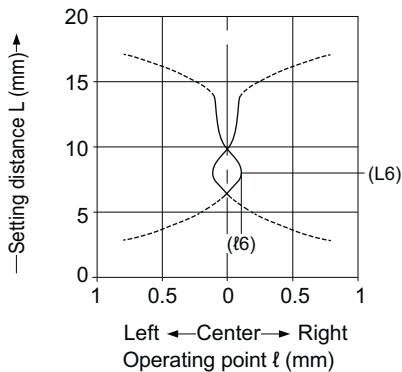

<Installation interval for EX-26>

In case using at sensing distance (L6) 8mm, the operation point (l6) is approx. 0.11mm according to left diagram.

The installation interval is

Approx. $0.11\text{mm} \times 2 = \text{approx. } 0.22\text{mm}$

Thus, install **EX-26** to approx. 0.22mm or more away.

Sensing field diagram (typical) of Narrow-view reflective type EX-28□

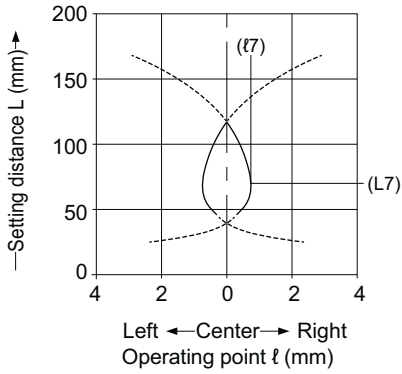

<Installation interval for EX-28□>

In case using at sensing distance (L7) 70mm, the operation point ($\ell 7$) is approx. 0.74mm according to left diagram.

The installation interval is

Approx. $0.74\text{mm} \times 2 = \text{approx. } 1.48\text{mm}$

Thus, install **EX-28□** to approx. 1.48mm or more away.

**Diffuse reflective type EX-22□, Convergent reflective type EX-24□ / EX-26□
Narrow-view reflective type EX-28□**

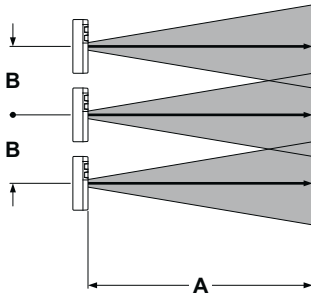

Model No.	A	B
EX-22□	120mm	Approx. 6.04mm or more
EX-24□	19mm	Approx. 3.84mm or more
EX-26□	8mm	Approx. 0.22mm or more
EX-28□	70mm	Approx. 1.48mm or more

3-5 Mounting when detecting materials having a gloss (Retroreflective type EX-29□)

- Please take care of the following points when detecting materials having a gloss with retroreflective type EX-29□.
 1. Make "L", shown in the diagram, sufficiently long. (*1)
 2. Install at an angle of 10 to 30 degrees to the sensing object.

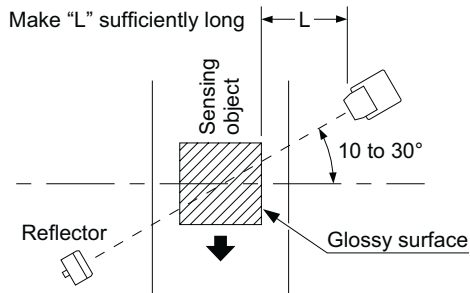

- *1: In case the distance between the sensing object and the sensor is not enough, reflected light from sensing object may enter to the sensor.

4. I/O Circuit Diagram

NPN output type and PNP output type common / Thru-beam type · emitter EX-21□ / EX-23□

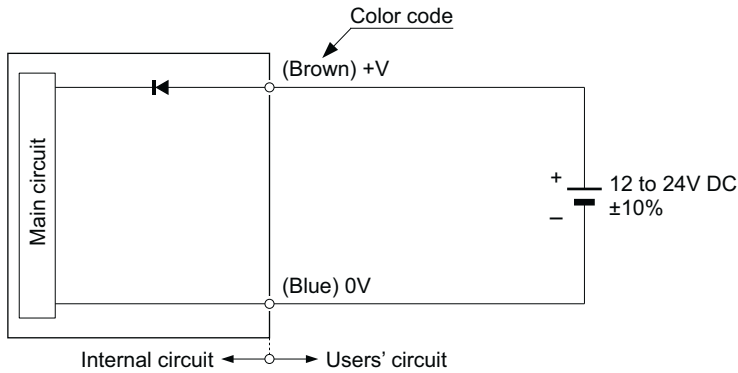

**NPN output type / Thru-beam type · receiver EX-21□ / EX-23□, Retroreflective type EX-29□
Diffuse reflective type EX-22□, Convergent reflective type EX-24□ / EX-26□
Narrow-view reflective type EX-28□**

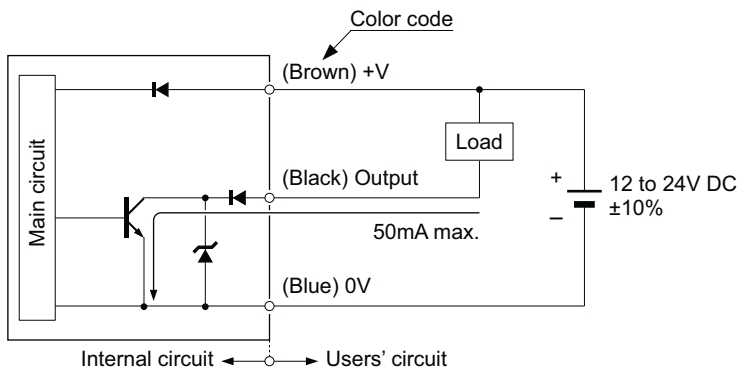

**PNP output type / Thru-beam type · receiver EX-21□-PN / EX-23□-PN, Retroreflective type EX-29□-PN
Diffuse reflective type EX-22□-PN, Convergent reflective type EX-24□-PN / EX-26□-PN
Narrow-view reflective type EX-28□-PN**

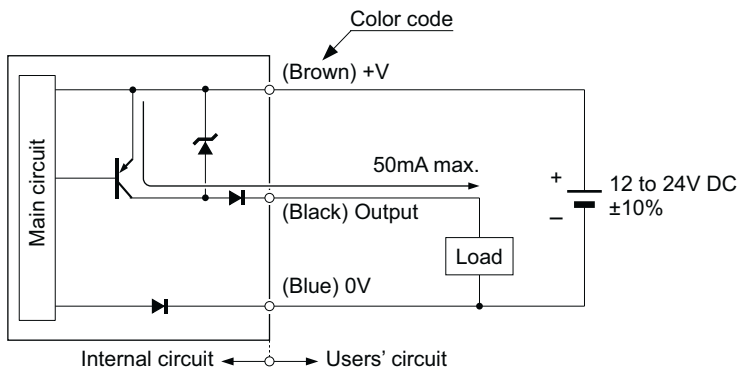

5. Adjustment

5-1 Beam alignment

(Thru-beam type EX-21□ / EX-23□, Retroreflective type EX-29□)

Thru-beam type EX-21□ / EX-23□

1. In case of EX-23□, set the operation mode switch to the Light-ON mode position (L side).
2. Placing the emitter and the receiver face to face along a straight line, move the emitter in the up, down, left and right directions, in order to determine the range of the light received condition with the help of the operation indicator (orange). Then, set the emitter at the center of this range.
3. Similarly, adjust for up, down, left and right angular movement of the emitter.
4. Further, perform the angular adjustment for the receiver also.
5. Check that the stability indicator (green) lights up.
6. In case of EX-23□, choose the operation mode, Light-ON or Dark-ON, as per your requirement, with the operation mode switch.

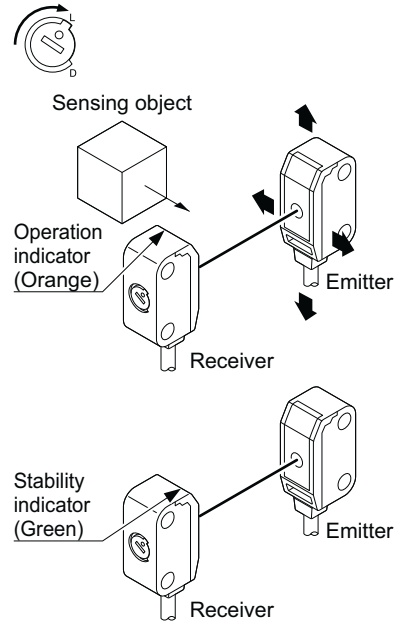

Retroreflective type EX-29□

1. Turn the sensitivity adjuster fully clockwise to the maximum sensitivity position (MAX).
2. Placing the sensor and the reflector face to face along a straight line, move the reflector in the up, down, left and right directions, in order to determine the range of the light received condition with the help of the operation indicator (orange). Then, set the reflector at the center of this range.
3. Similarly, adjust for up, down, left and right angular movement of the reflector.
4. Further, perform the angular adjustment for the sensor also.
5. Check that the stability indicator (green) lights up.

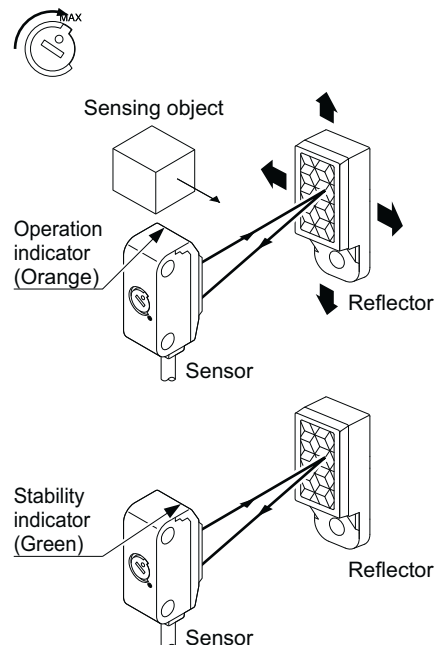

5-2 Sensitivity adjustment

(Diffuse reflective type EX-22□, Convergent reflective type EX-26□)
(Narrow-view reflective type EX-28□)

Step

1. Turn the sensitivity adjuster fully counterclockwise to the minimum sensitivity position (• mark).
2. In the light received condition, turn the sensitivity adjuster slowly clockwise and confirm the point **A** where the sensor enters the “Light” state operation.
3. In the dark condition, turn the sensitivity adjuster further clockwise until the sensor enters the “Light” state operation and then bring it back to confirm point **B** where the sensor just returns to the “Dark” state operation.
(If the sensor does not enter the “Light” state operation even when the sensitivity adjuster is turned fully clockwise, the position is point **B**.)
4. The position at the middle of points **A** and **B** is the optimum sensing position.

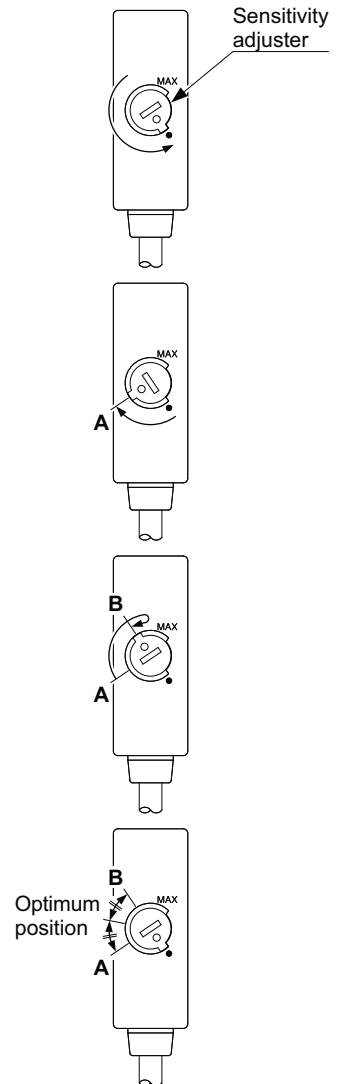

- Notes:
- 1) Use the accessory adjusting screwdriver to turn the adjuster slowly. Turning with excessive strength will damage the adjuster.
 - 2) In case of using EX-22□ at a sensing range of 50mm or less, take care that the sensitivity adjustment range becomes extremely narrow.

<Reference>

	Light received condition	Dark condition
Thru-beam type		
Retroreflective type		
Diffuse reflective type		
Convergent reflective type Narrow-view reflective type		

Relation between output and indicators

In case of Light-ON				In case of Dark-ON		
Stability indicator (Green)	Operation indicator (Orange)	Output	Sensing condition	Output	Operation indicator (Orange)	Stability indicator (Green)
Lights up	Lights up	ON	Stable light receiving	OFF	Turns OFF	Lights up
Turns OFF			Unstable light receiving			Turns OFF
Lights up	Turns OFF	OFF	Unstable dark receiving	ON	Lights up	Turns OFF
			Stable dark receiving			Lights up

6. Stability Indicator

- The stability indicator (green) lights up when the incident light intensity has sufficient margin with respect to the operation level. Incident light intensity level is such that the stability indicator light up, stable sensing can be done without the light received operation and the light interrupted operation being affected by a change in ambient temperature or supply voltage.

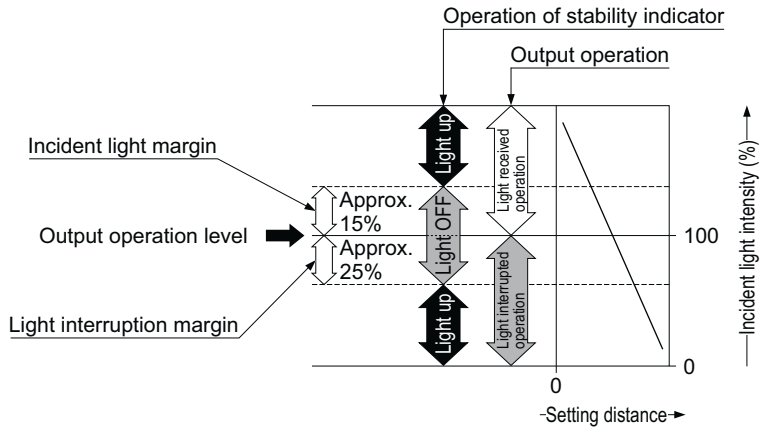

7. Option

7-1 Slit mask (Thru-beam type EX-21□ / EX-23□)

- With the slit mask **OS-EX20-□**, the sensor can detect a small object. However, the sensing range is reduced when the slit mask is mounted.

Type	Model No.		Slit size	Sensing distance		Min. sensing object	
	Slit mask	Slit size		Slit on one side	Slit on both side	Slit on one side	Slit on both side
Round slit mask	OS-EX20-05	EX21 □	ø0.5mm	200mm	40mm	ø2.6mm	ø0.5mm
	OS-EX20E-05	EX-23 □		350mm	70mm	ø3mm	ø0.5mm
Rectangular slit mask	OX-EX20-05×3	EX-21 □	0.5 × 3mm	600mm	300mm	ø2.6mm	0.5 × 3mm
	OX-EX20E-05×3	EX-23 □		800mm	400mm	ø3mm	0.5 × 3mm

- The slit mask should be mounted on the product before mounting the sensor.

Mounting method

1. Put the slit mask on the sensor as shown in the right figure.

Front sensing type EX-21□

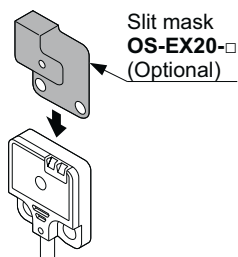

Side sensing type EX-23□

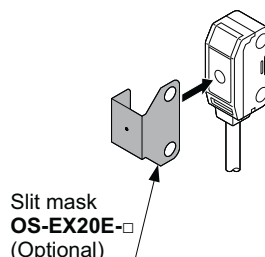

2. Align the mounting holes of the slit mask and the sensor and mount with two M3 screws [in case of EX-21□, M3 pan head screws]. The tightening torque should be 0.5N·m or less.

Front sensing type EX-21□

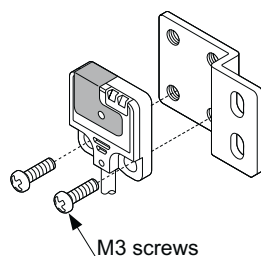

Side sensing type EX-23□

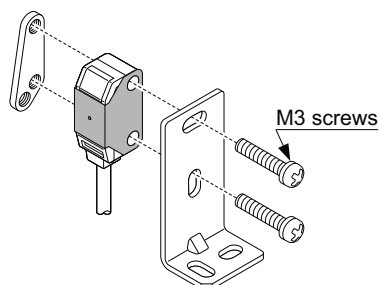

7-2 Reflector / refractive tape (Retroreflective type EX-29□)

- Reflector **RF-200** are accessory of retroreflective type **EX-29□**.
(we also offer them without refractor **RF-200**)
- In case using a optional reflector or reflective tape, the sensing distance is different.

Designation	Model No.		Installation distance		Sensing distance	Min. sensing object	Specification
	Sensor		A	B			
Reflector	RF-200 (Accessory)	EX-29□	30mm	200mm	30 to 200mm	ø15mm	Dimension (W × H × D): 9.6mm × 25.25mm × 8mm Thru-hole threads: ø3.2mm
	RF-210 (Optional)	EX-29□	50mm	400mm	50 to 400mm	ø30mm	Dimension (W × H × D): 33.3mm × 12.8mm × 11mm Thru-hole threads: ø3.4mm
Reflective tape	RF-11 (Optional)	EX-29□	70mm	200mm	70 to 200mm	ø15mm	Dimension (W × H × D): 30mm × 8mm × 0.7mm Ambient temperature: -25 to +50°C Ambient humidity 35 to 85% RH
	RF-12 (Optional)	EX-29□	60mm	280mm	60 to 280mm	ø15mm	Dimension (W × H × D): 30mm × 25mm × 0.7mm Ambient temperature: -25 to +50°C Ambient humidity 35 to 85% RH

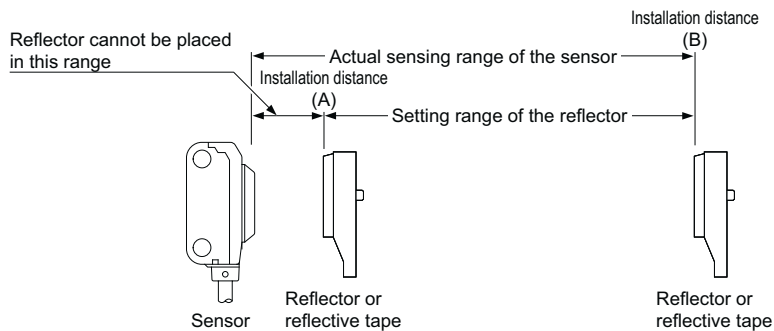

8. Specifications

Type		Thru-beam		Retroreflective
		Front sensing	Side sensing	Side sensing
Model No. (Note 2)	Light-ON	EX-21A	EX-23 (Note 3)	EX-29A
	Dark-ON	EX-21B		EX-29B
Sensing range		1m	2m	30 to 200mm (Note 4)
Sensing object		Min. ø2.6mm opaque object (Setting distance between emitter and receiver: 1m)	Min. ø3mm opaque object (Setting distance between emitter and receiver: 2m)	ø15mm or more opaque or translucent object (Note 4, 6)
Hysteresis		-		
Repeatability (perpendicular to sensing axis)		0.05mm or less		0.5mm or less
Supply voltage		12 to 24V DC±10% Ripple P-P 10% or less		
Current consumption		Emitter: 10mA or less, Receiver: 10mA or less		13mA or less
Output		<NPN output type> NPN open-collector transistor		<PNP output type> PNP open-collector transistor
		<ul style="list-style-type: none"> • Maximum sink current: 50mA • Applied voltage: 30V DC or less (between output and 0V) • Residual voltage: 2V or less (at 50mA sink current) 1V or less (at 16mA sink current) 		<ul style="list-style-type: none"> • Maximum source current: 50mA • Applied voltage: 30V DC or less (between output and +V) • Residual voltage: 2V or less (at 50mA source current) 1V or less (at 16mA source current)
Short-circuit protection		Incorporated		
Response time		0.5ms or less		
Protection		IP67 (IEC)		
Ambient temperature		-25 to +55°C (No dew condensation or icing allowed), Storage: -30 to +70°C		
Ambient humidity		35 to 85% RH, Storage: 35 to 85% RH		
Emitting element		Red LED (modulated)		
Material		Enclosure: Polyethylene terephthalate, Lens: Polyallylate		
Cable		0.1mm ² 3-core (thru-beam type sensor emitter: 2-core) cabtyre cable, 2m long		
Weight	Net weight	Emitter, receiver: Approx. 20g each		Approx. 20g
	Gross weight	Approx. 50g		Approx. 30g
Accessories		-	Adjusting screwdriver: 1 pc.	RF-200 (Reflector): 1 pc. Adjusting screwdriver: 1 pc.

Type		Diffuse reflective	Convergent reflective		Narrow-view reflective	
			Diffused beam type	Small spot beam type	Long distance spot beam type	
		Side sensing	Front sensing	Side sensing	Side sensing	
Model No. (Note 2)	Light-ON	EX-22A	EX-24A	EX-26A	EX-28A	
	Dark-ON	EX-22B	EX-24B	EX-26B	EX-28B	
Sensing range		5 to 160mm (With 200 × 200mm white non-glossy paper) (Note 5)	2 to 25mm (Conv. point: 10mm) (With 50 × 50mm white non-glossy paper)	6 to 14mm (Conv. point: 10mm) (With 50 × 50mm white non-glossy paper, spot diameter ø1mm with setting distance 10mm.)	45 to 115mm (With 100 × 100mm white non-glossy paper, spot diameter ø5mm with setting distance 80mm.)	
Sensing object		Opaque, translucent or transparent object (Note 6)	Min. ø0.1mm copper wire (Setting distance: 10mm)	Min. ø0.1mm copper wire (Setting distance: 10mm)	Opaque, translucent or transparent object (Min. ø1mm copper wire which setting dis- tance: 80mm)	
Hysteresis		15% or less operation distance [50 × 50mm (EX-22□: 200 × 200mm, EX-28□: 100 × 100mm) white non-glossy paper]				
Repeatability (perpendicular to sensing axis)		0.3mm or less	0.1mm or less (Setting distance: 10mm)	0.05mm or less (Setting distance: 10mm)	0.3mm or less	
Supply voltage		12 to 24V DC±10% Ripple P-P 10% or less				
Current consumption		13mA or less			15mA or less	
Output		<NPN output type> NPN open-collector transistor <ul style="list-style-type: none"> • Maximum sink current: 50mA • Applied voltage: 30V DC or less (between output and 0V) • Residual voltage: 2V or less (at 50mA sink current) 1V or less (at 16mA sink current) 		<PNP output type> PNP open-collector transistor <ul style="list-style-type: none"> • Maximum source current: 50mA • Applied voltage: 30V DC or less (between output and +V) • Residual voltage: 2V or less (at 50mA source current) 1V or less (at 16mA source current) 		
Short-circuit protection		Incorporated				
Response time		0.5ms or less				
Protection		IP67 (IEC)				
Ambient temperature		-25 to +55°C (No dew condensation or icing allowed), Storage: -30 to +70°C				
Ambient humidity		35 to 85% RH, Storage: 35 to 85% RH				
Emitting element		Red LED (modulated)				
Material		Enclosure: Polyethylene terephthalate, Lens: Polyallylate				
Cable		0.1mm ² 3-core cabtyre cable, 2m long				
Weight	Net weight	Approx. 20g				
	Gross weight	Approx. 30g				
Accessories		Adjusting screwdriver: 1 pc.	–	Adjusting screwdriver: 1 pc.		

- Notes: 1) Where measurement conditions have not been specified precisely, the conditions used were an ambient temperature of +23°C.
- 2) The model No. with suffix “-PN” is PNP output type.
 (Example) PNP output type of **EX-21A: EX-21A-PN**
 “P” marked in the model no. of cable of thru-beam type is emitter and “D” is receiver.
 (Example) Emitter of **EX-21A: EX-21P**, Receiver of **EX-21A: EX-21AD**
 The model No. of retroreflective type sensor with the suffix “-Y” is the sensor without the **RF-200** reflector.
 (Example) Without reflector type of **EX-29A-PN: EX-29A-PN-Y**
 The model No. with suffix “-C5” is 5m cable length type. (Excluding PNP output type)
 (Example) 5m cable length type of **EX-29A-Y: EX-29A-Y-C5**
- 3) Either Light-ON or Dark-ON can be selected by the operation mode switch (located on the receiver).
- 4) The sensing range and the sensing object of the retroreflective type sensor are specified for the **RF-200** reflector. Further, the sensing range is the possible setting range for the reflector. The sensor can detect an object less than 30mm away. However, if the reflector is set 100mm or less away, the sensing object should be opaque.

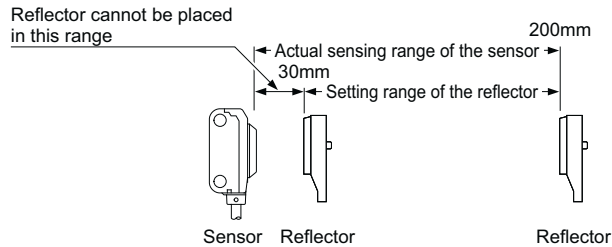

- 5) In case of using this product at a sensing range of 50mm or less, take care that the sensitivity adjustment range becomes extremely narrow.
- 6) Make sure to confirm detection with an actual sensor before use.

9. Dimensions

Thru-beam type EX-21

(Unit: mm)

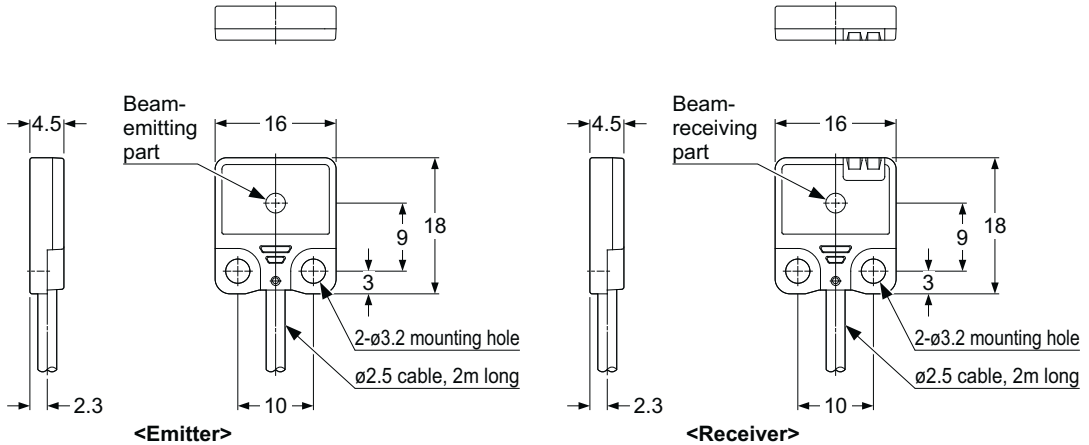

Thru-beam type EX-23

(Unit: mm)

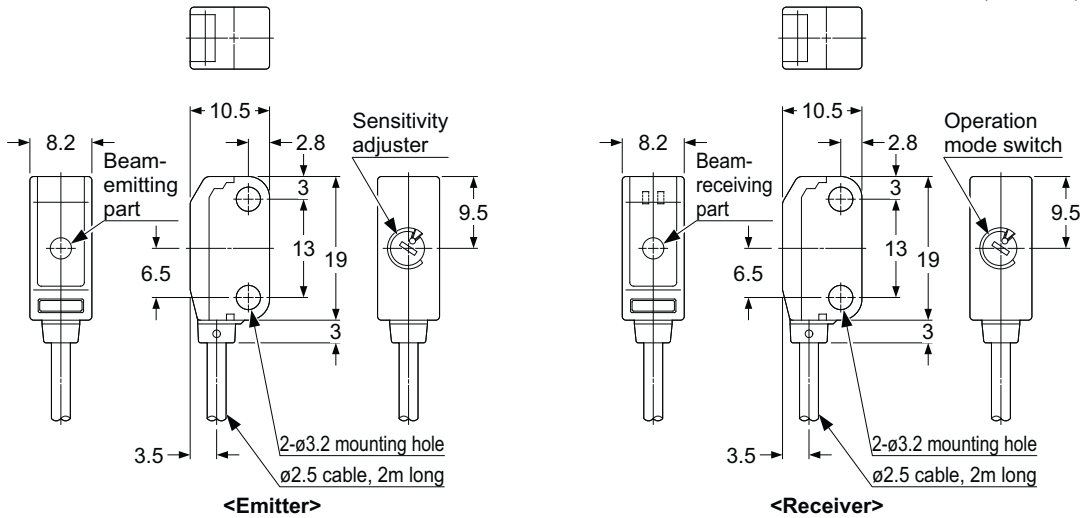

**Retroreflective type EX-29□, Diffuse reflective type EX-22□
Convergent reflective type EX-26□, Narrow-view reflective type EX-28□**

(Unit: mm)

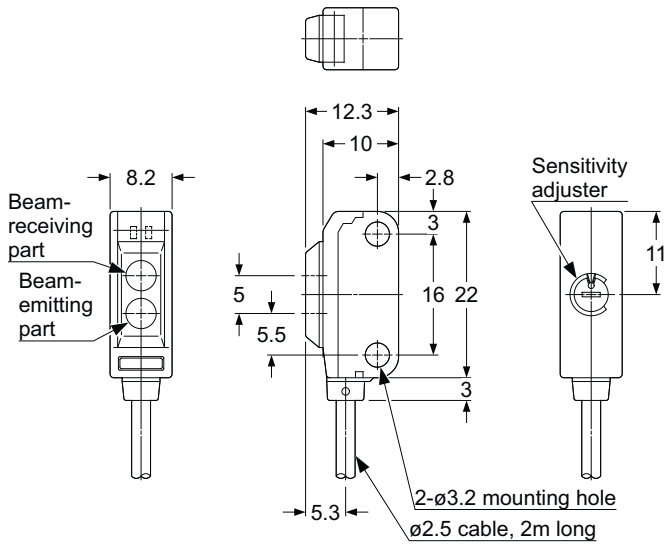

Convergent reflective type EX-24□

(Unit: mm)

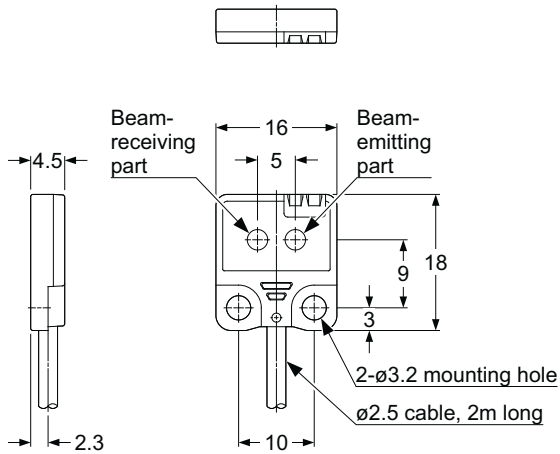

Reflector RF-200

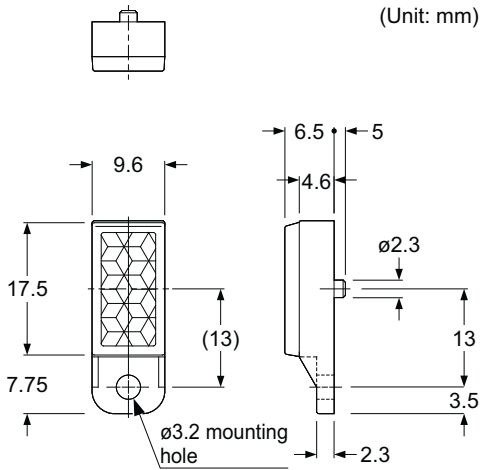

Reflector RF-210

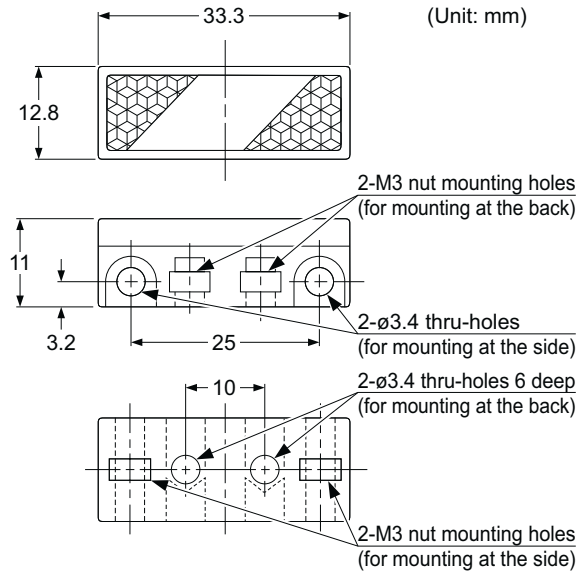

Reflective tape RF-11

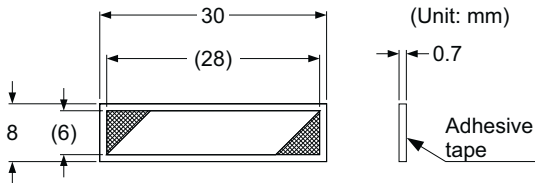

Reflective tape RF-12

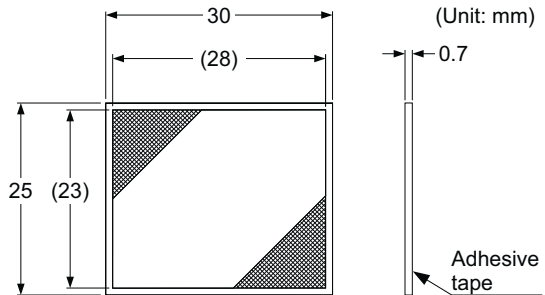

(MEMO)

Please contact

Panasonic Industrial Devices SUNX Co., Ltd.

■ Overseas Sales Division (Head Office): 2431-1 Ushiyama-cho, Kasugai-shi, Aichi, 486-0901, Japan
■ Telephone: +81-568-33-7861 ■ Facsimile: +81-568-33-8591

panasonic.net/id/pidsx/global

About our sale network, please visit our website.

December, 2012 PRINTED IN JAPAN

© Panasonic Industrial Devices SUNX Co., Ltd. 2012
WUME-EX20-3