

# KIRAY 300

## Infrared thermometer

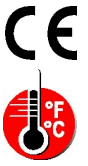

Infrared thermometer **KIRAY 300** is a thermometer used to diagnose, inspect and check any temperature. Thanks to its elaborated optical system with a dual laser sighting, it allows easy and accurate measurements of little distant targets. The **KIRAY 300** instrument has an internal memory which can save up to 100 measurements. Compatible with thermocouple K probe.

### TECHNICAL FEATURES

#### • Instrument features

Spectral response	8 -14 $\mu$ m
Optical	D.S : 50:1 (50.8 mm at 2540 mm)
Response time	150 ms
Temperature range	From -50 to +1850 °C
Accuracy*	From -50 to +20 °C : $\pm 3$ °C From +20 to +500 °C : $\pm 1\% \pm 1$ °C From +500 to +1000 °C : $\pm 1.5\%$ From +1000 to +1850 °C : $\pm 2\%$
Infrared repeatability	From -50 to +20 °C : $\pm 1.5$ °C From +20 to +1000 °C : $\pm 0.5\%$ or $\pm 0.5$ °C From +1000 to +1850 °C : $\pm 1\%$
Display resolution	0.1 C °
Emissivity	Adjustable from 0.10 to 1.00 (pre-set at 0.95)
Over range indication	Display indication : « ---- »
Dual laser sighting	Wavelength : from 630 nm to 670 nm Output < 1mW, Class 2 (II)
Positive or negative temperature indication	Automatic (no indication for a positive temperature) (-) sign for a negative temperature
Display	3 lines, 4 digits with backlighted display LCD
Auto-extinction	Automatic after 7 seconds of inactivity
High/low alarm	Flashing signal on display and beep signal with adjustable thresholds
Power supply	Alkaline 9 V battery
Autonomy	95 h (inactive laser and backlight) 15 h (active laser and backlight)
Use temperature	From 0 to +10 °C for a short period From 11 to +50 °C for a long period
Storage temperature	From -10 °C to +60 °C
Relative humidity	From 10% to 90%RH in operating mode and >80%RH in storage
Dimensions	200 x 140 x 50 mm
Weight	320 g (included battery)
Memory	100 temperature values
*Accuracy for an ambient temperature from 23 to 25 °C (with a relative humidity lower than 80% RH)	
<b>• Thermocouple K probe features</b>	
Temperature range	From -40 to +400 °C
Display range	From -50 to +1370 °C
Resolution	0.1 °C
Accuracy	$\pm 1.5\%$ of reading $\pm 3$ °C
Cable length	1 m

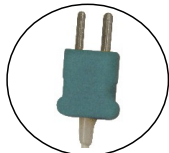

Supplied with thermocouple K probe

### DISTANCE FROM THE TARGET

Distance	1270	2540	3810	mm
Diameter	25.4	50.8	76.2	mm

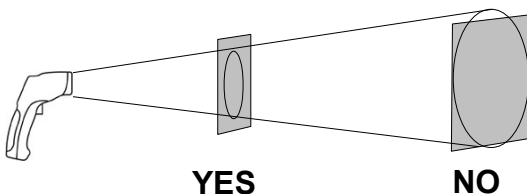

Make sure that the target is larger than the size of the laser sighting.

## KIRAY 300 INSTRUMENT DESCRIPTION

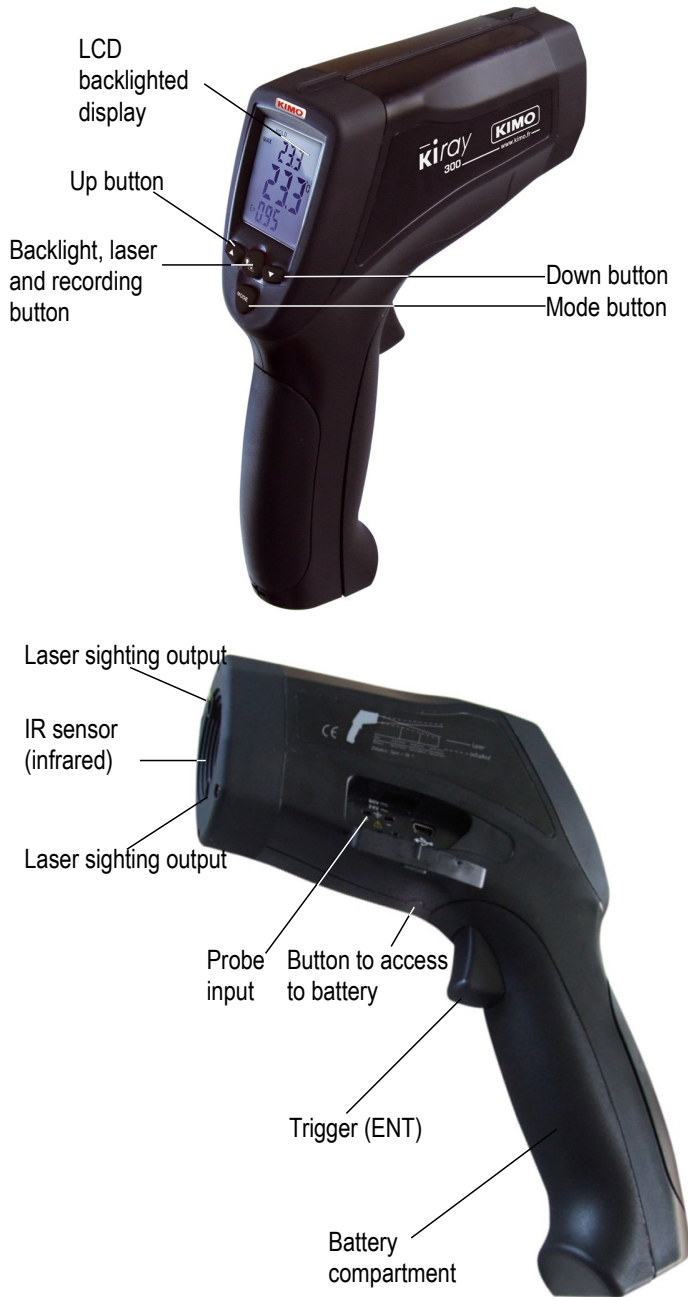

## MODES FLOW CHART

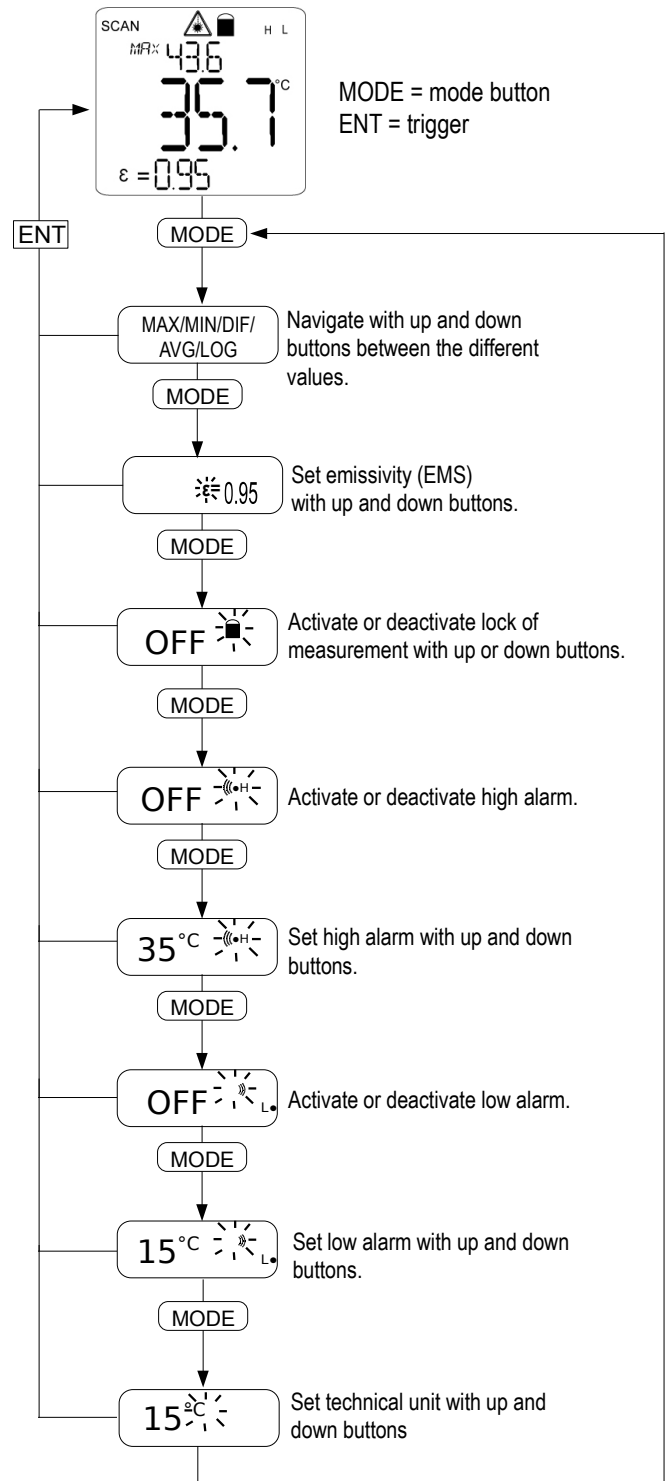

## KIRAY 300 INSTRUMENT BUTTONS



1 - Up button. It allows to increment emissivity and high and low alarm thresholds and to go to the following recorded value. It also allows to navigate between MAX, MIN, AVG and LOG.

2 - Backlight/laser button. It allows to activate or to deactivate laser backlight of the screen. You can also saved a value.

3 - Mode button. It allows to navigate through the modes (MAX and MIN values, DIF and AVG, emissivity, high and low alarms, unit of measurement).

4 - Down button. It allows to decrement emissivity and high and low alarm thresholds and to go to the following recorded value. It also allows to navigate between MAX, MIN, AVG and LOG.

## MODE MAX/MIN/DIF/AVG/LOG FLOW CHART

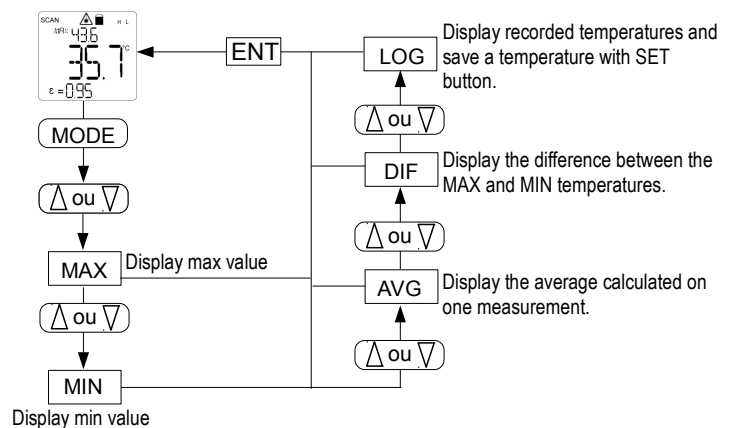

## DISPLAY

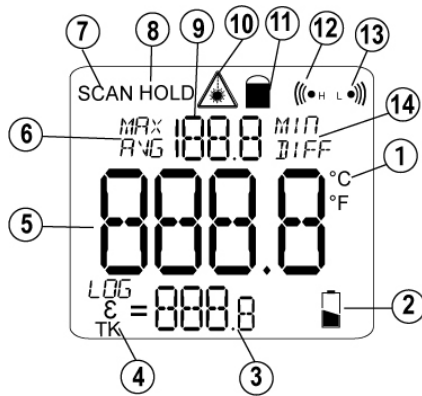

- 1 - Unit of measurement (°C / °F)
- 2 - Low battery indicator
- 3 - LOG value (recorded value), EMS (emissivity) and TK (K thermocouple probe)
- 4 - LOG, EMS, TK indicator
- 5 - Temperature value
- 6 - MAX and AVG (average) indicator
- 7 - Current measurement indicator
- 8 - HOLD (fixed measurement) indicator
- 9 - MAX, MIN, AVG, DIF value
- 10 - Laser operation indicator
- 11 - Continuous measurement indicator
- 12 - High alarm indicator
- 13 - Low alarm indicator
- 14 - MIN and DIF (difference between MIN and MAX values) indicator

## OPERATING MODE

- Push on the **ENT** trigger to turn on the instrument. The backlighted screen, indicating temperature and laser, turn on.
- Keep **ENT** pressed. Put the laser sighting at the middle of the area you want to measure.
- Release **ENT**.
- Read the displayed temperature. (Display stays activated during 7 seconds after the last manipulation).
- **HOLD** appears at the top left of the screen ; measurement stays displayed.
- Press **UP** or **DOWN** button to change technical unit.



During a measurement, the emissivity value is automatically displayed at the bottom left of the screen. But if the thermocouple K probe is connected, the measured value by the probe will be displayed at the bottom left of the screen.

## COMMAND BUTTONS

### **ENT** Trigger

- Turning on the instrument.
  - **ENT** pressed : activation of the laser sighting and of the temperature measurement.
- While maintaining **ENT** key, it is possible to change the value of the emissivity by pressing **UP** or **DOWN**.
- Still maintaining **ENT** key, it is possible to visualize the MAX, MIN, DIF, AVG values by pressing the **MODE** button.
- **ENT** released : Display is on **HOLD** (fixed **HOLD**), and gives the last measurement. The screen stays on 7 seconds. If no buttons are activated and if continuous measurement is inactive, the instrument turns off after 7 seconds.

### **MODE** Mode button

It allows to set measurement type : emissivity, lock, high alarm, low alarm, record values, etc ... by pressing as many times on this button.

- **EMS** : when **KIRAY300** instrument is turned on, press **MODE** until **ε=** flashes. Set emissivity pressing **UP** button to increment it or **down** button to decrement it. Emissivity is pre-set on 0.95.  
To return on measurement, press **ENT** ; press **MODE** to switch to next mode.

- **Lock** : when **KIRAY300** instrument is turned on, press **MODE** until the lock at the top of the screen flashes and **OFF** displays. Press **UP** or **DOWN** button to put the lock **ON**  
Press **MODE** to switch to the next mode, or press once **ENT** : the **KIRAY300** instrument takes continuous measurement. To cancel the lock, press once **ENT**.

- **High alarm** : when **KIRAY300** instrument is turned on, press **MODE** until **H** flashes at the top of the screen to the right. Press **UP** or **DOWN** button to activate or deactivate the alarm, then press **MODE** to adjust the alarm threshold. Increment threshold with **UP** button and decrement threshold with **DOWN** button.  
To return on measurement, press **ENT** ; press **MODE** to switch to next mode.

- **Low alarm** : when **KIRAY300** instrument is turned on, press **MODE** until **L** flashes at the top of the screen to the right. Press **UP** or **DOWN** button to activate or deactivate the alarm, then press **MODE** to adjust the alarm threshold. Increment threshold with **UP** button and decrement threshold with **DOWN** button.  
To return on measurement, press **ENT** ; press **MODE** to switch to next mode.

- **°C / °F** : when **KIRAY300** instrument is turned on, press **MODE** until technical unit flashes at the right of the displayed value. Press **UP** or **DOWN** button to change unit : °C or °F degree.  
To return on measurement, press **ENT** ; press **MODE** to switch to next mode.

**LOG** : while a measurement (**ENT** pressed or lock activated), press **MODE** until **LOG** appears at the bottom of the screen to the left. At the top of the screen, a number between 1 and 100 is also shown ; it is the **LOG** location. If nothing has been recorded 4 dashed line «----» appears while the temperature corresponding to the number appears if a temperature has been recorded.  
To save a temperature, you have to be on **LOG** mode, then choose an empty location (---- visible) and press **laser/backlight** button during measurement or the measurement is fixed (**HOLD**).  
From this mode, you can also clear all the recorded temperatures : press and hold the trigger and press **DOWN** button at the same time until reach zero recording, then press **laser/backlight** button while keep **ENT** pressed. A beep is emitted and **LOG** location will automatically change to "1", signifying that all data locations have been cleared.

## EMISSIVITY

Emissivity is a term used to describe the energy-emitting characteristics of materials.

Most (90% of typical applications) organic materials and painted or oxidized surfaces have an emissivity of 0.95 (pre-set in the unit). Inaccurate readings will result from measuring shiny or polished metal surfaces. To compensate; cover the surface to be measured with masking tape or flat black paint. Allow time for the tape to reach the same temperature as the material underneath it. Measure the temperature of the tape or painted surface.

See table below for values of emissivity of specific materials :

Aluminium	0.30	Ice	0.98
Asbestos	0.95	Iron	0.70
Asphalt	0.95	Lead	0.50
Basalt	0.70	Limestone	0.98
Brass	0.50	Oil	0.94
Brick	0.90	Paint	0.93
Carbon	0.85	Paper	0.95
Ceramic	0.95	Plastic	0.95
Concrete	0.95	Rubber	0.95
Copper	0.95	Sand	0.90
Dirt	0.94	Skin	0.98
Frozen food	0.90	Snow	0.90
Hot food	0.93	Steel	0.80
Glass	0.85	Textile	0.94
Water	0.93	Wood	0.94
Fresh foodstuffs between 0 and 5 °C			0.90

## MAINTENANCE

To install or change the 9V battery, open the part near the trigger and put it in the battery compartment..

## CE CERTIFICATION

This device meets with following standards' requirements.

EN 61326-1 : 2013 and EN 61326-2 : 2013



### Infrared thermometer, how does it work?

Infrared thermometers can measure the surface temperature of an object. Its optic lens catches the energy emitted and reflected by the object. This energy is collected and focused onto a detector. This information is displayed as temperature. The laser pointer is only used to aim at the target.

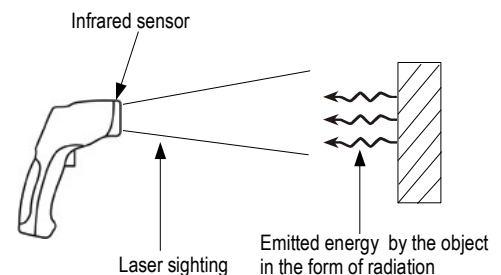

## IMPORTANT INFORMATION

For correct measurements :

- Do not take any measurement on metal or shiny or reflective surfaces.
- Do not measure through transparent surfaces such as glass, for example.
- Water vapor, dust, smoke, etc ... may prevent correct measurements because they obstruct the optical of the instrument.
- Make sure that the target is larger than the size of the aiming point of laser.

To avoid any inconvenience:

- Do not aim directly or indirectly (reflection on reflective surfaces) the laser in the eyes.
- Change the batteries when the indicator blinks.
- Do not use the thermometer around explosive gas, vapor or dust
- Do not leave the device with the lock on (lock at the top right of the screen) because in this configuration, the instrument does not turn off automatically.

To prevent damage on your instrument or equipment please carefully respect these conditions :

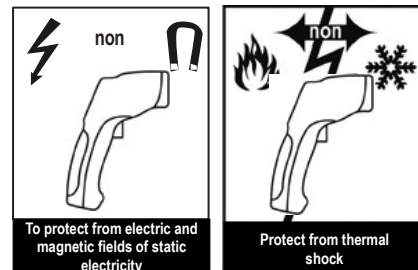

## ACCESSORIES

- Transport case
- User manual
- Thermocouple K probe
- Tripod



Once returned, required waste collection will be assured in the respect of the environment in accordance to 2002/96/CE guidelines relating to WEEE.