

USER MANUAL

CLASS 220 KISTOCK

KT 220, KH 220 and KTT 220

Table of contents

1	Safety instructions.....	3
1.1	Precautions for use.....	3
1.2	Symbols used.....	3
2	Presentation of the device.....	4
2.1	Use.....	4
2.2	Applications.....	4
2.3	References.....	4
2.4	Description of the device.....	4
2.5	Description of keys.....	5
2.6	Description of LEDs.....	5
2.7	Connections.....	5
2.8	Mounting.....	5
3	Technical features.....	6
3.1	Technical features of the devices.....	6
3.2	Features of the housing.....	7
3.3	Optional probes and cables.....	8
3.4	Dimensions (in mm).....	9
3.4.1	Devices.....	9
3.4.2	Wall mount.....	9
3.5	Guarantee period.....	9
4	Use of the device.....	10
4.1	Display.....	10
4.2	Functions of LEDs.....	10
4.3	Functions of keys.....	11
4.3.1	Groups organisation.....	13
4.3.2	Measurements scroll.....	13
4.4	PC communication.....	13
4.5	Configuration, datalogger download and data processing with the KILOG software.....	13
5	Maintenance.....	14
5.1	Replace the battery.....	14
5.2	Device cleaning.....	14
5.3	Safety lock wall mount with padlock.....	14
6	Calibration.....	15
7	Accessories.....	15
8	Troubleshooting.....	15

1.1 **Precautions for use**

Please always use the device in accordance with its intended use and within parameters described in the technical features in order not to compromise the protection ensured by the device.

1.2 **Symbols used**

For your safety and in order to avoid any damage of the device, please follow the procedure described in this user manual and read carefully the notes preceded by the following symbol:



The following symbol will also be used in this user manual:

Please read carefully the information notes indicated after this symbol.



2.1 Use

The class 220 **KISTOCK** dataloggers allow the measurement of several parameters:

- KT 220: internal measurement of temperature and one external universal input for probe
- KH 220: internal measurement of temperature, humidity and light and one external universal input for probe
- KTT 220: thermocouple temperature measurement and two thermocouple external inputs

This class of devices is available with or without display.

The communication between the device and the computer is carried out via an USB cable with the female micro-USB connector.

2.2 Applications

The **KISTOCK** dataloggers are ideal for the control of several parameters (temperature, humidity, light, current, voltage, impulsion, relative pressure...). They ensure the traceability in the food industry environment as well as they validate the proper functioning of industrial installations.



2.3 References

Device reference	Display	Internal sensors		External sensors		Parameters	Number of recording points
		Number	Type	Number	Type		
KT 220 - O	Yes	1	Temperature	1	Input for universal probes*	Temperature, humidity, current, voltage, impulsion, water pressure	1 000 000
KT 220 - N	No						
KH 220 - O	Yes	3	Temperature, humidity, light				
KH 220 - N	No						
KTT 220 - O	Yes	-		2	Inputs for thermocouple probes	Temperature	
KTT 220 - N	No						

* Input which allows to plug several compatible probes: please see the optional cables and probes page 8.

2.4 Description of the device



2.5 Description of keys



OK key: allows to start or stop the dataset or change of scrolling group (see page 11)

Selection key: allows the functions scroll (see page 11)

2.6 Description of LEDs



2.7 Connections

The communication between the device and the computer is carried out via a USB cable and with the female micro-USB connector.

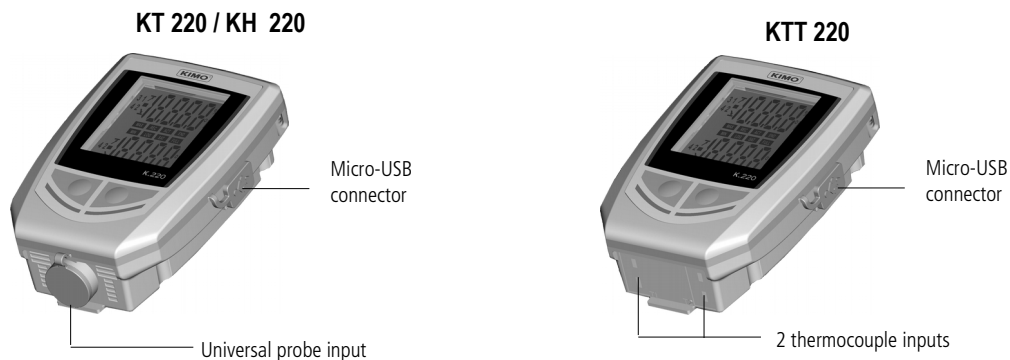

2.8 Mounting

The class 220 **KISTOCK** has magnetic mountings, so you can fix it easily.



3.1 Technical features of the devices

	KT 220	KH 220	KTT 220
Units displayed	°C, °F, °Ctd, °Ftd, %RH, mV, V, mA, A, bar ¹	°C, °F, °Ctd, °Ftd, %RH, lux, fc, mV, V, mA, A, bar ¹	°C, °F
Resolution	0.1°C, 0.1°F, 0.1%RH, 1 mV, 0.001 V, 0.001 mA, 0.1 A, 0.1 bar	0.1°C, 0.1°F, 0.1%RH, 1 lux, 0.1 fc, 1 mV, 0.001 V, 0.001 mA, 0.1 A, 0.1 bar	0.1°C, 0.1°F
External input	Female micro-USB connector		
Input for probe	1 universal input ²	1 universal input ²	2 inputs for thermocouple probes (K, J, T, N, S)
Internal sensor	Temperature	Temperature, humidity, light	Temperature
Type of sensor	NTC	<u>Temperature</u> : NTC <u>Humidity</u> : capacitive <u>Light</u> : photodiode	Thermocouple
Measuring range	Measuring range of the internal sensor ³ : From -40 to +70°C	Measuring range of the internal sensor ³ : <u>Temperature</u> : from -20 to +70°C <u>Humidity</u> : from 0 to 100 % RH <u>Light</u> : from 0 to +10 000 lux	K: from -200 to +1300°C J: from -100 to +750°C T: from -200 to +400°C N: from -200 to +1300°C S: from 0 to 1760°C
Accuracies⁴	±0.4°C from -20 to 70°C ±0.8°C below -20°C	<u>Temperature</u> : ±0.4°C from 0 to 50°C ±0.8°C below 0°C or above 50°C <u>Humidity</u> ⁵ : ±2%RH from 5 to 95%RH from 15°C to 25°C <u>Light</u> : ±10% of reading +10 lux	K, J, T, N: ±0.4°C from 0 to 1300°C ±(0.3% of reading +0.4°C) below 0°C S: ±0.6°C
Setpoint alarms	2 setpoint alarms on each channel		
Frequency of measurement	From 1 second to 24 hours		
Operating temperature	From -40 to +70°C	From -20 to 70°C	From -20 to 70°C
Storage temperature	From -40 to +85°C		
Battery life	4 years ⁶		
European directives	2011/65/EU RoHS II; 2012/19/EU WEEE; 2014/30/EU EMC; 2014/35/EU		

¹ Some units are available only with optional probes.

² Input which allows to plug different compatible probes: see optional probes and cables page 8.

³ Other measuring ranges are available according to the connected probe: see optional probes and cables page 8.

⁴ All accuracies indicated in this document were stated in laboratory conditions and can be guaranteed for measurement carried out in the same conditions, or carried out with calibration compensation.

⁵ Factory calibration uncertainty: ±0.88%RH. Temperature dependence: ±0.04 x (T-20) %RH (if T<15°C or T>25°C)

⁶ On the basis of 1 measurement each 15 minutes at 25°C.

3.2 Features of the housing

Dimensions	93.2 x 65.2 x 30.5 mm
Weight	115 g
Display	2 lines LCD screen (for models with display) Screen size: 39 x 34 mm 2 indication LEDs (red and green)
Control	1 OK key 1 Selection key
Material	Compatible with food industry environment ABS housing
Protection	IP 65: KT 220 IP 54: KTT 220* IP 40: KH 220
PC communication	Female micro-USB connector USB cable
Battery power supply	1 AA lithium 3.6 V battery
Environmental conditions of use	Air and neutral gases Hygrometry: in non-condensing condition Maximum altitude: 2000 m

* With all the thermocouple probes connected.

3.3 Optional probes and cables

Reference	Description	Measuring range
<i>Temperature and humidity probe</i>		
KTHA	Interchangeable hygrometry and ambient temperature probe	Hygrometry: from 0 to 100%RH Temperature: from -20 to +70°C
KTHD	Remote interchangeable hygrometry and temperature probe	
<i>NTC Temperature probe</i>		
KSI-50 / KSI-150	IP65 immersion probe	From -40 to +120°C
KSA-150	Ambient use probe	From -40 to +120°C
KSF-2	Wire probe	From -20 to 100°C
KSP-150	IP68 penetration probe	From -40 to +120°C
KSP-150	IP65 penetration probe	From -40 to +120°C
KCV-220	Probe with velcro	From -20 to +90°C
<i>Current and voltage input cables and pulse input cable</i>		
KCTD-10-B	Voltage input cable	0-5 V or 0-10 V
KCCD-02-B	Current input cable	0-20 mA or 4-20 mA
KCTD-I-B	Pulse input cable	Maximal voltage: 5 V Type of input: TTL frequency counting Maximal frequency: 10 kHz Maximum number of recordable points: 20 000 points
<i>Ammeter clamps</i>		
KPID-50-BRF	Ammeter clamp from 0 to 50 A, frequency range from 40 to 5000 Hz	From 0 to 50 A _{AC}
KPID-100-BRF	Ammeter clamp from 0 to 100 A, frequency range from 40 to 5000 Hz	From 1 to 100 A _{AC}
KPID-200-BRF	Ammeter clamp from 0 to 200 A, frequency range from 40 to 5000 Hz	From 1 to 200 A _{AC}
KPID-600-BRF	Ammeter clamp from 0 to 600 A, frequency range from 40 to 5000 Hz	From 1 to 600 A _{AC}
<i>Relative pressure probe (water probe)</i>		
KSPE	Relative pressure probe for liquids and gases (corrosive)	From 0 to 10 bars
KSPE-2	Relative pressure probe for liquids and gases (corrosive)	From 0 to 20 bars
<i>Thermocouple probes</i>		
For more details about the available thermocouple probes, please see the "Thermocouple probes" datasheet.		

For more details, please see the "Measuring probes for KISTOCK class 220" and "Thermocouple probes" datasheets.

Connect a probe:

- Open the mini-DIN connection cap on the bottom of the KISTOCK.
- Connect the probe in such a way the mark on the probe is in front of the user.

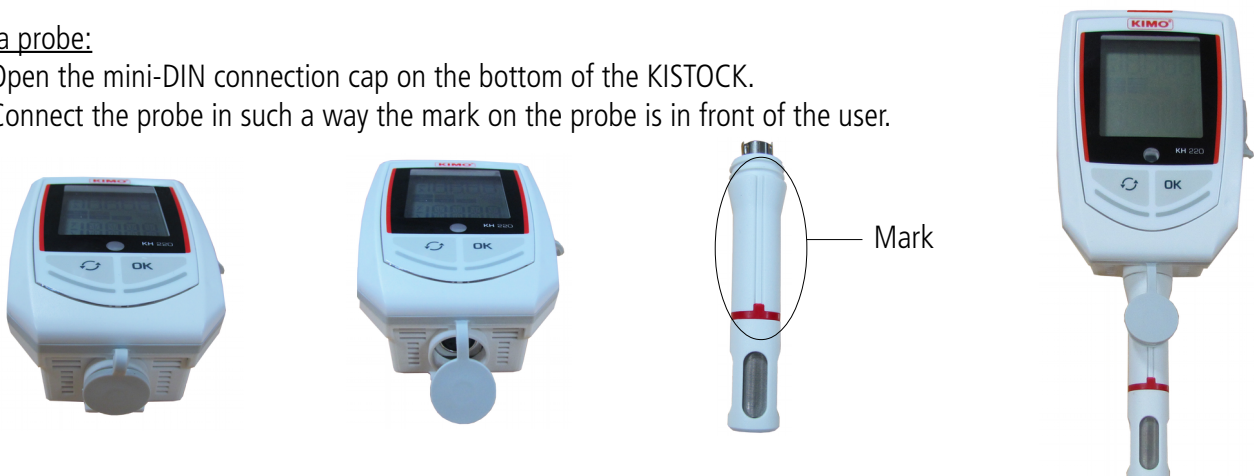

3.4 Dimensions (in mm)

3.4.1 Devices

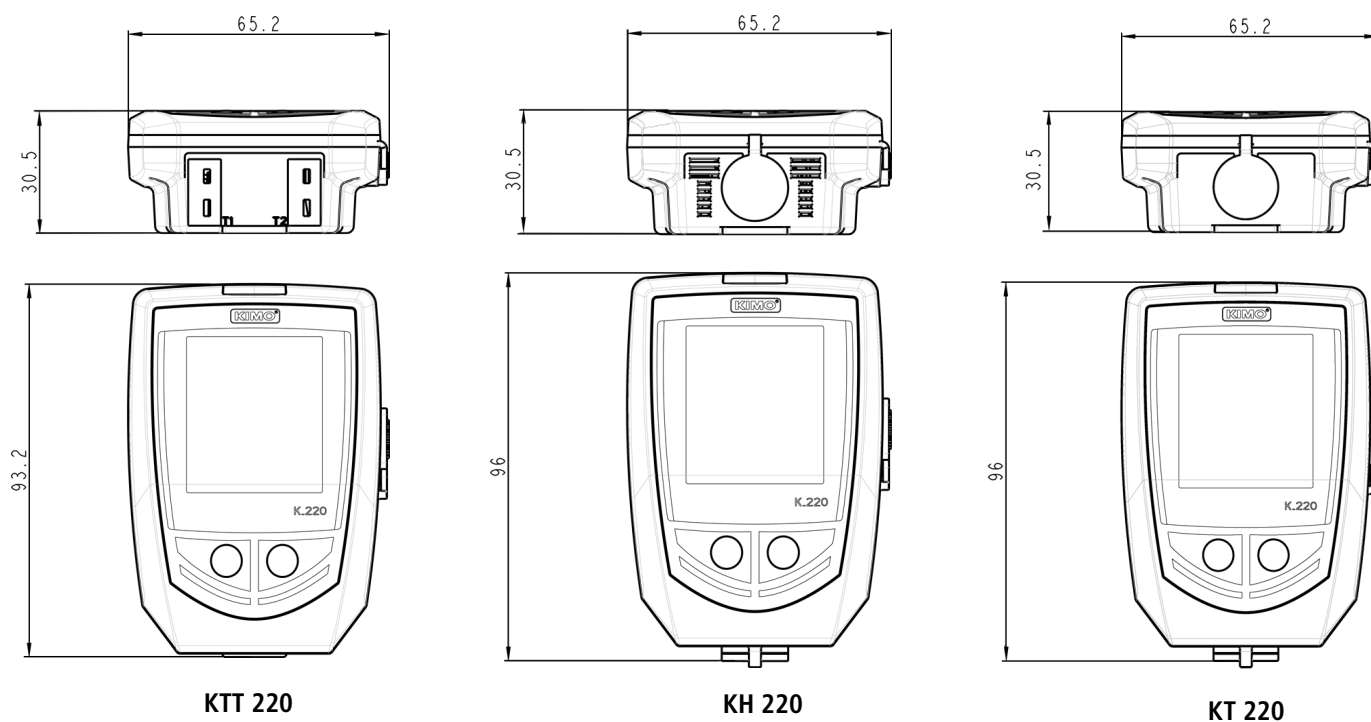

3.4.2 Wall mount

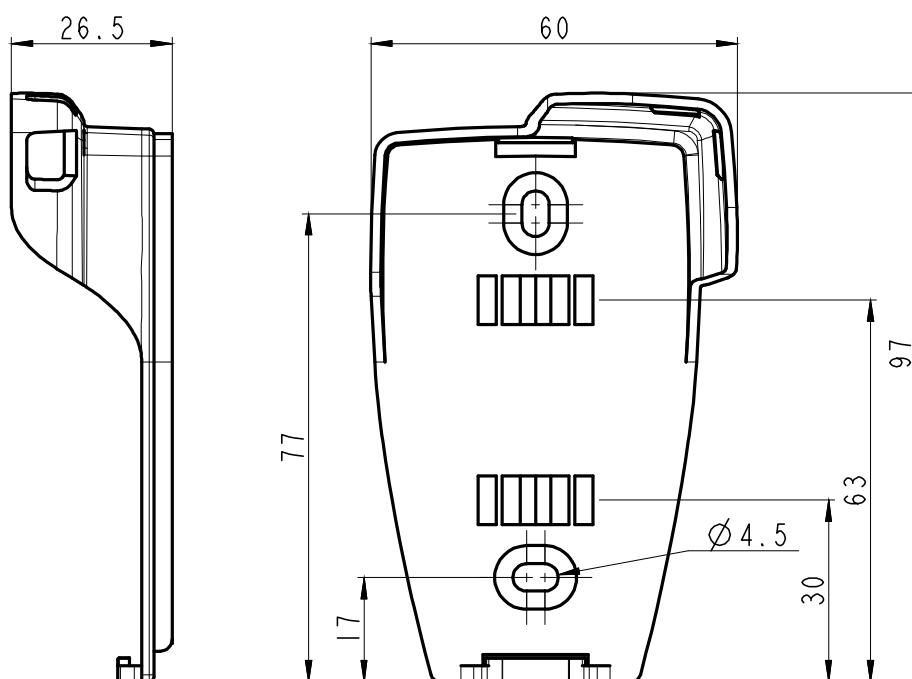

3.5 Guarantee period

KISTOCK dataloggers have 1-year guarantee for any manufacturing defect (return to our After-sales service required).

4.1 Display

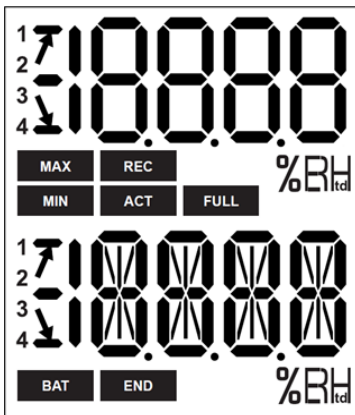

- END** DATASET is finished.
- REC** Indicates that one value is being recorded.
It flashes: the DATASET did not start already.
- FULL** Flashing slowly: DATASET is between 80 and 90 % of the storage capacity.
Flashing quickly: DATASET is between 90 and 100 % of the storage capacity.
Constant: storage capacity full.
- BAT** Constant: indicates that the batteries have to be replaced.
- ACT** Screen actualization of measured values.
- MIN**
- MAX** The displayed values are the maximum/minimum values recorded for the channels displayed.
- Indication of the direction of exceeding the threshold in the recorded measurement
- Indication of the direction of exceeding the threshold in the recorded measurement
- °C** Temperature in °Celsius.
- °F** Temperature in °Fahrenheit.
- %RH** Relative humidity (KH 220).

- 1**
- 2** Indicates the channel number which is
- 3** measuring.
- 4**

- The selected values to display during the configuration with the KILOG software will scroll on the screen every 3 seconds.
- The display can be activated or deactivated via the KILOG software.
- At extreme temperatures, the display can become hardly readable and its display speed can slow down at temperatures below 0°C. This has no incidence on the measurement accuracy.

4.2 Functions of LEDs



Alarm LED

Operating LED

- If the red "Alarm" LED has been activated, it has 3 states:
- **Always OFF:** no setpoint alarms has been exceeded
 - **Flashing quickly (5 seconds):** a threshold is currently exceeded on one channel at least
 - **Flashing slowly (15 seconds):** at least one threshold has been exceeded during the dataset

If the green "ON" LED has been activated, it flashes every 10 seconds during the recording period.













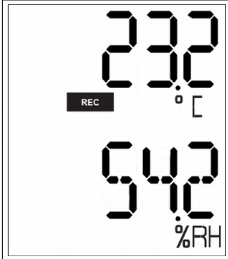

4.3 Functions of keys

OK

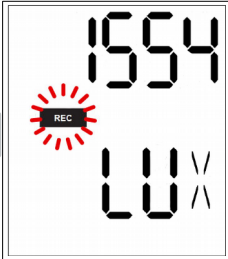
OK key: allows to start, stop the dataset or change of scrolling group like described in the following tables.

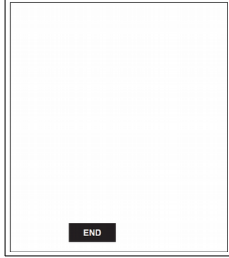
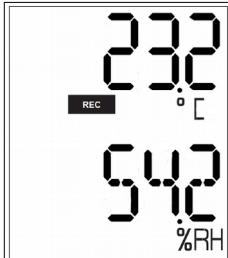
↻

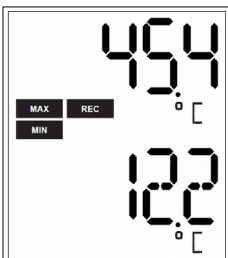

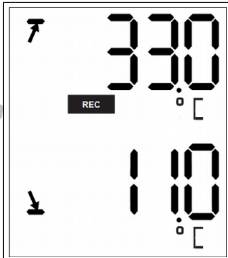

Selection key: allows the scroll values in the scrolling group like described in the following tables.

Device state	Type of start/stop	Key used	Action generated	Illustration
	Start: by key	OK During 5 seconds	Dataset starting	  During 5 seconds
	Stop: indifferent	OK	Inactive	
Waiting for start	Start by PC, date / time	OK	Inactive	
	Stop: indifferent			 flashes
	Start: indifferent	↻	Measurements scrolling (group 1)*	 
	Stop: indifferent			 
Dataset in progress	Start: indifferent	OK	Dataset stop	  
	Stop: indifferent	OK	Group change (groups 2 and 3)*	    

* Please see the summary table of the groups organisation on page 14.

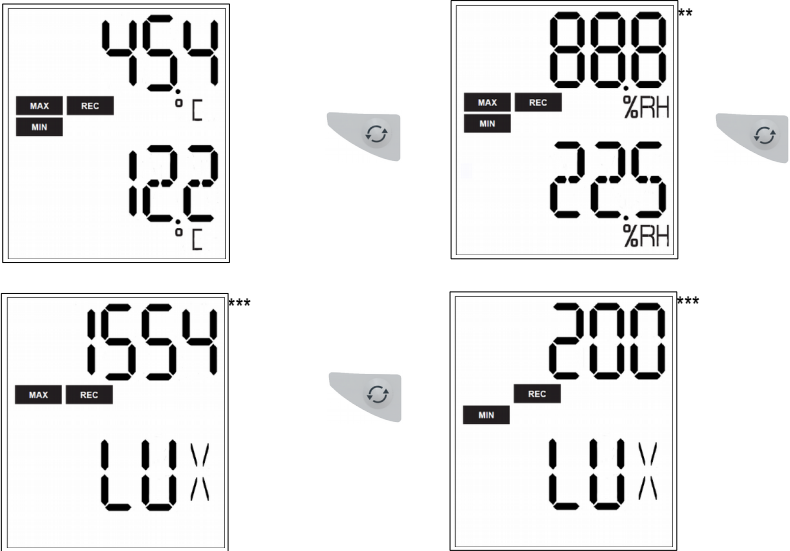
** %RH: only the KT 220 and KH 220.

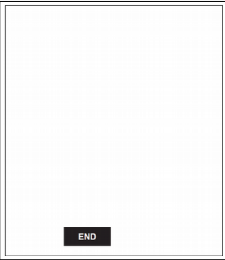
*** Lux: only the KH 220.

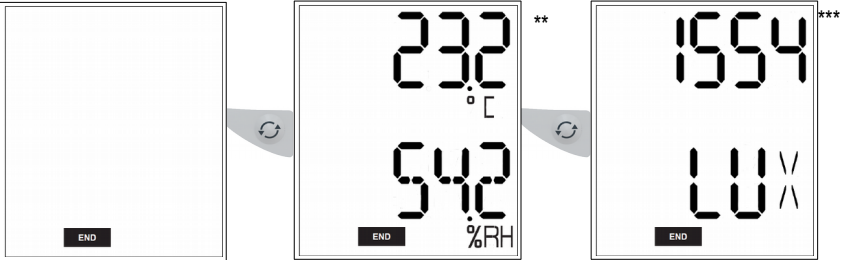
Device state	Type of start/stop	Key used	Action generated	Illustration
	Start: indifferent			
	Stop: indifferent		Group scrolling (groups 1, 2 and 3)*	
Dataset finished	Indifferent		Inactive	
END	Indifferent		Measurements scrolling*	











* Please see the summary table of the groups organisation page 13.

** %RH: only the KT 220 and KH 220.

*** Lux: only the KH 220.

4.3.1 Groups organisation

The table below summarises the groups organisation and measured values available during a measurement dataset.

	Group 1	Group 2	Group 3
 	Measured temperature	Max. value in temperature Min. value in temperature	High alarm threshold in temperature Low alarm threshold in temperature
 	Measured hygrometry*	Max. value in hygrometry Min. value in hygrometry	High alarm threshold in hygrometry. Low alarm threshold in hygrometry.
 	Measured light*	Max. value in light Min. value in light	High alarm threshold in light Low alarm threshold in light
 	Probe 1 measured parameter*	Max. value for probe 1 Min. value for probe 1	High alarm threshold for probe 1 Low alarm threshold for probe 1
 	Probe 2 measured parameter*	Max. value for probe 2 Min. value for probe 2	High alarm threshold for probe 2 Low alarm threshold for probe 2

Press  key to change of group.

Press  key to scroll the values in the group.

4.3.2 Measurements scroll

According to the selected parameters during the configuration and according to the type of device, the measurement scroll is carried out like following:

Temperature ➡ Hygrometry* ➡ Light* ➡ Parameter 1 of probe* ➡ Parameter 2 of probe*

4.4 PC communication

- Insert the CD-ROM in the reader and follow the installation procedure of the **KILOG** software.
 1. Plug the male USB connector of the cable to an USB connection on your computer**.
 2. Open the USB cap on the right side of the datalogger.
 3. Connect the male micro-USB connector of the cable to the female micro-USB connector of the device.



4.5 Configuration, datalogger download and data processing with the KILOG software

Please see the **KILOG** software user manual: "**KILOG-classes-50-120-220-320**".



The date and time updates automatically when a new configuration is loaded.

* Parameters available according to the device and probe type

** The computer must be in compliance with the IEC60950 compliance.

5.1 Replace the battery

With 4 years* battery life, KISTOCK guarantees long-term measurement.
The **BAT** icon appears when the battery has to be replaced.

To replace the battery:

1. Unscrew the 4 screws on the back side of the device with a screwdriver.
 2. Remove the back side and the old batteries.
 3. Insert the new battery and respect the polarity.
- Replace the back side and screw it.

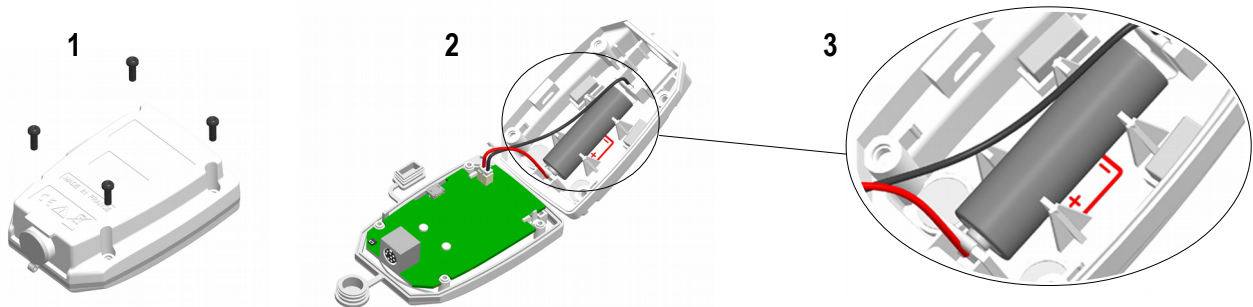

 Only use trademark or high quality batteries in order to guarantee the announced autonomy.

 After the battery replacement, the device must be reconfigured.

5.2 Device cleaning

Please avoid any aggressive solvent.

Please protect the device and probes from any cleaning produce containing formalin, that may be used for cleaning rooms and ducts.

5.3 Safety lock wall mount with padlock

- Mount the safety lock support on the required place.
1. Present the KISTOCK datalogger on the support **starting with the inferior part**
 2. Clip the KISTOCK on the support by falling back the superior part
 3. Insert the padlock to ensure the safety lock function



- To remove the datalogger from the support, proceed on reverse order.





 The padlock can be replaced by a fail-safe sealed

 The datalogger can be placed on the screw-mount without the safety lock function

* On the basis of 1 measurement each 15 minutes at 25°C.

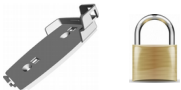
A calibration certificate is available as option in paper format.
We recommend to carry out a yearly checking.

7 Accessories

Accessories	References	Illustrations
1 AA lithium 3.6 V	KBL-AA	
Safety lock wall mount with padlock	KAV-220	
Wired extension for class 220 KISTOCK probes In polyurethane, 5 m length with male and female mini-DIN connectors <u>Note:</u> several extensions can be wired in order to obtain up to 25 m cable length	KRB-220	
KILOG software: Configuration and data processing software KILOG software allows to configure, save and process your data in a very simple way.	<u>Software only:</u> KILOG-3-N <u>Complete set</u> (software + 1 USB cable): KIC-3-N	
Data collector Collects up to 20 000 000 points from one or several KISTOCK directly on-site. Results restitution on PC of realised datasets	KNT-320	
USB micro-USB cable which allows to plug your KISTOCK datalogger to your PC	CK-50	

 Only the accessories supplied with the device must be used.

8 Troubleshooting

Problem	Probable cause and possible solution
No value is displayed, only the icons are present.	The display is configured on "OFF". Configure it on "ON" with the KILOG software (see page 13).
"hi" or "lo" is displayed	The measurement range is exceeded. There is a problem with the sensing element.
The display is completely off* and there is no communication with the computer.	The battery has to be replaced. (see page 14).
The display indicates "- - -" instead of the measured value.	The probe is disconnected. Plug it again to the datalogger.

* For models with display.