

Thank you very much for purchasing Panasonic products. Please read this Instruction Manual carefully and thoroughly for the correct and optimum use of this product. Kindly keep this manual in a convenient place for quick reference.

WARNING

- Never use this product as a sensing device for personnel protection.
- In case of using sensing devices for personnel protection, use products which meet laws and standards, such as OSHA, ANSI or IEC etc., for personnel protection applicable in each region or country.

1 INTENDED PRODUCTS FOR CE MARKING

- This product complies with the following standards / regulations.

<EU Directive>
EMC Directive



Contact for CE

Panasonic Marketing Europe GmbH Panasonic Testing Center
Winsbergring 15, 22525 Hamburg, Germany

2 PART DESCRIPTION

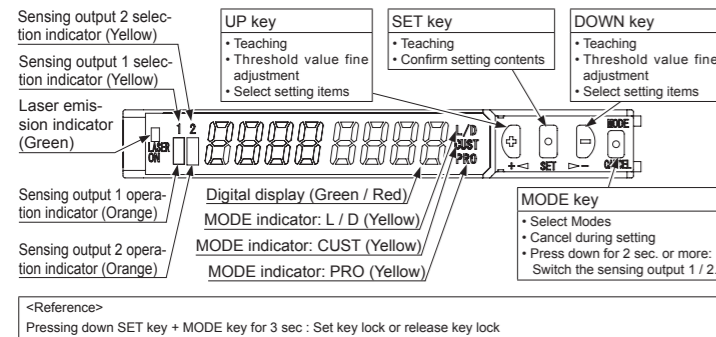

3 MOUNTING

How to connect

1. Fit the rear part of the mounting section of the amplifier on a DIN rail.
2. Press down the rear part of the mounting section of the unit on the DIN rail and fit the front part of the mounting section to the DIN rail.

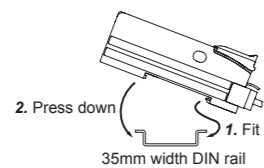

How to remove

1. Push the controller forward.
2. Lift up the front part of the amplifier to remove it.

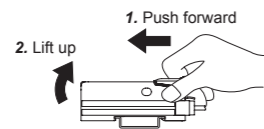

4 CONNECTION OF A SENSOR HEAD

Make sure that the power supply is OFF while connecting or disconnecting the sensor head LS-H series (optional).

How to connect

1. Insert the connector of the sensor head LS-H series (optional) into the connector area for the sensor head of this product as shown in the right figure.
2. Fit the connector cover.

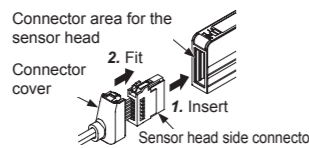

How to remove

1. Pressing the release lever attached to the connector of the sensor head, pull out the connector.

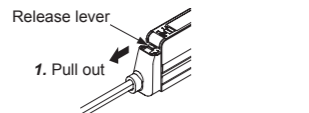

Note: Do not pull by holding the cable without pressing the release lever, as this can cause cable break or connector break.

<Terminal arrangement>

Terminal No.	Color code
1	Purple
2	White
3	Shield
4	Shield
5	Black
6	Pink

5 INSTALL MORE AMPLIFIER OF SERIES CONNECTION TYPE

- Make sure that the power supply is OFF while adding or removing the series connection type.
- In case 2 or more the series connection types are connected in cascade, make sure to mount them on a DIN rail.
- In case installing additional amplifier of series connection type, the maximum 11 the series connection types using sub cables can be added to an amplifier using a main connection cable.
- When connecting 2 or more the series connection types in cascade, use the sub cable (optional) for the second series connection type onwards.

For mounting and removing the amplifier, refer to "3 MOUNTING."

How to cascade

1. Mount the amplifiers, one by one, on the DIN rail.
2. Slide the amplifiers next to each other, and connect the quick-connection cables.
3. Mount the end plates MS-DIN-E (optional) at both the ends to hold the amplifiers between their flat sides.
4. Tighten the screws to fix the end plates.

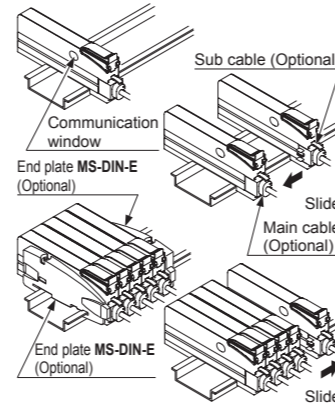

How to Remove

1. Loosen the screws of the end plates.
2. Remove the end plates.
3. Slide the amplifiers and remove them one by one.

6 I/O CIRCUIT DIAGRAMS

<LS-501>

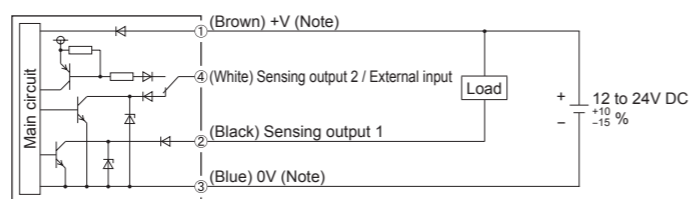

<LS-501P>

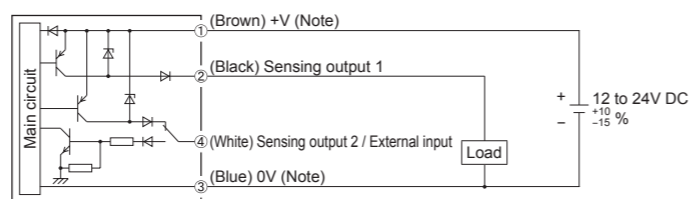

Note: The quick-connection sub cable does not incorporate +V (brown) and 0V (blue). The power is supplied from the connector of the main cable.

<Terminal arrangement>

Terminal No.	Terminal name
1	+V
2	Sensing output 1
3	0V
4	Sensing output 2 / External input

7 OPERATION PROCEDURE

- The sensing output can be switched to sensing output 1 or sensing output 2 by holding down the mode key.
- The changed settings are not stored if turning the power OFF while setting. Therefore, confirm the settings by pressing the SET key before turning the power OFF.

- When turning ON the power, RUN mode is displayed and the digital display shows the threshold value (green) and the incident light intensity (red).

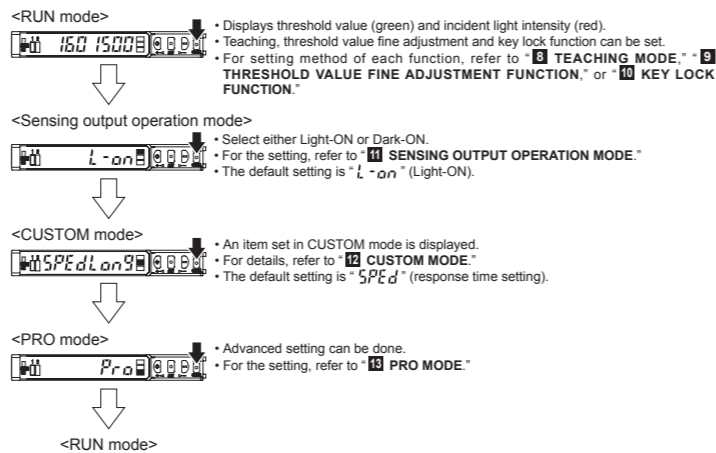

8 TEACHING MODE

- Be sure that detection may become unstable depending on the use environment in teaching if less margin is applied.
- When teaching in Window comparator mode or Hysteresis mode, a setting has to be made in PRO mode beforehand. In case 1-point teaching, make sure to set the shift amount. (initial value is 10% or 100) For the setting, refer to <PRO6> in "4 PRO MODE OPERATION DESCRIPTION."

- Teaching can be set in RUN mode.

Useful when sensing object can be set

2-point teaching This is basic teaching method.

<Thru-beam type> **<Retroreflective type>** **<Diffuse reflective type>**

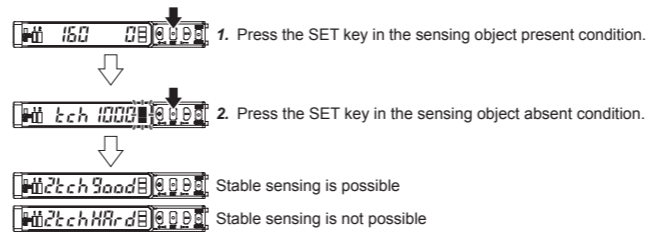
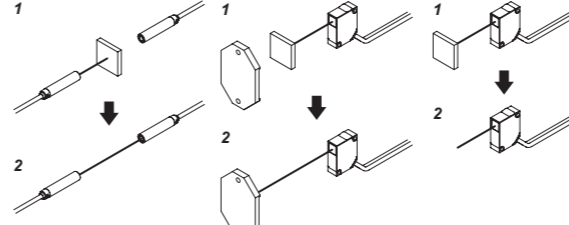

Useful when sensing object cannot be set

Limit-teaching This is teaching method in case small object or object in background are existing.

<Thru-beam type and retroreflective type, diffuse reflective type are common>

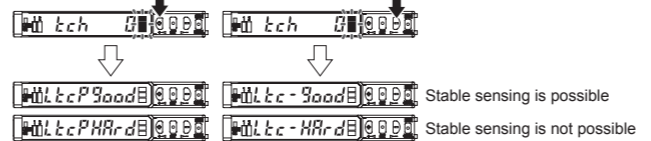
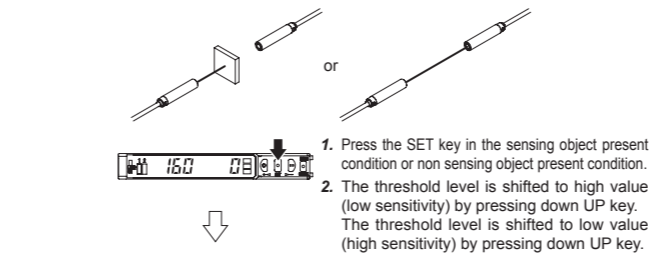

Note: The shift value of approx. 15% is an initial value. Display of the shift value can be changed to percentage [approx. 0 to 99% (unit 1 %)] or incident light intensity [0 to 999 (unit 1)]. For setting the shift amount, refer to <PRO1> in "4 PRO MODE OPERATION DESCRIPTION."

Useful when not want to stop production line and to keep the sensing object move

Full-auto teaching This is method to conduct teaching doing sensing object is moving.

<Thru-beam type and retroreflective type, diffuse reflective type are common>

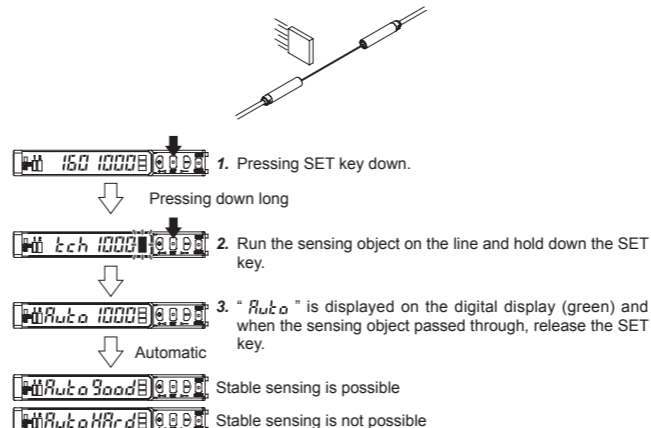

1-point teaching (Window comparator mode / Hysteresis mode)

- This is method to set the shift amount to the desired value and to set the threshold range by using the 1-point teaching.

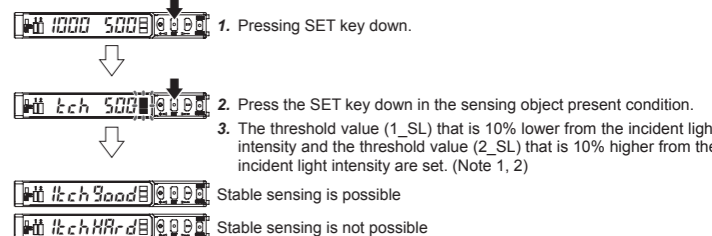
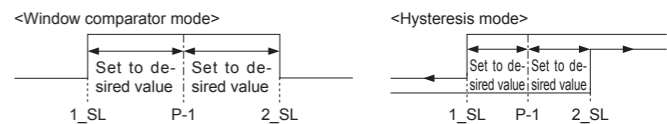

Notes 1) The shift amount of 10% is an initial value. The shift amount can be set in PRO mode. Furthermore, the shift value can be set in incident light amount. For setting method, refer to <PRO6> in "4 PRO MODE OPERATION DESCRIPTION."
2) If the value after setting exceeds the maximum (minimum), the maximum (minimum) sensitivity will be set.

2-point teaching (Window comparator mode / Hysteresis mode)

- This is method to set the threshold range by conducting the 2-point teaching (P-1, P-2).
- When conducting teaching, use sensing objects (P-1 and P-2) whose incident light intensities are different from each other.

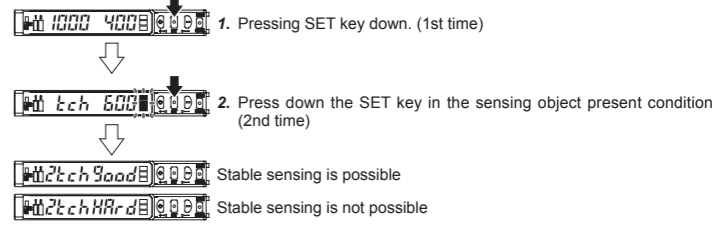
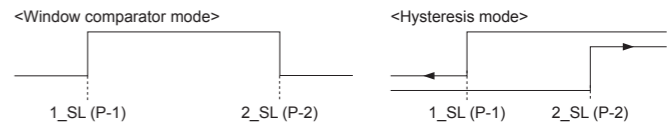

Note: If the value after setting exceeds the maximum (minimum), the maximum (minimum) sensitivity will be set.

3-point teaching (Window comparator mode / Hysteresis mode)

- This is the method to conduct the 3-point teaching (P-1, P-2, P-3) and to set the threshold range by setting the threshold value (1_SL) of the mid-point between "A" and "B" and the threshold value (2_SL) of the mid-point between "B" and "C".
- When conducting teaching, use sensing objects (A, B and C) whose incident light intensities are different.
- After teaching, P-1, P-2 and P-3 will be automatically relocated in ascending order: i.e. the lowest value is placed in "A", the second lowest in "B" and the highest in "C".

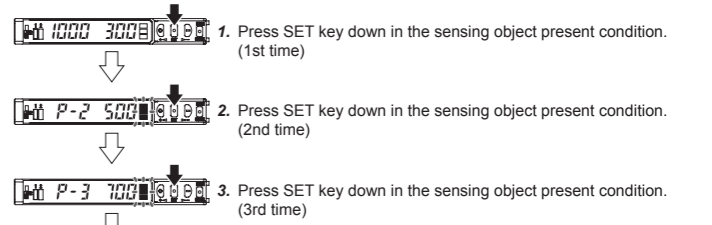
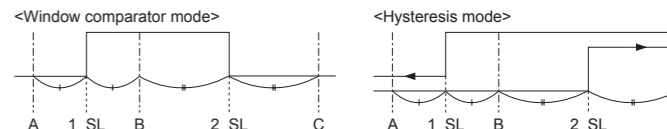

Span adjustment in rising differential mode or trailing differential mode

- Move to the rising differential mode, or the trailing differential mode in the PRO mode, and press the jog switch to confirm the setting. For the setting procedure, refer to <PRO6> in "4 PRO MODE OPERATION DESCRIPTION."
- The threshold can be set by using the threshold value fine adjustment function. For the threshold value fine adjustment function, refer to "4 THRESHOLD VALUE FINE ADJUSTMENT FUNCTION."

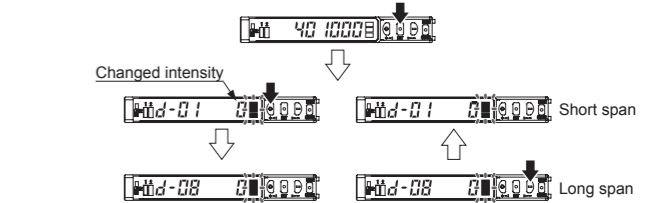

9 THRESHOLD VALUE FINE ADJUSTMENT FUNCTION

- Set the fine adjustment of threshold value in RUN mode.
- Also, the threshold value fine adjustment function can be used in forced ON output mode and forced OFF output mode.
- For setting of the sensing output, refer to <PRO6> in "19 PRO MODE OPERATION DESCRIPTION."

<Normal mode, Rising differential mode or Trailing differential mode>

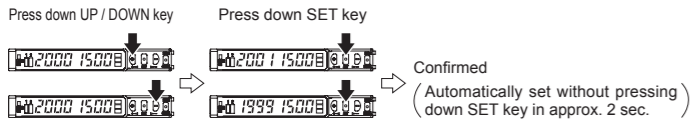

<Window comparator mode or Hysteresis mode>

- When setting sensing output to the window comparator mode or hysteresis mode, "1.5L" and "2.5L" can be changed to another by pressing down SET key for 2 sec.
- In case conducting threshold value fine adjustment of "1.5L" or "2.5L", press down UP key or Down key, and "1.5L" or "2.5L" are displayed. Then, the threshold value fine adjustment can be conducted.

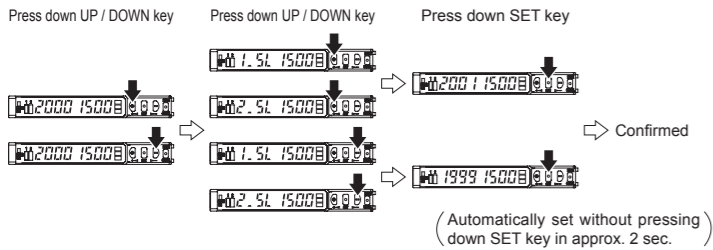

Note: It may not respond when values of "1.5L" and "2.5L" are close because of relation of hysteresis. Be sure to confirm with this device.

10 KEY LOCK FUNCTION

- The key lock function prevents key operations so that the conditions set in each setting mode are not inadvertently changed.
- If operating key switch after key lock is set, "Loc on" is indicated on the digital display.

<Set key lock>

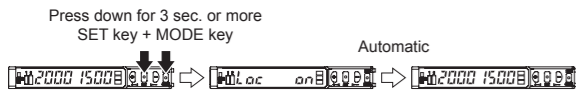

<Release key lock>

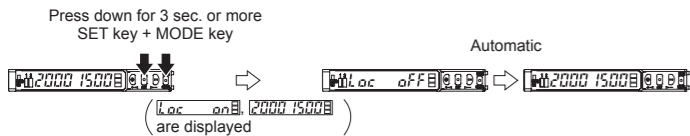

11 SENSING OUTPUT OPERATION MODE

- When MODE indicator: L / D (yellow) lights up, sensing output operation can be set.

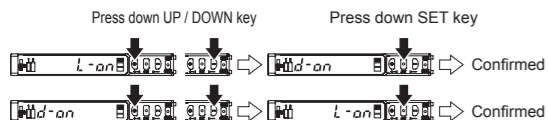

12 CUSTOM MODE

- When MODE indicator: CUST (yellow) lights up, Response time setting, Emission power setting or Hysteresis setting can be displayed.
- For the setting procedure, refer to <PRO5> in "19 PRO MODE OPERATION DESCRIPTION."
- By pressing UP key or DOWN key, the setting in each item will be changed.
- Press SET key to confirm the setting.
- For setting of each item, refer to the following table.

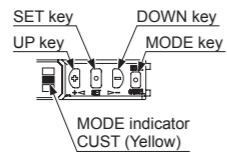

Item	Digital display	Reference item
Response time setting	5PEdLan9	<PRO 1: Response time setting>
Light-receiving sensitivity setting	9cLl "" "" ""	<PRO1: Light-receiving sensitivity setting>
Emission halt setting	HEPd on	<PRO1: Emission halt settings>
Data bank loading setting	chLg lDch	<PRO3: Data bank loading setting>
Code setting	00300030	<PRO5: Code setting>
Hysteresis setting	HY5H-02	<PRO 1: Hysteresis setting>

13 PRO MODE

- When MODE indicator: PRO (yellow) lights up, PRO mode can be set.
- For detail of PRO mode, refer to "19 PRO MODE OPERATION DESCRIPTION."

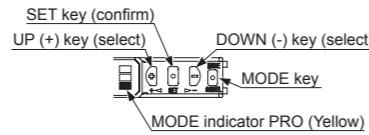

Procedure

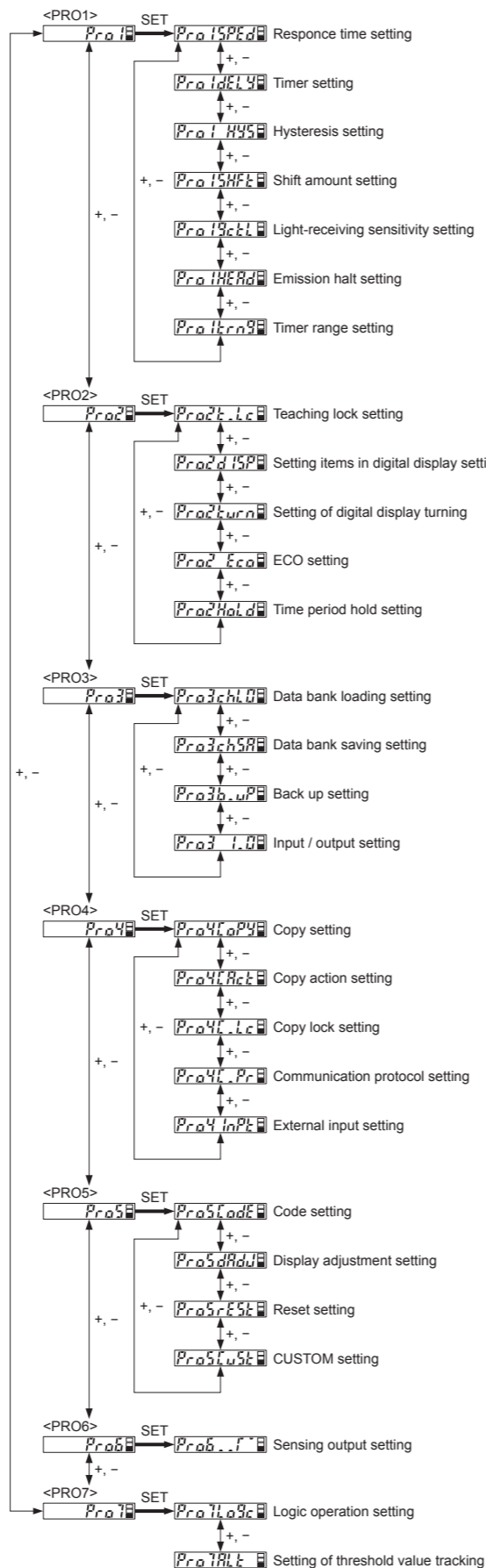

14 OPTICAL COMMUNICATION

- When the setting of data bank loading / saving, copy setting, or copy action setting is conducted via optical communications, cascade the sub amplifiers right side to the main amplifier as follows.
- However, in case using data bank loading / saving, use LS-501 or LS-501-C2 as main amplifier.
- If an amplifier is under any of the following conditions, the setting of data bank loading / saving, or copy setting cannot be carried out.
 - Copy lock setting is set to copy lock ON "L.Lc on."
 - Digital display is blinking
 - External input setting of main amplifier is set to "inpL 5ELF." (Only databank loading / saving)
- When communication protocol of a sub amplifier is set to communication emission halt "L.Pr OFF" the setting of data bank loading / saving, or copy setting cannot be carried out to sub amplifiers subsequent to the mentioned amplifier.
- Make sure to mount closely like follows since interference prevention function is conducted by optical communication.

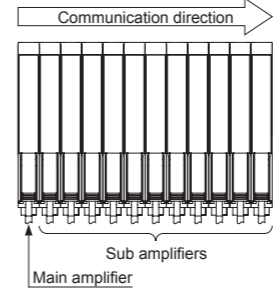

- When this product and other products (e.g. fiber sensor amplifiers, pressure sensor controllers, etc.) are connected together in cascade, install those products so that they are in order of Group A, B, D and C as shown in the right figure. This product is included in Group D.

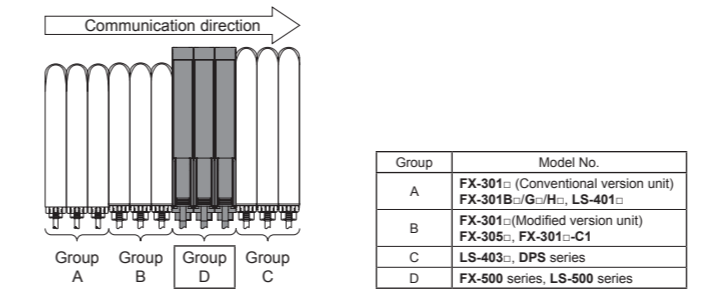

- Within each group, identical models should be connected in a lump.
- In case conducting copy setting of this device and other LS-500 series together, functions which are incorporated in this device will be copied but functions which are not incorporated in this device will not be copied.

15 INTERFERENCE PREVENTION FUNCTION

- Possible number of amplifiers for interference prevention function is different as shown in table below.

Response time	H-SP	FAST	STD	LONG	U-LG	HYPR
Number of amplifiers	0	2	4	4	4	4

- In case putting in more amplifiers than limit of interference prevention function, put the amplifier protection seal to amplifier which is adjacent of end of an amplifier that the interference function is valid or set OFF in communication protocol setting of the end of amplifier that the interference prevention function is valid.
- **Example: Putting in 12 of this device and set STD of response time setting.**
 - Possible number of interference prevention is 4.
 - Put the amplifier protection seals 4th and 5th amplifiers and between 8th and 9th amplifiers or change the communication protocol setting of 4th and 8th to OFF since interference prevention works from 1st to 4th, from 5th to 8th and 9th to 12th.

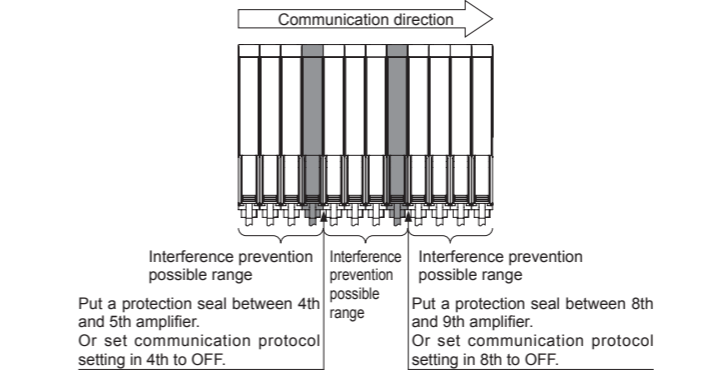

- In case mounting more amplifiers whose response time setting are different, put protection seal between amplifiers that have different response time setting or set communication protocol setting of the upper amplifier to OFF.
- For communication protocol setting procedure, refer to <PRO4> in "19 PRO MODE OPERATION DESCRIPTION."

16 ERROR INDICATION

- In case of errors, attempt the following measures.

Error indication	Description	Remedy
Er01	EEPROM is broken or reached the end of its working life.	Please contact our office.
Er02	EEPROM writing error	
Er11	Load of the sensing output 1 is short-circuited causing an over-current to flow.	Turn OFF the power and check the load.
Er12	Load of the sensing output 2 is short-circuited causing an over-current to flow.	
Er42	Fault error of sensor head.	Check the connection of sensor head. If the error persists despite checking the connection, please contact us.
Er52	Communication error when the amplifiers are mounted in cascade.	Verify that there is no loose or clearance between amplifiers.
Er53	Communication error between the upper communication unit and amplifiers.	Verify that there is no loose or clearance between the upper communication unit and amplifiers.

17 SPECIFICATIONS

Type	Series connection type	
	NPN output	PNP output
Model No.	LS-501	LS-501P
Supply voltage	12 to 24V DC $\pm 10\%$ Ripple P-P10% or less	
Power consumption	Normal operation: 1.200mW or less (current consumption 50mA or less at 24V supply voltage) Eco mode: 980mW or less (current consumption 40mA or less at 24V supply voltage)	
Sensing output (Sensing output 1 / 2)	NPN open-collector transistor • Maximum sink current: 50mA (Note 1) • Applied voltage: 30V DC or less (Between sensing output and 0V) • Residual voltage: 2V or less (Note 2) [At 50mA (Note 1) sink current]	PNP open-collector transistor • Maximum source current: 50mA (Note 1) • Applied voltage: 30V DC or less (Between sensing output and +V) • Residual voltage: 2V or less (Note 2) [At 50mA (Note 1) source current]
Output operation	Switchable either Light-ON or Dark-ON	
Short-circuit protection	Incorporated	
Response time	H-SP: 60µs or less, FAST: 150µs or less, STD: 250µs or less, LONG: 500µs or less U-LG: 5ms or less, HYPR: 24ms or less, Selectable	
External input	• Signal condition High: +8V to +V DC or Open Low: 0 to +1.2V DC (at 0.5mA source current) • Input impedance: Approx. 10kΩ	• Signal condition High: +4V to +V DC (at 3mA sink current) Low: 0 to +0.6V DC or Open • Input impedance: Approx. 10kΩ
Protection	IP40 (IEC)	
Ambient temperature	-10 to +55°C (If 4 to 7 units are mounted in cascade: -10 to +50°C or if 8 to 16 units are mounted in cascade: -10 to +45°C) (No dew condensation or icing allowed) Storage: -20 to +70°C	
Ambient humidity	35 to 85% RH, Storage: 35 to 85% RH	
Material	Enclosure: Polycarbonate, Key: Polyacetal, Protective cover: Polycarbonate	
Weight (Main body only)	Approx. 15g	
Accessory	FX-MB1 (Amplifier protection seal): 1 set.	

Notes: 1) 25mA max. if 5 or more series connection types are connected together.
2) In case of using the quick-connection cable (cable length 5m) (optional).
3) Cables are not accessories. Be sure to use cables in table below.

<Series connection type>

	Cable					
	Cable length 1m		Cable length 2m		Cable length 5m	
	Main cable	Sub cable	Main cable	Sub cable	Main cable	Sub cable
LS-501	CN-74-C1	CN-72-C1	CN-74-C2	CN-72-C2	CN-74-C5	CN-72-C5

18 CAUTIONS

- This product has been developed / produced for industrial use only.
- Make sure that the power supply is OFF while adding or removing the amplifiers.
- Take care that if a voltage exceeding the rated range is applied, or if an AC power supply is directly connected, the product may get burnt or be damaged.
- Take care that short-circuit of the load or wrong wiring may burn or damage the product.
- Do not run the wires together with high-voltage lines or power lines, or put them in the same raceway. This can cause malfunction due to induction.
- The specification may not be satisfied in a strong magnetic field.
- Verify that the supply voltage variation is within the rating.
- If power is supplied from a commercial switching regulator, ensure that the frame ground (F.G.) terminal of the power supply is connected to an actual ground.
- In case noise generating equipment (switching regulator, inverter motor, etc.) is used in the vicinity of this product, connect the frame ground (F.G.) terminal of the equipment to an actual ground.
- The ultra long distance (U-LG, HYPR) mode is more likely to be affected by extraneous noise since the sensitivity of that is higher than the other modes. Make sure to check the environment before use.
- Do not use during the initial transient time (H-SP, FAST, STD: 0.5 sec., LONG, U-LG, HYPR: 1 sec.) after the power supply is switched ON.
- Extension up to total 100m is possible. However, in order to reduce noise, make the wiring as short as possible. When you extend the cable, be sure to use cables which have 0.3mm² or more of conductor cross-section area. Set the power supply voltage while taking into account the voltage drop in the power cable due to its resistance.
- Make sure that stress by forcible bend or pulling is not applied to the sensor cable joint.
- This product is suitable for indoor use only.
- Avoid dust, dirt, and steam.
- Take care that the product does not come in contact with oil, grease, organic solvents such as thinner, etc., strong acid or alkaline.
- This product cannot be used in an environment containing inflammable or explosive gasses.
- Never disassemble or modify the product.
- This product adopts EEPROM. Settings cannot be done 100 thousand times or more because of the EEPROM's lifetime.

19 PRO MODE OPERATION DESCRIPTION

Part description

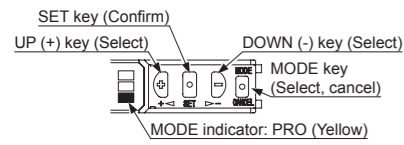

Symbol explanation

- SET: Press the SET key
- +/-: Press the UP (+) key or DOWN (-) key
- Automatic: Automatically move to next

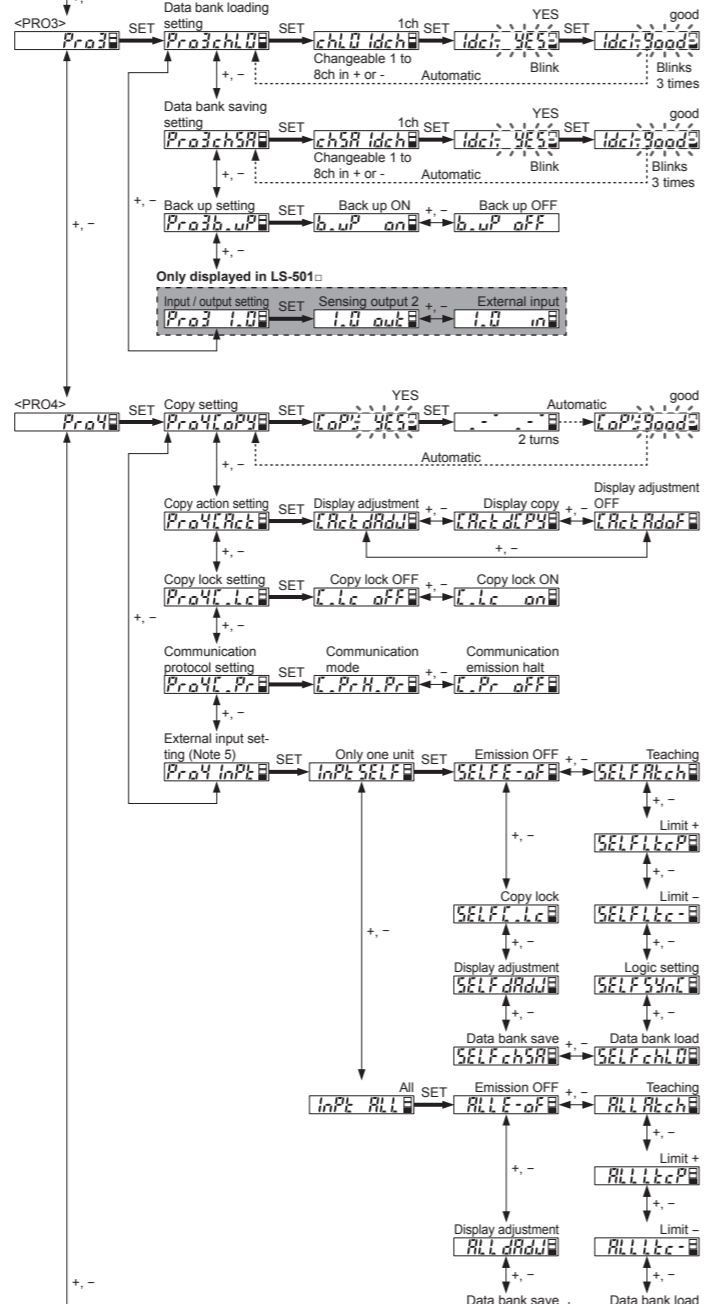
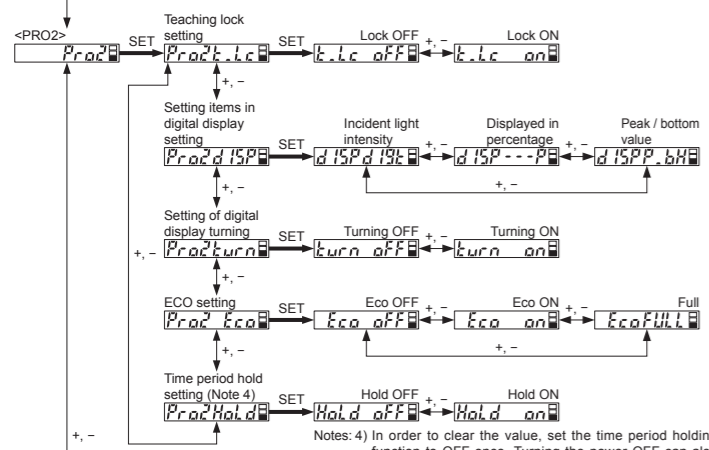
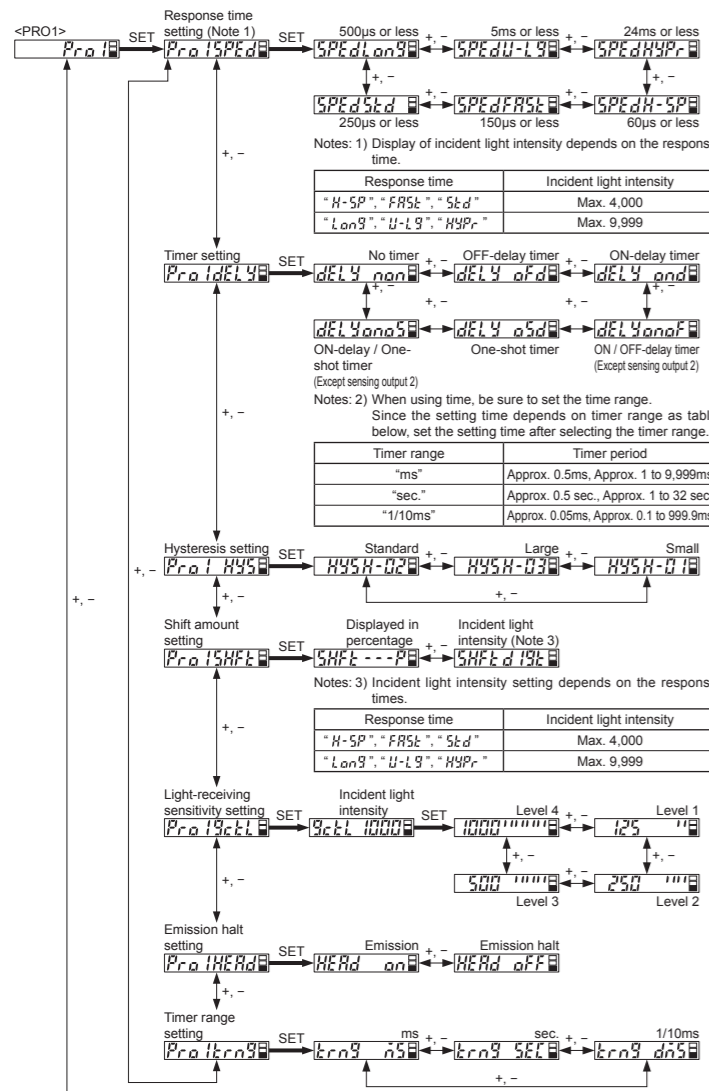

Notes: 5) The signal input time from outside is as follows.

	Input time
2 point teaching	20 to under 500ms
Limit teaching	
Display adjust	
Full auto teaching	600ms or more (sampling during input)
Emission OFF, Logic setting	2ms or more (conducted during inputting)
Copy lock	
Data bank loading	Input pulse of the specified channel number (1 pulse: 16 to 300ms). However, the pulse cycle is under 500ms.
Data bank saving	

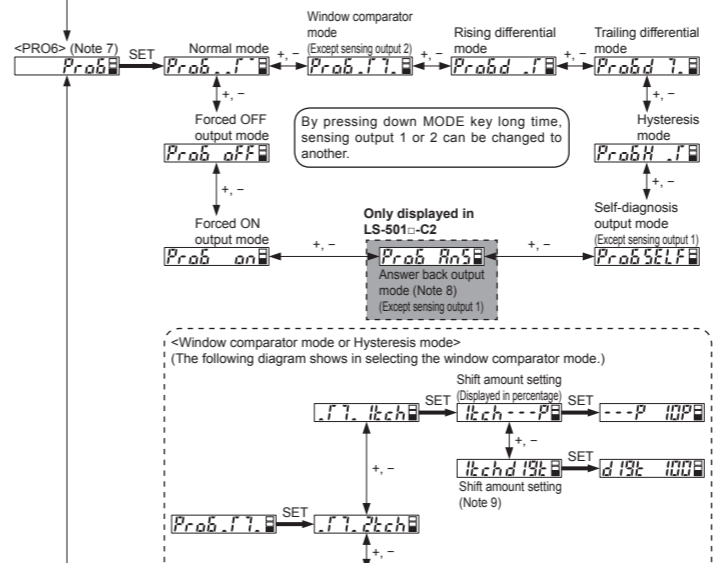
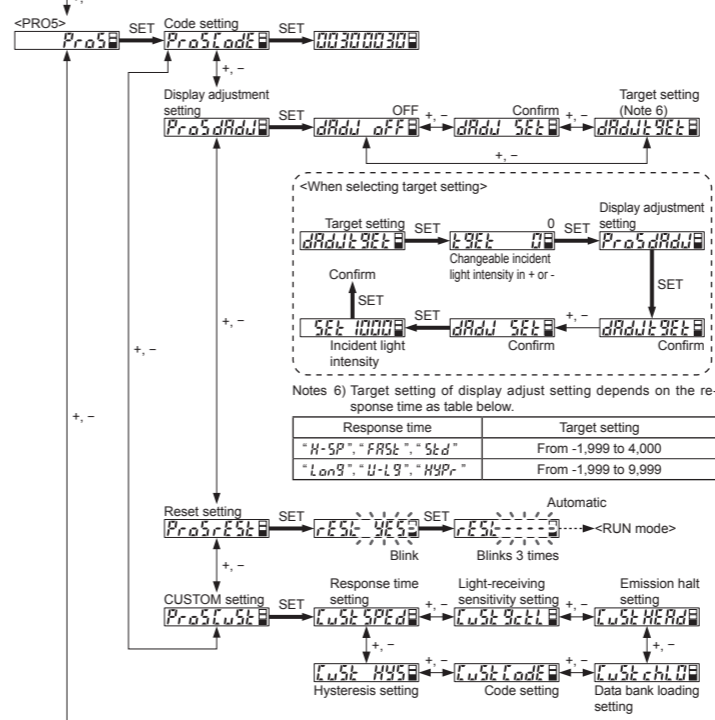

Notes: 7) Set the sensing output setting after input / output setting for LS-501..

8) After external input, the time given until an answer back output is as follows. However, in case timer of the sensing output 2 is valid, the output time is different from the following table.

	Input time
2 point teaching	After 20ms from the input end, the answer back output is read out when result of the teaching is "good".
Limit teaching	
Full auto teaching	After 20ms from the input end, the answer back output is read out.
Display adjust	
Data bank loading	After 520ms from rising of last input pulse, the answer back output (pulse) of the number of channel in the data bank is read out.
Data bank saving	

9) Incident light intensity depends on the response time as table below.

Response time	Incident light intensity
"H-5Pr", "FR5td", "5td"	Max. 4,000
"Lon9", "U-1.9", "HYPr"	Max. 9,999

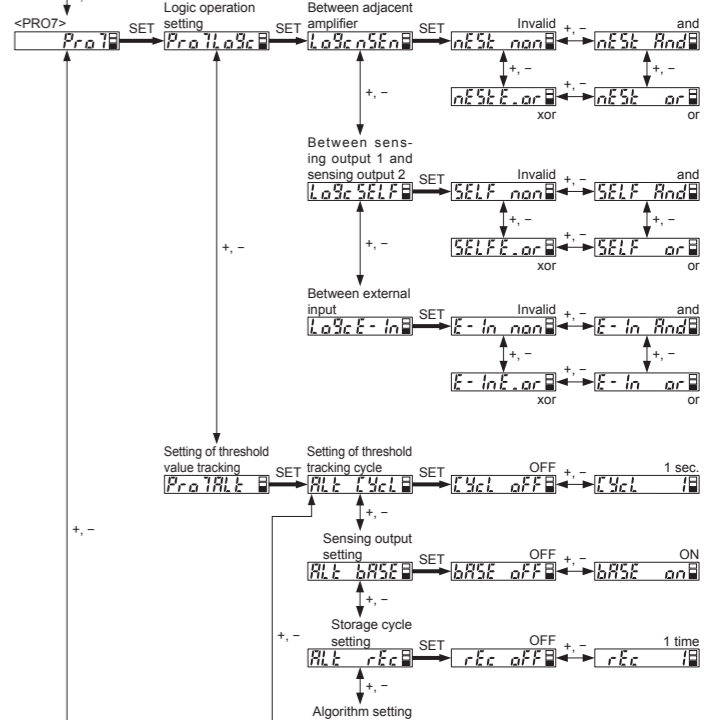

Notes: 10) In case setting to "5HFt", conduct the limit teaching for the changed incident light intensity. Shift direction of the threshold differs depending on the combination of the sensing output status and the sensing output operation.

Sensing output status	Sensing output operation	Shift direction
Sensing output ON	Light-ON	-
Sensing output ON	Dark-ON	+
Sensing output OFF	Light-ON	+
Sensing output OFF	Dark-ON	-



Item	Default setting	Description
Response time setting	5PEdLan9	Set response time.
Timer setting	dEL4nan	Set operation and period of the timer.
Hysteresis setting	HY5H-02	Hysteresis can be set when the normal mode or the window comparator mode is selected.
Shift amount setting	SHFt---P	Set shift amount of threshold value in limit teaching.
Light-receiving sensitivity setting	00000000	Selects light-receiving sensitivity from 4 levels. * 0000: Level 1 * 0000: Level 2 * 0000: Level 3 * 0000: Level 4
Emission halt setting	HEAd on	Selects laser emission from the sensor head to execute or halt.
Timer range setting	Ern9ns	Change unit time of timer.
Teaching lock setting	t-Lc oFF	Be able to prevent from wrong operation of teaching. * oFF: Teaching mode is valid * on: Teaching mode is invalid
Digital display item setting	d1SPd19t	Incident light intensity can be displayed in percentage or the peak / bottom value can be displayed on the digital display (red).
Digital display turning on setting	turn oFF	Sets the viewing orientation of the digital display.
ECO setting	Eco oFF	Power consumption can be lowered. * oFF: ECO OFF * on: If any key operation is not carried out for 20 sec. in RUN mode, the digital display turns OFF. * Full: If key operation is not done in 20 sec. or setting the key lock function in Run mode, all indicators turns OFF.
Period hold setting	Hold oFF	* oFF: Peak / bottom value in the digital display refreshing condition can be displayed. * on: Peak / bottom value in the hold condition can be displayed.
Data bank loading setting	chLd ldcH	Load a setting from specified data bank. (1 to 8 channel)
Data bank saving setting	chSR ldcH	Save a setting to specified data bank. (1 to 8 channel)
Back up setting	b.u.P on	Select to save or not to save the threshold value by teaching in EEPROM.
Input / output setting (LS-501□ only)	1.0 ouk	Select either sensing output 2 or external output.
Copy setting	-	Using optical communications, be able to copy setting contents in main amplifier to all of the sub amplifiers connected from the main amplifier. LS-501□ cannot send or receive threshold value when conducting copy.
Copy action setting	LRct dRdd	Copy of items in display adjustment setting and incident light intensity are conducted or canceled by using optical communication. In case incident light intensity does not have enough margin, automatically set optimum value. * dRdd: Display adjustment of main amplifier and sub amplifiers can be conducted. Set to the target value of display adjustment in each amplifier. * dCPY: Incident light intensity of main amplifier can be copied to sub amplifier. However, when the difference between main amplifier and sub amplifier is big, it will not be copied. * RdoF: Display adjust of main and sub amplifier can be set to OFF. Do not press down the SET key many times when display is "RdoF". When "RdoF" is not displayed in confirmation, also do not press down set key many times.
Copy lock setting	L.Lc oFF	When conducting the setting of copy setting or data bank loading / saving from the main amplifier via optical communications, it is possible that only the sub amplifier which is set to copy lock ON "L.Lc on" does not receive the set contents. However, even if copy lock ON " is set, the copy action setting is communicated.
Communication protocol setting	L.Pr.H.Pr	When conducting the copy setting or setting of data bank loading / saving from the main amplifier via optical communications, the optical communications through a sub amplifier which is set to communication emission halt "L.Pr oFF" and the following sub amplifiers can be halted.
External input setting	InPt SELF	Set external input.
Code setting	00300030	Consistent setting can be done by inputting 8-digit code instead of independent setting. In addition, present setting can be confirmed.
Display adjustment setting	dRdd oFF	Set incident light intensity to target value. If conducting display adjustment setting when incident light intensity does not have enough margin, "dUR" is blinked. * oFF: Display adjustment OFF * 5Et: Slide to (smaller side) incident light intensity from the set of target setting. * t9Et: Set incident light intensity to value you want (negative side). In case setting to 0-adjustment, set to 0.
Reset setting	-	If setting to "YES" returns to default settings (factory settings).
CUSTOM setting	LUsk 5PEd	Select an item in CUSTOM mode to display.
Sensing output mode	PrOb...f	Set sensing output 1 mode and sensing output 2 mode. * .f (Normal mode) * Sets a threshold value for ON / OFF operation. * .f1 (Window comparator mode) (Except sensing output 2) * Sets two threshold values and judges they are within the required range or not. This can be selected in 1 / 2 / 3-point teaching. * d.f (Rising differential mode) * Only drastic rises in incident light intensity are detected. * d.1 (Trailing differential mode) * Only drastic drops in incident light intensity are detected. * H.f (Hysteresis mode) * Changes hysteresis to ignore small change of incident light intensity. * This can be selected in 1 / 2 / 3-point teaching. * SELF (Self diagnosis output mode) (Except sensing output 1) * Conduct self diagnosis output * Rr5 (Answer back output mode) (Only displayed in LS-501□-C2 but except sensing output 1) * Conduct Answer back output toward external input. * on (Forced ON output mode) * Sets forcibly the output to ON. * oFF (Forced OFF output mode) * Sets forcibly the output to OFF.

Item	Default setting	Description
Logical operation setting	Lo9cn5En	Select for logical operation and set logical operation methods (and, or, xor). * n5En: Logical operation is sensing output 1 of this device and conduct logical operation between the sensing output 1 and sensing output 1 of this device. The calculation result of upper amplifiers and this product is output from the sensing output 1 of this product. * 5ELF: Logical operation is outer input and conduct logical operation between the output and sensing output 1 of this device. * E-in: Logical operation is sensing output 1 of an upper adjacent amplifier and conduct logical operation between the sensing output and sensing output 1 of this device.
Setting of threshold value tracking	L4cl oFF	This mode can change the threshold value depending on the cycle (1 to 9,999 sec.) that is set with the variations of the incident light intensity. The tracking shift amount is the one which is set at the shift setting.
Sensing output setting	bR5E oFF	Selects whether tracking threshold when the output is OFF or when the output is ON.
Storage cycle setting	rEc oFF	Selects a threshold storage cycle in EEPROM from 1 to 250 times.
Algorithm setting	Rt9 SHFt	When setting to limit teaching, threshold value is followed up on the bases of shift amount. Furthermore, when setting to auto teaching, threshold value be followed up on the bases of each cycle.

LS-501□ / Code setting table

• Green digital display (right side is the first digit)

Code	Forth digit		Code	Third digit		Code	Second digit	Code	First digit
	Sensing output operation mode	Sensing output 2		Timer operation	Sensing output 2				
0	Light-ON	Light-ON	0	No timer	No timer	0	0.5ms	0	Response time setting
1	Light-ON	Dark-ON	1	OFD	No timer	1	1ms	1	Light-receiving sensitivity setting
2	Dark-ON	Light-ON	2	OND	No timer	2	3ms	2	Emission halt setting
3	Dark-ON	Dark-ON	3	ONOF	No timer	3	5ms	3	Data bank loading setting
4	-	-	4	OSD	No timer	4	10ms	4	Code setting
5	-	-	5	ONOS	No timer	5	30ms	5	Hysteresis setting
6	-	-	6	No timer	OFD	6	50ms	6	-
7	-	-	7	No timer	OND	7	100ms	7	-
8	-	-	8	No timer	OSD	8	300ms	8	-
9	-	-	9	-	-	9	500ms	9	-
A	-	-	A	-	-	A	1 sec.	A	-
b	-	-	b	-	-	b	2 sec.	b	-
c	-	-	c	-	-	c	3 sec.	c	-
d	-	-	d	-	-	d	4 sec.	d	-
E	-	-	E	-	-	E	5 sec.	E	-

(OFD: OFF-delay timer, OND: ON-delay timer, ONOF: ON / OFF-delay timer, OSD: One-shot timer)
(ONOS: ON-delay / One-shot timer)

• Red digital display (right side is the first digit)

Code	Forth digit		Code	Third digit		Code	Second digit	Code	First digit
	Copy lock setting	Hysteresis setting		Setting items in digital display setting	Back up setting				
0	Copy lock OFF	H-02	0	Incident light intensity	Back up ON	0	H-SP	0	Normal mode
1	Copy lock ON	H-02	1	Incident light intensity	Back up OFF	1	FAST	1	WC mode
2	Copy lock OFF	H-03	2	Displayed in percentage	Back up ON	2	STD	2	Rising differential mode
3	Copy lock ON	H-03	3	Displayed in percentage	Back up OFF	3	LONG	3	Trailing differential mode
4	Copy lock OFF	H-01	4	Peak / bottom value	Back up ON	4	U-LG	4	HYS mode
5	Copy lock ON	H-01	5	Peak / bottom value	Back up OFF	5	HYPR	5	-

(WC mode: Window comparator mode, HYS mode: Hysteresis mode)

Note: It is a setting only for sensing output 1. Sensing output 2 cannot be set.

LS-501□-C2 / Code setting table

• Green digital display (right side is the first digit)

Code	Forth digit		Code	Third digit		Code	Second digit	Code	First digit
	Sensing output operation mode	Sensing output 2		Timer operation	Sensing output 2				
0	Light-ON	Light-ON	0	No timer	No timer	0	0.5ms	0	Response time setting
1	Light-ON	Dark-ON	1	OFD	No timer	1	1ms	1	Light-receiving sensitivity setting
2	Dark-ON	Light-ON	2	OND	No timer	2	3ms	2	Emission halt setting
3	Dark-ON	Dark-ON	3	ONOF	No timer	3	5ms	3	Data bank loading setting
4	-	-	4	OSD	No timer	4	10ms	4	Code setting
5	-	-	5	ONOS	No timer	5	30ms	5	Hysteresis setting
6	-	-	6	No timer	OFD	6	50ms	6	-
7	-	-	7	No timer	OND	7	100ms	7	-
8	-	-	8	No timer	OSD	8	300ms	8	-
9	-	-	9	-	-	9	500ms	9	-
A	-	-	A	-	-	A	1 sec.	A	-
b	-	-	b	-	-	b	2 sec.	b	-
c	-	-	c	-	-	c	3 sec.	c	-
d	-	-	d	-	-	d	4 sec.	d	-
E	-	-	E	-	-	E	5 sec.	E	-

(OFD: OFF-delay timer, OND: ON-delay timer, ONOF: ON / OFF-delay timer, OSD: One-shot timer)
(ONOS: ON-delay / One-shot timer)

• Red digital display (right side is the first digit)

Code	Forth digit		Code	Third digit		Code	Second digit	Code	First digit
	Copy lock setting	Hysteresis setting		Setting items in digital display setting	Back up setting				
0	Copy lock OFF	H-02	0	Incident light intensity	Back up ON	0	H-SP	0	Normal mode
1	Copy lock ON	H-02	1	Incident light intensity	Back up OFF	1	FAST	1	Normal mode
2	Copy lock OFF	H-03	2	Displayed in percentage	Back up ON	2	STD	2	Normal mode
3	Copy lock ON	H-03	3	Displayed in percentage	Back up OFF	3	LONG	3	Normal mode
4	Copy lock OFF	H-01	4	Peak / bottom value	Back up ON	4	U-LG	4	Normal mode
5	Copy lock ON	H-01	5	Peak / bottom value	Back up OFF	5	HYPR	5	Normal mode
6	-	-	6	-	-	6	-	6	WC mode
7	-	-	7	-	-	7	-	7	WC mode
8	-	-	8	-	-	8	-	8	Rising differential mode
9	-	-	9	-	-	9	-	9	HYS mode

(WC mode: Window comparator mode, HYS mode: Hysteresis mode)

Panasonic Industrial Devices SUNX Co., Ltd.

<http://panasonic.net/id/pidsx/global>

Overseas Sales Division (Head Office)

2431-1 Ushiyama-cho, Kasugai-shi, Aichi, 486-0901, Japan

Phone: +81-568-33-7861 FAX: +81-568-33-8591

[For sales network, please visit our website.]

PRINTED IN JAPAN

© Panasonic Industrial Devices SUNX Co., Ltd. 2015