

Configuration of class 210-R transmitters by keypad



Table of contents

1. INTRODUCTION.....	5
1.1. Description of the transmitter.....	5
1.2. Description of the keys.....	5
1.3. Selection of the output signal.....	6
1.4. Protection tip of the sensors.....	6
2. WARNING.....	7
2.1. Wiring.....	7
2.2. Probes.....	7
3. ACCESS TO THE DIFFERENT FUNCTIONS.....	8
4. F 100: CONFIGURE THE TRANSMITTER.....	9
4.1. Access to the firmware version.....	9
4.2. Configure the screen.....	9
4.2.1 Set the contrast: F 110.....	9
4.2.2 Set the backlight duration: F 111.....	9
4.2.3 Set the backlight.....	9
4.3. Lock the keypad: F 140.....	10
5. F 200: CHANNELS AND MEASUREMENT UNITS CONFIGURATION.....	11
6. F 300: ANALOGUE OUTPUTS MANAGEMENT.....	12
6.1. Outputs diagnostic.....	12
6.1.1 Connection configuration.....	12
6.1.2 Perform the outputs diagnostic.....	12
6.2. Set the range of the analogue outputs.....	13
6.3. Set the purge time (CP210-R).....	14
7. F 400: MANAGE THE RELAYS.....	16
8. F 500: MEASUREMENT SETTINGS.....	18
8.1. Auto-zero (CP210-R).....	18
8.2. Pressure measurement integration (CP210-R).....	18
8.3. Time-delay between two auto-zeros (CP211-R and CP212-R).....	18
8.4. Air velocity measurement integration (CTV210-R).....	19
8.5. Add an offset.....	19
9. F 600: COMPENSATION, MEANS OF MEASUREMENT AND SECTION SETTINGS.....	21
9.1. Temperature compensation (CP210-R).....	21
9.1.1 Set the unit.....	21
9.1.2 Set the temperature compensation value temperature.....	21
9.2. Altitude compensation (COT212-R, CP210-R and CTV210-R).....	21
9.3. Selection of the means of measurement.....	22
9.3.1 Select the means of measurement (CP210-R).....	22
9.3.2 Set the coefficient value of the differential pressure element (CP210-R).....	22
9.3.3 Set the correction factor value of the air velocity (CP210-R and CTV210-R).....	22
9.4. Setting of the type of section and airflow coefficient (CP210-R, CTV210-R).....	23
9.4.1 Select the type of section.....	23
9.4.2 Select the unit if the section.....	23
9.4.3 Set the size of the section.....	23
9.4.4 Set the airflow coefficient (CP210-R).....	24
10. FUNCTIONS RECAP.....	25
10.1. F 100.....	25
10.2. F 200.....	25
10.3. F 300.....	26
10.4. F 400.....	26
10.5. F 500.....	27
10.6. F 600.....	27

1. INTRODUCTION

1.1. Description of the transmitter

Class 210-R transmitters with display can be configured via keypad. It is possible to set measurement units, activate or not a channel, etc.

Principle: the configuration options are accessed via **folders and sub-folders**. Access is made via a **numerical code** (full details in this manual).

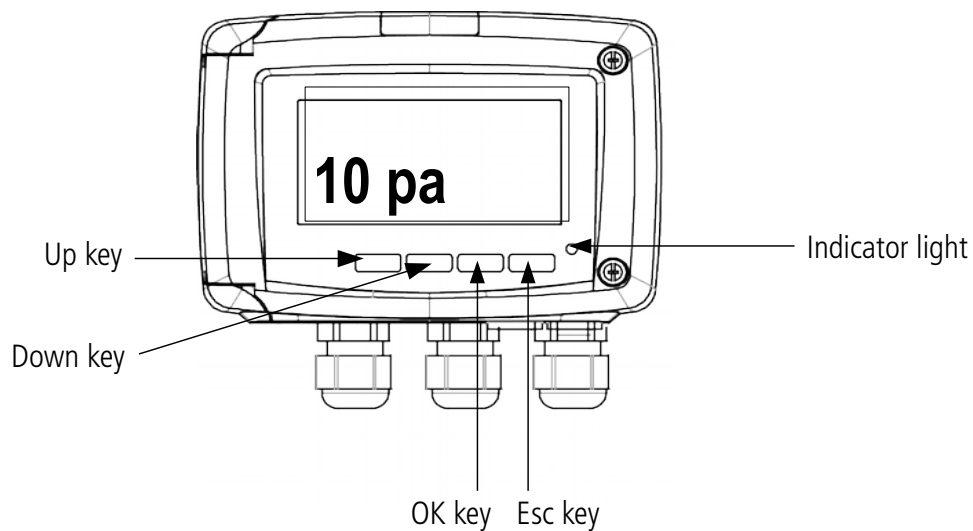

Trend indicator: on the screen, a trend indicator represented by a rising arrow, a going down arrow or a stable arrow is displayed above the measurement unit. It means the calculation of a moving average on the last hour (M1) to compare with a moving average on the last 5 minutes (M2):

- If $M1 = M2$, the trend is stable.
- If $M1 < M2$, the trend is upwards.
- If $M1 > M2$, the trend is downwards.

Indicator light: the indicator light blinks quickly during the initialisation phase of the transmitter then becomes fixed when this phase has been completed.





For the pressure transmitters with solenoid valve (CP211-R and CP212-R), it blinks when the solenoid valve is activated.

1.2. Description of the keys

- **Up key:** increments a value or a level
- **Down key:** decrements a value or a level
- **OK key:** validates an input
- **Esc key:** cancels an input or backs to the previous step

1.3. Selection of the output signal

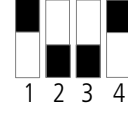
The selection of the output signal in voltage (0-10 V or 0-5 V) or in current (4-20 mA or 0-20 mA) must be performed with the transmitter **NOT ENERGISED** and is made with the DIP switch of the electronic board putting the on-off switches as shown on the table below:

Configuration	4-20 mA	0-10 V	0-5 V	0-20 mA
Combinations	 1 2 3 4	 1 2 3 4	 1 2 3 4	 1 2 3 4

1.4. Protection tip of the sensors



It's extremely unwise to remove the protection tip of our hygrometry probes as the sensitive element is very fragile even to light contacts. However, if you have to remove the protection tip, take all possible precautions and **AVOID ANY CONTACT** with the sensitive element.

To remove the protection tip, unscrew it or unclip it.

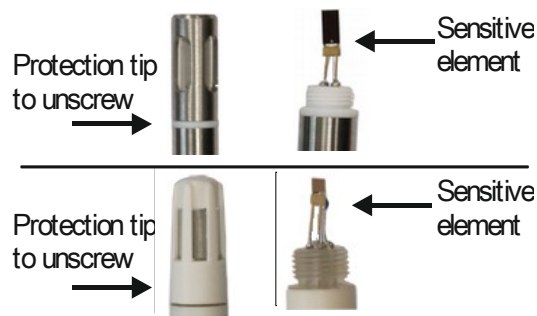

2.1. Wiring

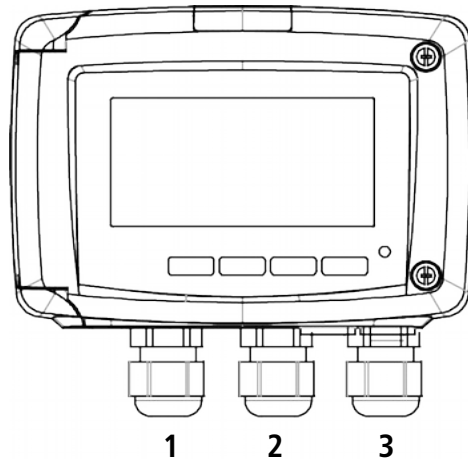

In order to avoid cross-wiring:

- **1:** this cable-gland must be reserved to **relays**
- **2:** this cable-gland must be reserved to **analogue outputs**
- **3:** this cable-gland must be reserved to **power supply**



To consider cable-glands as fixation points, the cable diameter range to place in the cable gland must be between 4 and 8 mm.



The power supply wiring must be performed with crimping copper connections or a tinning in case of multi-wire cable.

- After performing the wiring, tight the cable-glands.

For details about the different wiring possibilities, please see the data sheet of the concerned sensor.

2.2. Probes



To avoid any device damage, probes must not be subject to voltage above 30 Vac or 60 Vdc with respect to the ground.

3. ACCESS TO THE DIFFERENT FUNCTIONS



This step is compulsory for each configuration.

First, to access to the transmitter functions, and for safety, a safety code must be entered. This safety code is **0101** and **can not be modified**.

The transmitter must be energised.

- Connect the transmitter.
- Wait for the initialisation phase.
- Press **OK**.
The screen displays "Code" with "0000". The first 0 blinks.
- Press **OK** to go to the second 0.
It blinks.
- Press **Up** key to display 1 then press **OK**.
The third 0 blinks.
- Press **OK** to go to the fourth 0.
- Press **Up** key to display 1 then press **OK**.
The following screen is displayed:

Code
0101

F 100

"F 100" is for the number of the configuration folder. There are 6 folders:

- **F 100:** folder of the transmitter configuration. See page 9
- **F 200:** folder of the channels and units of measurement. See page 11
- **F 300:** folder of the analogue outputs. See page 12
- **F 400:** folder of the relays configuration. See page 16
- **F 500:** folder of the measurement configuration. See page 18
- **F 600:** folder of the measurement configuration specific to the COT212-R, CP210-R and CTV210-R transmitters. See page 21

To select the required folder:

"F 100" is displayed and 1 is blinking.

- Press **Up** key until the number of the required folder is display ("**F 100**", "**F 200**", "**F 300**", "**F 400**", "**F 500**" or "**F 600**" according to the type of transmitter).
- Press **OK**.



If a wrong code is entered, "CODE" blinks a few seconds on the bottom right of the screen then the measured values are displayed. It is necessary to enter the right code.

4. F 100: CONFIGURE THE TRANSMITTER

This folder allows to configure the following parameters of the transmitter: contrast, backlight and keypad locking. It also indicates the firmware version of the transmitter.

4.1. Access to the firmware version

The activation code is validated and "F 100" is displayed (see previous page).

- Press **OK**.
"F 101" is displayed with the firmware version number above. (Ex: 1.04)

4.2. Configure the screen

4.2.1 Set the contrast: F 110

The transmitter is powered on.

- Press **OK**.
- Enter the activation code (see page 8).
- Press **OK**.
"F 100" folder is displayed.
- Press **OK**.
- Press **Up** key to go the "F 110" folder.
"F 110" is displayed with the number corresponding to the contrast level between 0 and 5.
- Press **OK**.
The contrast number blinks.
- Set it between **0** and **5** pressing **Up** and **Down** keys.



When pressing Up or Down key to change the contrast level, there is a lag time of 1 second where the digits disappear then they reappear with the new contrast.

- Press **OK**.

4.2.2 Set the backlight duration: F 111

It is possible to set the backlight duration:

- **0**: backlight is inactive
- **1**: backlight lasts 10 s.
- **2**: backlight lasts 30 s.
- **3**: backlight lasts 60 s.
- **4**: backlight is permanent.

Backlight is activated pressing any key (unless the level 0 is selected).

"F 110" sub-folder is displayed.

- Press **Up** key.
"F 111" is displayed with the number corresponding to the backlight duration between 0 and 4.
- Press **OK**.
The backlight duration blinks.
- Set it between **0** and **4** pressing **Up** and **Down** keys.
- Press **OK**.

4.2.3 Set the backlight

"F 111" sub-folder is displayed.

- Press **Up** key.

"F 112" is displayed with the number corresponding to the backlight level between 0 and 10.

- Press **OK**.
The backlight level blinks.
- Set it between **0** and **10** pressing **Up** and **Down** keys.
- Press **OK**.

4.3. Lock the keypad: F 140

For more safety and avoid any unwanted manipulation, it is possible to lock the keys of the transmitter.

"F 112" sub-folder is displayed.

- Press Up key.
"F 140" is displayed with "OFF" meaning that the locking is deactivated.
- Press **OK**.
"OFF" blinks.
- Press **Up** or **Down** key, *"ON"* blinks, then press **OK**.
"LOCK" is displayed for a few seconds then the transmitter displays the measured values.
All the keys are inactive.
To reactivate them:
- Press for 10 seconds on **OK** key.
"LOCK" blinks for a few seconds then the measured values are displayed and the keys are activated.

5. F 200: CHANNELS AND MEASUREMENT UNITS CONFIGURATION

This folder allows to activate the channels and to configure the measurement unit for each channel.

The transmitter is powered on.

- Press **OK**.
- Enter the activation code (see page 8).
- Press **OK**.
- Press **Up** key to go to the folder "**F 200**".
- Press **OK**.
- "00" blinks and the unit corresponding to the channel 1 is displayed.*
- Press **OK**.
- The unit blinks.*
- Press **Up** and **Down** keys to select the required unit according to the type of transmitter.
- Or when "00" blinks:*
- Press **Up** or **Down** key to select the sub-folder "**F 210**" corresponding to the channel 2.
- Press **Up** and **Down** keys to select the required unit according to the type of transmitter.



"---" sign allows to deactivate the channel.

Units available according to the channel and the type of transmitter:

CP211-212-213-R: Pa, mmH₂O, inWG, mbar, mmHg, daPa, kPa, hPa, m/s*, fpm*, m³/h*, l/s*, cfm*, m³/s*, dam³/h*, °C, °F

CTV210-R: m/s, fpm, km/h, m³/h, l/s, cfm, m³/s, dam³/h, °C, °F

COT212-R: ppm, °C, °F

TM210-R: °C, °F, dT, %RH, g/kg, kJ/kg, °C Td, °F Td, °C Tw, °F Tw, g/m³

TH210-R: %RH, g/kg, kJ/kg, °C Td, °F Td, °C Tw, °F Tw, °C, °F, g/m³

*: units regarding the air velocity and airflow calculation, available on CP211-212-213-R transmitters with SQR3 option only.

6. F 300: ANALOGUE OUTPUTS MANAGEMENT

6.1. Outputs diagnostic

This function allows to check on a measurement device (multimeter, regulator or automate) the proper functioning of the outputs. The transmitter will generate a voltage (between 0 and 10 V) or a current (between 0 and 20 mA) according to the setting of the DIP switch of the transmitter electronic board.

- For a 0-10 V output signal, the transmitter will generate 0 – 5 or 10 V.
- For a 0-5 V output signal, the transmitter will generate 0 – 2.5 or 5 V.
- For a 4-20 mA output signal, the transmitter will generate 4 – 12 or 20 mA.
- For a 0-20 mA output signal, the transmitter will generate 0 – 10 or 20 mA.

6.1.1 Connection configuration



Before carrying out the output diagnostics, all connections and configurations of the transmitter must be enabled, to avoid any damage on the transmitter and the measurement device!

- Select a channel for the outputs diagnostic.
OUT1 or OUT2, indicated on the electronic board above the terminal blocks.
- Connect a measurement device on the channel 1 or on the channel 2.

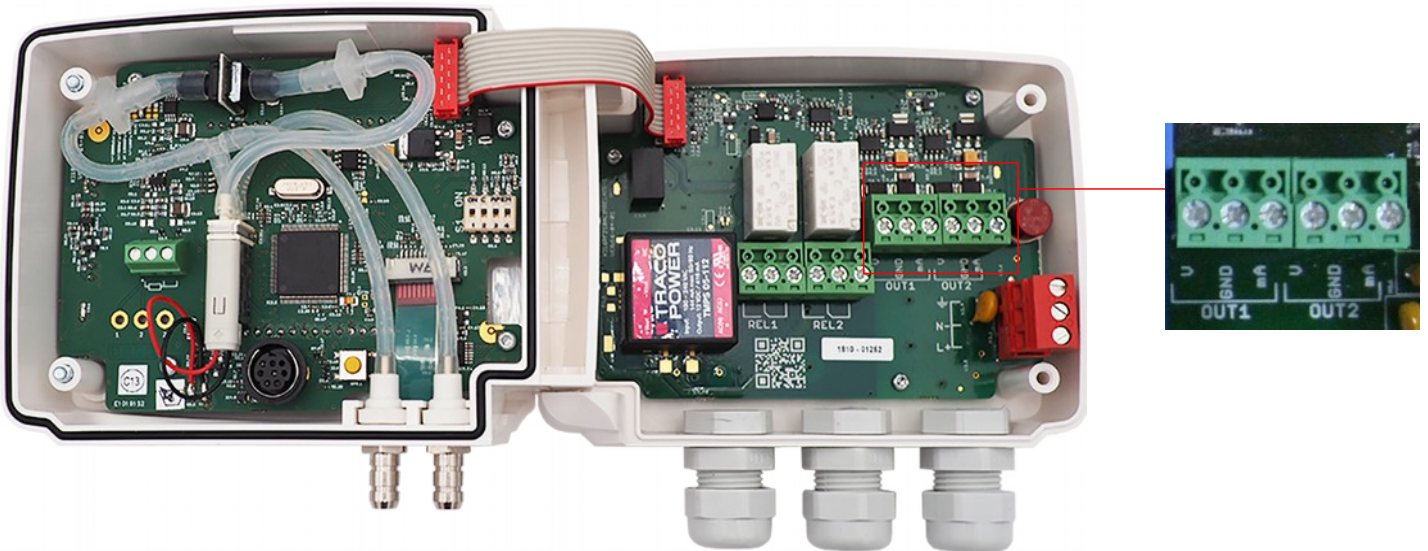

6.1.2 Perform the outputs diagnostic

Once the connection to the measurement device is complete, the outputs diagnostic on several check points can be performed:

The transmitter is powered on.

- Press **OK**.
- Enter the activation code (see page 8).
- Press **OK**.
- Press **Up** key to go to the **"F 300"** folder.
- Press **OK**.
- **"F 301"** blinks, corresponding to the diagnostic of the **channel 1**.
- Press **OK**.
- Press **Up** and **Down** keys to select the signal that the transmitter has to generate.

Screen	Generated output	Example
0	Deactivated	-
1	Simulates 0% of the output range	On the 0-10V range, the transmitter will generate 0V.
2	Simulates 50% of the output range	On the 0-10V range, the transmitter will generate 5V.
3	Simulates 100% of the output range	On the 0-10V range, the transmitter will generate 10V.



If the deviations are too large ($> 0.05V$ or $> 0.05mA$) between the signal issued and the value displayed on the multimeter, we recommend to return the transmitter to our factory.

- For the diagnostic of the **channel 2**, go to "**F 311**" folder and do the same procedure as the channel 1.

6.2. Set the range of the analogue outputs

This function allows to modify the range of the analogue outputs.



Values to enter depend on the measurement unit and not on the measurement range of the transmitter.

Ex: on a CP211-R pressure transmitter (0 to ± 1000 Pa) with a reading in mmH_2O , the minimum and maximum ranges must be configured on measuring range of 0 to ± 102 mmH_2O . See **conversion chart on page 15**.

The transmitter is powered on.

- Press **OK**.
- Enter the activation code (see page 8).
- Press **OK**.
- Press **Up** key to go to folder "**F 302**" corresponding to the low range of the channel 1.
- Press **OK**.

The first digit of the low range blinks.

- Enter with **Up** and **Down** keys the figure value or the negative sign of the value then press **OK**.

The second digit blinks.

- Enter with **Up** and **Down** keys its value then press **OK**.
 - Perform the same procedure for the following figures.
 - Press **OK** when the last figure has been configured.
- "F 302" blinks, the low range is configured.*

- Press **Up** key then press **OK** to enter in the folder "**F 303**" corresponding to the high range of the channel 1.

The first digit of the high range blinks.

- Enter with **Up** and **Down** keys the figure value or the negative sign of the value then press **OK**.

The second digit blinks.

- Enter with **Up** and **Down** keys its value then press **OK**.
 - Perform the same procedure for the following figures.
 - Press **OK** when the last figure has been configured.
- "F 303" blinks, the high range is configured.*



To set the low and high ranges of the channel 2, go to the folders "**F 312**" (low range) and "**F 313**" (high range) and follow the setting procedure of the channel 1.

6.3. Set the purge time (CP210-R)

The purge mode enables to freeze the measurement when being displayed, enables to lock the analogue outputs, and to activate the relay 1, in order to actuate a de-dust system of an air movement conditions system and to activate the relay 2 in order to isolate the transmitter.

Here is the detailed process of the purge mode:

1. Measurement is frozen.
2. Wait for 3 seconds.
3. Activation of the relay 2 (isolation of the transmitter).
4. Wait for time-delay (for example: 10 seconds).
5. Activation of the relay 1 (sending compressed air into the network to clean the installation).
6. Purge duration (for example: 30 seconds).
7. Deactivation of the relay 1 (stop sending compressed air).
8. Wait for time-delay (for example: 10 seconds).
9. Deactivation of the relay 2.
10. Wait for 3 seconds.
11. Recovery of the measurement.

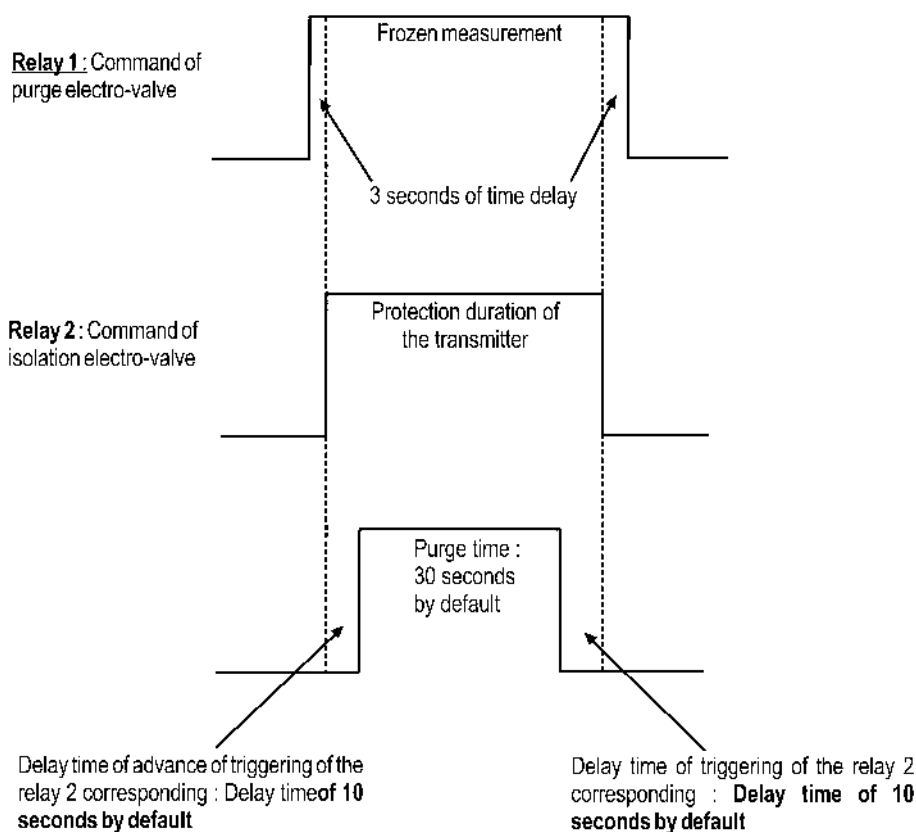

The transmitter is powered on.

- Enter the activation code (see page 8).
- Press **OK**.
- Press **Up** key to go to the "**F 300**" folder.
- Press **OK**.
- Press **Up** key to go to the "**F 390**" folder corresponding to the purge mode setting.
- Press **OK**.
- With the **Up** and **Down** keys, select **ON** to activate the purge mode or **OFF** to deactivate it.
- Press **OK**.
- Press **Up** key to go to the "**F 391**" folder corresponding to the purge duration setting.
- Press **OK**.

- With the **Up** and **Down** keys, set the purge duration from 1 to 60 seconds.
- Press **OK**.
- Press **Up** key to go to the **"F 392"** folder corresponding to the duration between two purges.
- Press **OK**.
- With **Up** and **Down** keys, set the duration between two purges from 1 to 9999 minutes.
- Press **OK**.
- Press the **Up** key to go to the **"F 393"** folder corresponding to the delay setting.
- Press **OK**.
- With **Up** and **Down** keys, set the delay from 1 to 60 seconds.
- Press **OK**.



The purge duration must be between 1 and 60 seconds.
The duration between 2 purges must be between 1 and 9999 minutes.
The delay duration must be between 1 and 60 seconds.

Unit of measurement conversion chart

- **Pressure**

	Pa	mmH ₂ O	InWG	mbar	mmHG	kPa	PSI	daPa	hPa
CP211-R	±100	±10.2	±0.40	±1.00	±0.75	±0.100	-	±10.0	±1.00
CP212-R	±1000	±102.0	±4.01	±10.00	±7.50	±1.000	-	±100.0	±10.00
CP213-R	±10 000	±1019.7	±40.14	±100.00	±75.00	±10.000	-	±1000.0	±100.00

- **Temperature**

TH210-R	°C	°F
Ambient model	From 0.0 to +50.0	From +32.0 to +122.0
Model with polycarbonate probe	From -20.0 to +80.0	From -4.0 to +176.0
Model with stainless steel probe	From -40.0 to +180.0	From -40.0 to +356.0

TM210-R	°C	°F
Ambient model	From 0.0 to +50.0	From +32.0 to +122.0
Terminal block model	From -100.0 to +400.0	From -148.0 to +752.0

CTV210-R / COT212-R	°C	°F
Ambient model	From 0.0 to +50.0	From +32.0 to +122.0

CP210-R	°C	°F
On terminal block	From -100.0 to +400.0	From -148.0 to +752.0

- **Air velocity**

CTV210-R	m/s	fpm	km/h
Standard	From 0 to 30	From 0 to 5905	From 0 to 108

7. F 400: MANAGE THE RELAYS

When the transmitter is still in alarm state, the relay goes off and activates its negative or positive security according to its configuration.

Three relays activation modes are available:

- **Rising edge (1 threshold):** the relay goes off when the measurement **exceeds** the threshold and stops when it is **below** the threshold.
- **Falling edge (1 threshold):** the relay goes off when the measurement is **below** the threshold and stops when it **exceeds** the threshold.
- **Monitoring (2 thresholds):** the relay goes off when the measurement is outside the defined low and high thresholds.

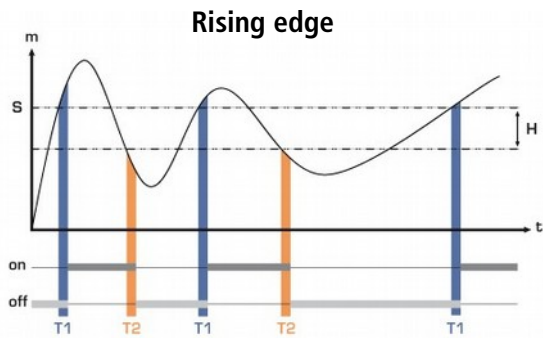

Measurement (m) > Threshold (S) during the time-delay T1 → Relay activation
 Measurement (m) < Threshold (S) - Hysteresis (H) during the time-delay T2 → Relay deactivation

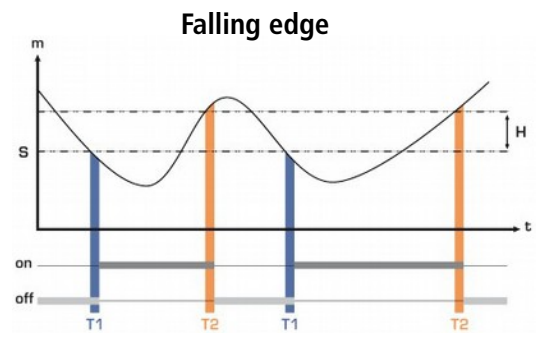

Measurement (m) < Threshold (S) during time-delay T1 → Relay activation.
 Measurement (m) > Threshold (S) + Hysteresis (H) during time-delay T2 → Relay deactivation

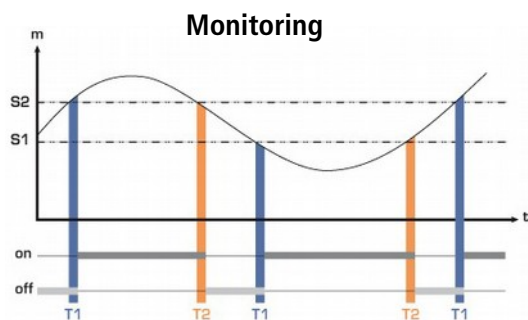

The relay goes off when the measurement is outside the low and high thresholds.



It is possible to set 2 different relays activation:

- **"F 400"** folder corresponds to the **relay 1** setting
- **"F 410"** folder corresponds to the **relay 2** setting

The relay setting procedure explained below corresponds to the relay 1 setting. For the relay 2 setting, go to the corresponding folder and perform the same procedure as for the relay 1.

The transmitter is powered on.

- Press **OK**.
- Enter the activation code (see page 8).
- Press **OK**.
- Press the **Up** key to go to the **"F 400"** folder.
- Press **OK**.

This folder corresponds to the activation relay mode.

- With **Up** and **Down** keys, select the required relay activation mode:

- **0/3**: relay is deactivated
 - **1/3**: rising edge mode
 - **2/3**: falling edge mode
 - **3/3**: monitoring mode
- Press **OK**.
"F 400" blinks.
 - Press **Up** key to go to the **"F 401"** folder of relay 1 (**"F 411"** for relay 2) then press **OK**.
 - With **Up** and **Down** keys, select the channel where the relay will be activated.
 - Press **OK**.
"F 401" blinks.
 - Press **Up** key to go to the **"F 402"** folder (**"F 412"** for relay 2) then press **OK**.
*This folder corresponds to the **threshold 1** settings.*
 - Set the **threshold 1** with the **Up** and **Down** keys.
 - Press **OK** when the last digit has been set.
"F 402" blinks.
 - Press **Up** key to go to the **"F 403"** folder (**"F 413"** for relay 2) then press **OK**.
This folder concerns:
 - For a rising or falling edge: **hysteresis setting**
 - For a monitoring: **threshold 2 setting**
 - Set the hysteresis or threshold 2 with the **Up** and **Down** keys.
 - Press **OK** when the last digit has been set.
"F 403" blinks.
 - Press **Up** key to go to the **"F 404"** folder (**"F 414"** for relay 2) then press **OK**.
*This folder corresponds to the **delay 1** setting.*
 - Set the delay 1 with the **Up** and **Down** keys.
 - Press **OK** when the last digit has been set.
"F 404" blinks.
 - Press the **Up** key to go to the **"F 405"** folder (**"F 415"** for relay 2) then press **OK**.
*This folder corresponds to the **delay 2** setting.*
 - Set the delay 2 with **Up** and **Down** keys.
 - Press **OK** when the last digit has been set.
"F 405" blinks.
 - Press **Up** key to go to the **"F 406"** folder (**"F 416"** for relay 2) then press **OK**.
*This folder corresponds to the relay safety. The relay outputs are by default, in **negative security**: the relay is energized when a set point is reached. With the keypad, you can swap the relays in **positive security**: then, the relay is de-energised when a set point is reached or during a power outage.*
 - Activate or deactivate the safety relay with **Up** and **Down** keys.
 - **1**: positive safety
 - **0**: negative safety
 - Press **OK** to confirm.

8. F 500: MEASUREMENT SETTINGS

In order to compensate a potential drift of the transmitter, it is possible to add an offset to value displayed by the transmitter.

Adding an offset is only possible for the measured parameters (temperature, humidity, pressure, air velocity, ...). It is not possible to add one for the calculated parameters (airflow, psychrometry,...).

8.1. Auto-zero (CP210-R)

Class 210 pressure transmitters have an auto-zero which guarantees a good reliability of the measurement in high and low ranges.

The auto-zero compensates for any long-term drifts of the sensitive element, with the manual adjusting of the zero.

To perform a self-calibration:

- Unplug the 2 pressure connection tubes.
- Press auto-zero button. (See "**Connection**" on the data sheet).



If the instrument has a display, it is possible to perform an auto-zero pressing for 3 seconds the "Esc" key. "AutoZ" is displayed briefly meaning the auto-zero has been well performed.



On the CP211-R and CP212-R transmitters, it is not necessary to unplug the 2 pressure connection tubes (see chapter 8.3).

8.2. Pressure measurement integration (CP210-R)



This function is available on CP210-R transmitters only.

The pressure measurement element is very sensitive and reacts to pressure changes. When making measurements in unstable air movement conditions, the pressure measurement may fluctuate. The integration coefficient (from 0 to 9) makes an average of the measurements; this helps to avoid any excessive variations and guarantees a stable measurement.

New displayed value = $(((10 - \text{Coef.}) \times \text{New value}) + (\text{Coef.} \times \text{Old value})) / 10$

Example: CP212-R (0-1000 Pa) – Current measurement: 120 Pa – New measurement: 125 Pa

The pressure source being stable, the user selects a low integration. Integration: 1, maximum admitted variation ± 10 Pa. The variation is lower than 10 Pa, it is possible to apply the integration calculation formula.

Next displayed value: $((9 * 125) + (1 * 120)) / 10 = 124.5$ i.e, 124 Pa. If the new measurement had been 131 Pa, the next displayed value would have been 100% of the new value i.e, 131 Pa.

The transmitter is powered on.

- Press **OK**.
- Enter the activation code (see page 8).
- Press **OK**.
- Press **Up** key to go to folder "**F 500**".
- Press **OK**.
- Set the integration value with **Up** and **Down** keys.
This value must be between 0 and 9 with:
 - **Coefficient 0:** no integration, important fluctuation of the displayed value.
 - **Coefficient 9:** maximum integration, more stable measurement display.

8.3. Time-delay between two auto-zeros (CP211-R and CP212-R)

On transmitters having a solenoid valve for auto-zero (CP211-R and CP212-R), it is possible to set an interval between 2 auto-zeros:

The transmitter is powered on.

- Press **OK**.
- Enter the activation code (see page 8).
- Press **OK**.
- Press **Up** key to go to folder "**F 500**".
- Press **OK**.
- Press **Up** key to go to folder "**F 510**".
- Press **OK**.

The duration between two auto-zeros is displayed.

- Set it with **Up** and **Down** keys.
This time-delay must be between 0 (no auto-zero) and 60 minutes.
- Press **OK** to validate the duration.

8.4. Air velocity measurement integration (CTV210-R)



This function is available on CTV210-R transmitters only.

The air velocity measurement element of the class 210 is very sensitive and reacts to air velocity changes. When making measurements in unstable air systems, the air velocity measurement may fluctuate. The integration coefficient (from 0 to 9) makes an average of the measurement; this helps to avoid any excessive variations and guarantees a stable measurement.

New displayed value = $(((10 - \text{Coef.}) \times \text{New value}) + (\text{Coef.} \times \text{Old value})) / 10$

Example: CTV210-R with hot wire (0-30 m/s) – Current measurement: 2 m/s – New measurement: 8 m/s

The air velocity source being unstable, the user selects a strong integration. Integration: 7. The variation is lower than 10 m/s, it is possible to apply the integration calculation formula.

Next displayed value: $((2 \times 8) + (7 \times 2)) / 10 = 3 \text{ m/s.}$

The transmitter is powered on.

- Press **OK**.
- Enter the activation code (see page 8).
- Press **OK**.
- Press **Up** key to go to folder "**F 501**".
- Press **OK**.
- Set the integration value with **Up** and **Down** keys.
This value must be between 0 and 9 with:
 - **Coefficient 0:** no integration, important fluctuation of the displayed value.
 - **Coefficient 9:** maximum integration, more stable measurement display.

8.5. Add an offset

The transmitter is powered on.

- Press **OK**.
- Enter the activation code (see page 8).
- Press **OK**.
- Press **Up** key to go to folder "**F 500**".
- Press **OK**.
"F 521" blinks, corresponding to the setting folder for the main parameter.
- Press **OK**.
The first number of the offset blinks.
- Enter with **Up** and **Down** keys the number value or the negative sign of the value then press **OK**.
The second number blinks.
- Enter with **Up** and **Down** keys its value then press **OK**.

- Repeat the procedure for the following numbers.
- Press **OK** when the last number is set.
"F 521" blinks, the offset for the main parameter is configured.

- Press **Up** key then press **OK** to enter in the **"F 531"** folder corresponding to the offset of the second parameter.
The first number of the offset blinks.
- Enter with **Up** and **Down** keys the number value or the negative sign of the value then press **OK**.
The second number blinks
- Enter with **Up** and **Down** keys its value then press **OK**.
- Repeat the procedure for the following numbers.
- Press **OK** when the last number is set.
"F 531" blinks, the offset for the main parameter is configured.



The unit of the offset is set by default and can not be modified. If this unit is not the same than the unit of measurement, a conversion must be done.

9. F 600: COMPENSATION, MEANS OF MEASUREMENT AND SECTION SETTINGS

9.1. Temperature compensation (CP210-R)

It is possible to modify the temperature compensation. Indeed the air velocity and airflow measured with a differential probe (such as Pitot tube, Debimo blade, orifice plate...) depends on the working temperature. Then, it is required to enter the **working temperature** to get more accurate results.

9.1.1 Set the unit

The transmitter is powered on.

- Press **OK**.
- Enter the activation code (see page 8).
- Press **OK**.
- Press **Up** key to go to "**F 600**" folder.
- Press **OK**.
- Select **0** for °C or **1** for °F then press **OK**.

9.1.2 Set the temperature compensation value temperature

The transmitter is powered on.

- Press **OK**.
- Enter the activation code (see page 8).
- Press **OK**.
- Press **Up** key to go to "**F 602**" folder.
- Press **OK**.

The 1st digit blinks.

- Press **Up** or **Down** key to set the temperature sign: **0** for a **positive temperature** or **-** for a **negative temperature**.
- Press **OK**.

The 2nd digit blinks.

- Press **Up** or **Down** key to set the digit then press **OK**.
- Repeat the procedure for the following digits.
- Press **OK** when the last digit has been set to validate the temperature compensation value.

9.2. Altitude compensation (COT212-R, CP210-R and CTV210-R)

If measurements are performed at a specific altitude, it is advised to set the altitude in which the transmitter is.

The transmitter is powered on.

- Press **OK**.
- Enter the activation code (see page 8).
- Press **OK**.
- Press **Up** key to go to "**F 605**" folder.
- Press **OK**.

The 1st digit blinks.

- Press **Up** or **Down** to set the digit: **only 1 and 0 are available**.
- Press **OK**.

The 2nd digit blinks.

- Press **Up** and **Down** key to set the digit then press **OK**.
- Repeat the procedure to set the following digits.
- Press **OK** when the last digit has been set to validate the altitude value.

9.3. Selection of the means of measurement

The calculation of air velocity being calculated from the pressure (for a CP210-R transmitter) and from a differential pressure element, the used differential pressure element must be selected to perform the measurements. The coefficient of this element and the air velocity correction coefficient must be then entered.

9.3.1 Select the means of measurement (CP210-R)

The transmitter is powered on.

- Press **OK**.
- Enter the activation code (see page 8).
- Press **OK**.
- Press **Up** key to go to "F 610" folder.
- Press **OK**.
- Select **0, 1, 2 or 3** for:
 - **0**: Pitot L tube
 - **1**: Pitot S tube
 - **2**: Debimo blade
 - **3**: Factor

9.3.2 Set the coefficient value of the differential pressure element (CP210-R)

The transmitter is powered on.

- Press **OK**.
- Enter the activation code (see page 8).
- Press **OK**.
- Press **Up** key to go to "F 611" folder.
- Press **OK**.
- Set the 1st digit with **Up** and **Down** keys then press **OK** to set the 2nd digit.
- Repeat the procedure to set the following digits.
- Press **OK** when the last digit has been set to validate the coefficient.



This coefficient is between 0.0000 and 9.9999.

9.3.3 Set the correction factor value of the air velocity (CP210-R and CTV210-R)

The transmitter is powered on.

- Press **OK**.
- Enter the activation code (see page 8).
- Press **OK**.
- Press **Up** key to go to "F 612" folder.
- Press **OK**.
- Set the 1st digit with **Up** and **Down** keys then press **OK** to set the 2nd digit.
- Repeat the procedure to set the following digits.
- Press **OK** when the last digit has been set to validate the factor.



This coefficient is between 0.000 and 2.000

9.4. Setting of the type of section and airflow coefficient (CP210-R, CTV210-R)



This function is available for CP210-R transmitters with SQR3 option only.

9.4.1 Select the type of section

The transmitter is powered on.

- Press **OK**.
- Enter the activation code (see page 8).
- Press **OK**.
- Press **Up** key to go to "**F 620**" folder.
- Press **OK**.
- Select **0, 1, or 2** for:
 - **0**: rectangular section
 - **1**: circular section
 - **2**: coefficient*

9.4.2 Select the unit if the section

The transmitter is powered on.

- Press **OK**.
- Enter the activation code (see page 8).
- Press **OK**.
- Press **Up** key to go to "**F 621**" folder.
- Press **OK**.
- Select **0 or 1** for:
 - **0**: section in mm
 - **1**: section in inch

9.4.3 Set the size of the section

For a rectangular section:

The transmitter is powered on.

- Press **OK**.
- Enter the activation code (see page 8).
- Press **OK**.
- Press **Up** key to go to "**F 622**" folder to set **the length of the rectangular section**.
- Press **OK**.
- Set the length with **Up** and **Down** keys.
- Press **OK** when the last digit has been set to validate the length.
- Press **Up** key to go to "**F 623**" folder to set **the width of the rectangular section**.
- Press **OK**.
- Set the width with **Up** and **Down** keys.
- Press **OK** when the last digit has been set to validate the width.

For a circular section:

The transmitter is powered on.

- Press **OK**.
- Enter the activation code (see page 8).
- Press **OK**.
- Press **Up** key to go to "**F 624**" folder to set the diameter of the circular section.
- Press **OK**.

- Set the diameter with **Up** and **Down** keys.
- Press **OK** when the last digit has been set to validate the diameter.

*CP210-Only 9.4.4 Set the airflow coefficient (CP210-R)



This function is available on CP210-R with SQR3 option only.

This coefficient allows to calculate an airflow from the pressure. It is indicated by the manufacturer that supplies air vents with pressure connections (+ and -). From the square root of the measured pressure (Delta P), and this coefficient, you will get the airflow: $Airflow = C_D \sqrt{\Delta \text{ pressure}}$

The transmitter is powered on.

- Press **OK**.
- Enter the activation code (see page 8).
- Press **OK**.
- Press **Up** key to go to "**F 625**" folder to set the coefficient value.
- Press **OK**.
- Set the coefficient with **Up** and **Down** keys.
- Press **OK** when the last digit has been set to validate the coefficient.



This coefficient must be between 0000.0 and 9999.9.

- Press **Up** key to go to "**F 626**" folder to set the unit of measurement.
- Press **OK**.
- Select **0, 1, 2, 3** or **4** for:
 - **0:** Pa
 - **1:** mmH₂O
 - **2:** inWG
 - **3:** mbar
 - **4:** mmHG

10. FUNCTIONS RECAP

10.1. F 100

Code	Description	Possibilities
F 101	Firmware version	-
F 110	Screen contrast	From 0 to 5
F 111	Backlight duration	From 0 to 4
F 112	Screen backlight	From 0 to 10
F 140	Keypad locking	Off

10.2. F 200

Code	Description	Possibilities
F 200	Change unit channel 1 / deactivation of the channel	According to the type of transmitter (see below)
F 210	Change unit channel 2 / deactivation of the channel	According to the type of transmitter (see below)

Units available according to the channel and the type of transmitter:

CP211-212-213-R: Pa, mmH₂O, inWG, mbar, mmHg, daPa, kPa, hPa, m/s*, fpm*, m³/h*, l/s*, cfm*, m³/s*, dam³/h*, °C, °F

CTV210-R: m/s, fpm, km/h, m³/h, l/s, cfm, m³/s, dam³/h, °C, °F

COT212-R: ppm, °C, °F

TM210-R: °C, °F, dT, %RH, g/kg, kJ/kg, °C Td, °F Td, °C Tw, °F Tw, g/m³

TH210-R: %RH, g/kg, kJ/kg, °C Td, °F Td, °C Tw, °F Tw, °C, °F, g/m³



“---” sign allows to deactivate the channel.

*: units regarding the air velocity and airflow calculation, available on CP211-212-213-R transmitters with SQR3 option only.

10.3. F 300

Code	Description	Possibilities				
F 301	Diagnostic of the channel 1: generation of current or voltage	Display	Generation according to the output signal			
			0-10 V	0-5 V	0-20 mA	4-20 mA
		0	no generation			
		1	0 V	0 V	0 mA	4 mA
		2	5 V	2.5 V	10 mA	12 mA
3	10 V	5 V	20 mA	20 mA		
F 302	Low range of the channel 1	According to the type of transmitter				
F 303	High range of the channel 1	According to the type of transmitter				
F 311	Diagnostic of the channel 2: generation of current or voltage	Display	Generation according to the output signal			
			0-10 V	0-5 V	0-20 mA	4-20 mA
		0	no generation			
		1	0 V	0 V	0 mA	4 mA
		2	5 V	2.5 V	10 mA	12 mA
3	10 V	5 V	20 mA	20 mA		
F 312	Low range of the channel 2	According to the type of transmitter				
F 313	High range of the channel 2	According to the type of transmitter				
F 390	Purge mode	ON: activated OFF: deactivated				
F 391	Purge duration	From 1 to 60 seconds				
F 392	Duration between two purges	From 1 to 9999 minutes				
F 393	Delay	From 1 to 60 seconds				

10.4. F 400

Code	Description	Possibilities
F 400	Activation mode of relay 1	0: None 1: Rising edge 2: Falling edge 3: Monitoring
F 401	Channel selection relay 1	0: Channel 1 1: Channel 2
F 402	Threshold 1 relay 1 setting	According to the connected probe
F 403	Threshold 2 or hysteresis relay 1 setting	According to the connected probe
F 404	Delay 1 relay 1 setting	From 0 to 600 seconds
F 405	Delay 2 relay 1 setting	From 0 to 600 seconds

F 406	Safety relay 1	ON: Positive safety / OFF: Negative safety
F 410	Activation mode for relay 2	0: None 1: Rising edge 2: Falling edge 3: Monitoring
F 411	Channel selection relay 2	0: Channel 1 1: Channel 2
F 412	Threshold 1 relay 2 setting	According to the connected probe
F 413	Threshold 2 or hysteresis relay 2 setting	According to the connected probe
F 414	Delay 1 relay 2 setting	From 0 to 600 seconds
F 415	Delay 2 relay 2 setting	From 0 to 600 seconds
F 416	Safety relay 2	ON: Positive safety OFF: Negative safety

10.5. F 500

Code	Transmitter	Description	Possibilities
F 500	CP210-R only	Integration of the measurement (pressure)	From 0 to 9
F 501	CTV210-R only	Integration of the measurement (air velocity)	From 0 to 9
F 510	CP210-R with solenoid valve only	Time-delay between two auto-calibrations	From 0 to 60 minutes
F 521	All	Offset main parameter	According to the measurement range of the transmitter
F 531	All	Offset secondary parameter	According to the measurement range of the transmitter

10.6. F 600

Code	Transmitter	Description	Possibilities
F 600	CP210-R	Temperature unit	0: °C 1: °F
F 602	CP210-R	Temperature compensation	
F 605	COT212-R, CP210-R and CTV210-R	Altitude compensation	
F 610	CP210-R	Means of measurement	0: Pitot L 1: Pitot S 2: Debimo blade 3: Factor
F 611	CP210-R	Differential pressure coefficient	
F 612	CP210-R and CTV210-R	Factor of air velocity	

		correction	
F 620	CP210-R and CTV210-R	Type of section	0: Rectangular 1: Circular 2: Coefficient*
F 621	CP210-R and CTV210-R	Unit of the section	0: mm 1: inch
F 622	CP210-R and CTV210-R	Rectangular section length	
F 623	CP210-R and CTV210-R	Rectangular section width	
F 624	CP210-R and CTV210-R	Circular section diameter	
F 625	CP210-R	Airflow coefficient	
F 626	CP210-R	Unit of measurement	0: Pa 1: mmH ₂ O 2: inWG 3: mbar 4: mmHG

*CP210-R only.

